



**INSTITUTO POTOSINO DE INVESTIGACIÓN
CIENTÍFICA Y TECNOLÓGICA, A.C.**

POSGRADO EN CIENCIAS EN BIOLOGIA MOLECULAR

**La acetiltransferasa de histonas TGF-1 es el
coactivador de genes inducibles por la luz azul
en *Trichoderma atroviride***

Tesis que presenta
Edith Elena Uresti Rivera

Para obtener el grado de
Doctora en Ciencias en Biología Molecular

Director de la Tesis:
Dr. J. Sergio Casas Flores

San Luis Potosí, S.L.P., agosto de 2013



Constancia de aprobación de la tesis

La tesis "**La acetiltransferasa de histonas TGF-1 es el coactivador de genes inducibles por la luz azul en *Trichoderma atroviride***" presentada para obtener el Grado de Doctora en Ciencias en Biología Molecular fue elaborada por **Edith Elena Uresti Rivera** y aprobada el **3 de julio de 2013** por los suscritos, designados por el Colegio de Profesores de la División de Biología Molecular del Instituto Potosino de Investigación Científica y Tecnológica, A.C.

Dr. J. Sergio Casas Flores
Director de la tesis

Dra. Irene Beatriz Castaño Navarro
Miembro del Comité Tutorial

Dr. Alejandro De Las Peñas Nava
Miembro del Comité Tutorial

Dr. Alfredo Heriberto Herrera Estrella
Miembro del Comité Tutorial



Créditos Institucionales

Esta tesis fue elaborada en el Laboratorio de Genómica Funcional y Comparativa de la División de Biología Molecular del Instituto Potosino de Investigación Científica y Tecnológica, A. C., bajo la dirección del Dr. J. Sergio Casas Flores.

La investigación descrita en esta tesis fue financiada con recursos otorgados al Dr. Alfredo Herrera Estrella y al Dr. Sergio Casas Flores por el proyecto SEP-CONACYT **83798**

Durante la realización del trabajo el autor recibió una beca académica del Consejo Nacional de Ciencia y Tecnología con número de registro **206894** y del Instituto Potosino de Investigación Científica y Tecnológica, A. C. con número de oficio: **SA-139/2013**

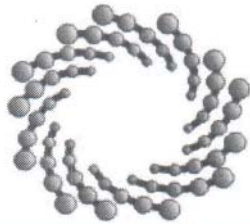

IPICYT

Instituto Potosino de Investigación Científica y Tecnológica, A.C.

Acta de Examen de Grado

El Secretario Académico del Instituto Potosino de Investigación Científica y Tecnológica, A.C., certifica que en el Acta 057 del Libro Primero de Actas de Exámenes de Grado del Programa de Doctorado en Ciencias en Biología Molecular está asentado lo siguiente:

En la ciudad de San Luis Potosí a los 1 días del mes de agosto del año 2013, se reunió a las 12:40 horas en las instalaciones del Instituto Potosino de Investigación Científica y Tecnológica, A.C., el Jurado integrado por:

Dr. Alfredo Heriberto Herrera Estrella	Presidente	CINVESTAV Irapuato
Dra. Irene Beatriz Castaño Navarro	Secretaria	IPICYT
Dr. Alejandro De Las Peñas Nava	Sinodal	IPICYT
Dr. J. Sergio Casas Flores	Sinodal	IPICYT

a fin de efectuar el examen, que para obtener el Grado de:

DOCTORA EN CIENCIAS EN BIOLOGÍA MOLECULAR

sustentó la C.

Edith Elena Uresti Rivera

sobre la Tesis intitulada:

La acetiltransferasa de histonas TGF-1 es el coactivador de genes inducibles por la luz azul en Trichoderma atroviride

que se desarrolló bajo la dirección de

Dr. J. Sergio Casas Flores

El Jurado, después de deliberar, determinó

APROBARLA

Dándose por terminado el acto a las 14:35 horas, procediendo a la firma del Acta los integrantes del Jurado. Dando fe el Secretario Académico del Instituto.

A petición de la interesada y para los fines que a la misma convengan, se extiende el presente documento en la ciudad de San Luis Potosí, S.L.P., México, a los 1 días del mes de agosto de 2013.

Dr. Marcial Bonilla Marín
Secretario Académico

Mtra. Ivonne Lizette Cuevas Vélez
Jefa del Departamento del Posgrado

Dedicatorias

*A mis padres
A mis hermanos
A mis sobrinos
A todos mis amigos*

“Todo aquél que está seriamente comprometido con el cultivo de la ciencia, llega a convencerse de que en todas las leyes del Universo está de manifiesto un espíritu infinitamente superior al hombre, y ante el cual, nosotros con nuestros poderes, debemos sentirnos humildes”

(Albert Einstein)

“I have not failed. I've just found 10,000 ways that won't work”

(Thomas Alva Edison)

Agradecimientos

Debo agradecer primeramente a Dios, por todas Sus bendiciones y por haberme concedido la oportunidad de concluir una etapa más de mi vida.

A mis padres, por darme la vida y por todos los sacrificios que hicieron y siguen haciendo y que me han permitido llegar hasta aquí.

Al Dr. Sergio Casas por todos estos años como su estudiante y por sentar las bases de mi formación científica.

A mis sinodales, el Dr. Alejandro de Las Peñas y la Dra. Irene Castaño. Muchas gracias por su valioso apoyo en la revisión de mi tesis y por todas sus enseñanzas y valiosas aportaciones a mi trabajo a lo largo de esta etapa en el IPICT.

Al Dr. Alfredo Herrera, por haber aceptado ser parte de mi comité tutorial y por sus atinados comentarios y sugerencias que mejoraron la redacción de esta tesis.

Al Dr. Gerardo Argüello, por todo su apoyo, sus consejos tanto científicos como personales que me ayudaron muchísimo durante el doctorado. Es usted un gran ser humano, un gran investigador y sobre todo, un excelente amigo.

A la Dra. Lina Riego, por sus consejos, observaciones y comentarios en el laboratorio y en mis seminarios y sus pláticas amenas.

A mis actuales compañeros y a aquellos que alguna vez formaron parte de este grupo de trabajo: Aída, Elida, Gema, Gerardito, Chuy, Liz, Macario, Magnolia, Mayte, Miguel Ángel Salas, Miguel Ángel Silva, Sandra, Tania, Yazmín, Zayra y la Dra. Magda. Fue un verdadero placer haber compartido con ustedes tantos buenos momentos en el laboratorio y fuera de él; me llevo recuerdos muy bonitos y grandes amigos que enriquecieron mi vida.

A mis otros compañeros del Laboratorio de Genómica Funcional y Comparativa. Excelentes tiempos compartidos y excelentes personas y amigos: Paco, Javier, Peresson, Bere, Ángel y Cintia.

A la Ing. María Isabel Isordia Jasso. Por todo su apoyo técnico y por su amistad. Gracias, Chabelita.

A la señora Rosy y Claudia Adriana, que sin ellas, el trabajo diario en el laboratorio simplemente no saldría adelante.

A todos los que fueron mis compañeros de la DBM durante los años que pasé en el IPICT; en especial y con mucho cariño a Mariana Cantú, Yair, Ángel Huerta, Hugo, Raúl, Marcela, Jacky, Omar, Marbella, Ivón Solís, Guardalupe, Candy, Josefat,

Pablo Delgado, Berna, Gaby Mendoza, Paco Ramírez y Liz Cortés. Los estimo y aprecio y agradezco todos los ratos de diversión que compartimos.

A todos mis compañeros y amigos de otras divisiones, así como a los profesores, técnicos y personal administrativo con quienes tuve la oportunidad de compartir charlas en los pasillos, torneos, organizaciones de congreso, concursos de la canción, etc. No hay ninguno de todos ustedes de los que no haya aprendido algo.

Al Dr. Vladimir Escobar, por el enorme apoyo y toda la ayuda que me brindó y por los consejos que me ayudaron y me siguen ayudando en mi vida personal y profesional. Gracias además por su valiosa amistad.

A la Dra. Claudia Escudero, por sus ánimos y alientos para terminar este proyecto, su paciencia, su ayuda, sus consejos y por ser una de las personas con más calidad humana que conozco.

A Vincent, por el apoyo y los ánimos que me ha brindado en este último año.

A mis amigos de siempre: Vero, Magdis, Erika Ojeda, Georgina, Claudia Martínez, Alejandro Ramos, Mayra Nelly, Guillermo Juárez y Mariana Haydeé.

Al IPICYT por permitirme realizar mis estudios de maestría y doctorado.

Al CONACYT, por otorgarme la beca durante mis estudios de posgrado.

Contenido

Constancia de aprobación de la tesis	ii
Créditos institucionales	iii
Acta de examen	iv
Dedicatorias	v
Agradecimientos	vi
Abreviaturas	x
Resumen	xi
Abstract	xii
Introducción	1
1. La luz y sus efectos en los seres vivos	1
1.1. Percepción de la luz roja	2
1.2. Percepción de la luz verde	3
1.3. Percepción de la luz azul	4
1.3.1 Respuestas a la luz azul en los hongos	6
2. Fotobiología de <i>Trichoderma/Hypocrea</i> spp.	9
2.1 Efecto de la luz, el AMPc y los nutrientes en <i>Trichoderma/Hypocrea</i>	13
2.2 Efecto de la luz en la síntesis de los peptaiboles y de los metabolitos secundarios.	13
2.3 Participación de la proteína cinasa A (PKA) en respuesta a luz azul	14
2.4 La luz azul y las proteínas G heterotriméricas	14
3. Estructura de la cromatina	15
4. Acetilación de las histonas	15
4.1 La proteína Gcn5p, su actividad como acetiltransferasa de histonas y su papel como coactivador	17
5. Estudios sobre la modificación covalente de las histonas inducidas por la luz azul	17

Contenido

Justificación	19
Objetivo general	19
Objetivos particulares	19
Resultados parte I	20
Resultados parte II	26
Discusión	59
Conclusiones	66
Perspectivas	67
Anexos	68
Bibliografía	112

Abreviaturas

ADN	Ácido desoxirribonucleico
ATP	Adenosín Trifosfato
ARN	Ácido ribonucleico
cDNA	DNA complementario
AMPc	Adenosín mono fosfato cíclico
ChIP	Inmunoprecipitación de la Cromatina
D-WCC	Complejo White Collar en oscuridad
ELRE	Elementos de respuesta temprana a la luz
FAD	Flavín Adenín Dinucleótido
FMN	Flavin Adenin Mononucleótido
H3	Histona 3
H4	Histona 4
HDAC	Desacetilasa de histonas
HAT	Acetil transferasa de histonas
L-WCC	Complejo White Collar en luz
LLRE	Elementos de respuesta tardía a la luz
R/IR	Rojo/Rojo lejano
kb	Kilobases
LOV	Luz, Oxígeno, Voltaje
LRR	Región de respuesta a la luz
µg	Microgramos
µmol	Micromol
µM	Micromolar
nM	Nanomolar
nm	Nanómetros
PAS	Per, Arnt, Sim
pb	Pares de bases
PCR	Reacción en cadena de la polimerasa
PDA	Agar Papa y Dextrosa
PDB	Caldo de Papa y Dextrosa,
PEG	Polietilen glicol
rpm	Revoluciones por minuto
qRT-PCR	Transcripción reversa-PCR cuantitativa
RT-PCR	Transcripción reversa-PCR
s	Segundos
TSA	Trichostatin A
UVA	Luz ultravioleta tipo A
UVB	Luz ultravioleta tipo B
WB	Western blot
WCC	Complejo White Collar

Resumen

La acetiltransferasa de histonas TGF-1 es el coactivador de genes inducibles por la luz azul en *Trichoderma atroviride*

En el hongo filamentoso *Neurospora crassa*, las proteínas White Collar 1 y 2 (WC-1 y WC-2) regulan todas las respuestas a luz azul descritas hasta ahora. La proteína WC-1 es el fotorreceptor y junto con la proteína WC-2 con la que forma un complejo regulador, fungen como factores transcripcionales de los genes inducibles por luz azul. La acetil transferasa de histonas NGF-1 es el coactivador de genes de respuesta a luz azul e interacciona físicamente con WC-1 para regular la fotorespuesta. En *Trichoderma*, las proteínas ortólogas a WC-1 y WC-2 son BLR-1 y BLR-2 respectivamente, que también regulan respuestas a la luz, formando un complejo en el que, presumiblemente, BLR-1 actúa como el fotorreceptor. En el presente trabajo se demostró que la luz azul induce la acetilación global de la histona H3. La mutante del gen *tgf-1*, el cual codifica probablemente para una acetil transferasa de histonas, presenta un fenotipo pleiotrópico, afectando especialmente el crecimiento y desarrollo de *T. atroviride*. Diversos análisis transcripcionales y de inmunoprecipitación de la cromatina (ChIP) demostraron que la proteína TGF-1 es un coactivador de genes que responden a luz azul, probablemente a través de la acetilación de los residuos de lisina K9 y K14 de la histona H3 que forma parte de la cromatina asociada a los promotores de dichos genes. Demostramos también que se requiere de TGF-1 en la oscuridad para mantener los niveles basales del gen *bld-2* (blue light down regulated 2) que está regulado negativamente por luz azul. Además se requiere, después de un pulso de luz azul, de la presencia de TGF-1 para llevar a cabo la acetilación transitoria de la histona H3 del promotor del gen *phr-1*.

Palabras clave: *Trichoderma*, luz azul, acetilación, TGF-1, Proteínas BLR

Abstract

The histone acetyltransferase TGF-1 is the coactivator of blue light inducible genes in *Trichoderma atroviride*

In the filamentous fungus *Neurospora crassa*, the White Collar -1 and 2 proteins (WC-1 and WC-2) regulate all known responses to blue light. The WC-1 protein is the photoreceptor and together with WC-2 function as transcription factors of blue light inducible genes. The histone acetyltransferase NGF-1, the orthologue of Gcn5 from *Saccharomyces cerevisiae*, is the co-activator of blue light induced genes in *N. crassa* and physically interacts with WC-1 to regulate blue light response. In *Trichoderma*, the WC-1 and WC-2 orthologues, BLR-1 and BLR-2, regulate as well blue light responses. BLR-1 has been proposed as the blue light receptor. Here we show that blue light induced a global acetylation of histone H3. Deletion of *tgf-1*, which encodes a putative acetyl transference, the orthologue of NGF-1, led to a pleiotropic phenotype, mainly affecting growth and development. Transcription and Chromatin immunoprecipitation (ChIP) analyses showed that TGF-1 is the co-activator of blue light regulated genes, probably by acetylating the K9 and K14 lysine residues of histone H3 on the promoters in *T. atroviride*. Furthermore, we demonstrate that TGF-1 is necessary to maintain the basal level of expression of *bld-2* in the dark. TGF-1 was necessary for histone H3 acetylation of the promoter of *phr-1* (blue light upregulated) after a blue light pulse, since the Δ *tgf-1* mutant showed no histone H3 acetylation on the *phr-1* promoter.

Key words: *Trichoderma*, blue light, acetylation, TGF-1, BLR proteins

INTRODUCCIÓN

1. La luz y sus efectos en los seres vivos

La luz juega un papel muy importante en el comportamiento y desarrollo de los seres vivos, ya que además de aportar energía para la fotosíntesis en las plantas, las bacterias y las algas, es fundamental para regular el desarrollo y la fisiología de los mismos. Durante el transcurso de la evolución, los seres vivos han desarrollado sofisticados mecanismos para percibir y responder a la cantidad, la calidad y la dirección de la luz. La percepción de la señal luminosa se lleva a cabo por los fotorreceptores, los cuales son complejos proteína-cromóforo. Los cromóforos son moléculas pequeñas de naturaleza no proteica que ejercen el papel de cofactores; algunos ejemplos de cromóforos son: Flavin Adenín Mononucleótido (FMN), Flavin Adenín Dinucleótido (FAD) y las porfirinas, entre otros (Cheng *et al.*, 2004; Herrera-Estrella y Horwitz, 2007). La energía proveniente de la luz es percibida por los receptores, lo que ocasiona un cambio conformacional en el cromóforo y esto provoca que la proteína adopte un estado activo (Chen *et al.*, 2004; Ko *et al.*, 2007). En el estado activo, el fotorreceptor transduce la señal luminosa hacia efectores que a su vez regulan la expresión de genes que desencadenan las respuestas fisiológicas en la célula (Froehlich *et al.*, 2002; Chen *et al.*, 2004; Ko *et al.*, 2007).

Los efectos de la señal luminosa sobre los seres vivos han sido ampliamente estudiados desde principios del siglo XVII, cuando Sebastiano Poggioli describió los efectos de la luz roja y de la luz violeta en las hojas de la planta *Mimosa pudica* (Tomado de Schäfer y Nagy, 2006). Posteriormente, Charles Darwin describió que la luz azul induce una respuesta fototrópica en las plantas al utilizar una solución amarillo-anaranjada de dicromato de potasio como filtro de la luz, evitando así la respuesta (Darwin, 1881). Actualmente, se sabe que la luz regula procesos metabólicos y del desarrollo en los hongos, las algas, las bacterias y los mamíferos (Linden *et al.*, 1997; Iseki *et al.*, 2002; Jiao *et al.*, 2007; Cashmore, 2003).

Si bien, se han descrito una gran variedad de respuestas biológicas derivadas de la acción de casi todo el espectro de la luz visible, la mayoría de ellas son atribuidas a las regiones comprendidas entre el rojo/rojo lejano (R/IR), azul/ultravioleta tipo A (UV-A) o ultravioleta tipo B (UV-B) (Briggs y Huala, 1999).

1.1 Percepción de la luz roja

Las moléculas que perciben la luz roja son denominados fitocromos. Estos, se describieron por primera vez en las plantas y se componen de un péptido y una molécula de tetrapirrol lineal (fitocromobilina) unida covalentemente por medio de una cisteína conservada en el dominio de unión al cromóforo. Estos fotorreceptores se pueden encontrar en dos formas interconvertibles en la célula: una forma Pr que absorbe luz roja ($\lambda = 660$ nm) y una forma Pfr que absorbe luz roja lejana ($\lambda = 730$ nm) (Chen *et al.*, 2004). La forma Pr de los fitocromos se localiza en el citoplasma y se transloca al núcleo después de la fotoconversión a su forma activa Pfr (Yamaguchi *et al.*, 1999; Kircher *et al.*, 1999; Nagy y Schäfer, 2000). Son pocos los organismos en los que se ha estudiado el efecto de la percepción, transducción de la señal y respuestas a la luz roja; esto se debe a que no en todos los organismos analizados se ha encontrado una respuesta en el rojo, o bien, no se han identificado las secuencia que codifique un fotorreceptor en su genoma que responda al rojo.

En las plantas, por ejemplo, la luz roja es importante para la germinación de la semillas, la fotomorfogénesis y los ritmos circadianos (Jiao *et al.*, 2007; Chen *et al.*, 2004). En *Arabidopsis thaliana*, se han descrito 5 fitocromos (PHY-A, -B, -C, -D y -E) que regulan todas las respuestas asociadas a la luz roja (Chen *et al.*, 2004; Jiao *et al.*, 2007).

En los hongos, se ha reportado que en *Aspergillus nidulans*, la luz roja activa la reproducción asexual y reprime la reproducción sexual (Mooney y Yager, 1990). Esta respuesta se lleva a cabo por un fitocromo denominado FphA, que tiene como cromóforo al tetrapirrol (biliverdina), el cual absorbe la luz roja-rojo lejana y se

localiza en el citoplasma (Blumenstein *et al.*, 2005). En el genoma de *N. crassa*, se identificaron 2 genes que codifican para 2 fitocromos putativos (PHY-1 y PHY-2), los cuales al igual que en *A. nidulans* unen tetrapirrol como cromóforo y pueden efectuar un fotociclo *in vitro* (Froehlich *et al.*, 2005); sin embargo, las mutantes simples o dobles en estos genes no presentaron un fenotipo asociado a la luz (Froehlich *et al.*, 2005). En *Trichoderma atroviride* la exposición a luz roja ocasiona una disminución en el crecimiento micelial y altera la transcripción de algunos genes (Casas-Flores *et al.*, 2004; Rosales-Saavedra *et al.*, 2006). *T. atroviride* contiene en su genoma un gen que codifica para un fitocromo similar a los descritos en *N. crassa* y en *A. Nidulans*, el cual podría ser el responsable de las respuestas al rojo.

1.2 Percepción de la luz verde

Los fotorreceptores en los animales incluyen a las opsinas, las cuales absorben en el verde ($\lambda = 534 \text{ nm}$). Estos receptores presentan siete dominios transmembranales, unen al retinol como cromóforo y sus actividades se han visto asociadas a las proteínas G. Las opsinas de las bacterias y los hongos están relacionadas estructuralmente a las de los animales, debido a que son proteínas de membrana y todas contienen los 7 dominios transmembranales; sin embargo, no presentan homología entre ellas a nivel de la secuencia de aminoácidos (Kateriya *et al.*, 2004; Bieszke *et al.*, 1999). En las plantas, se ha demostrado que la luz verde promueve efectos muy discretos y opuestos a los generados por la acción de la luz roja o azul (Folta y Maruhnich, 2007). En *Vicia faba* se demostró que un breve pulso de luz verde podía evitar el efecto de apertura de estomas causado por un pulso de luz azul (Frechilla *et al.*, 2000). En las bacterias y las algas, las opsinas pueden tener funciones sensoriales o actuar como canales iónicos regulados por la luz (Kateriya *et al.*, 2004). En el hongo *N. crassa*, el gen *nop-1* codifica para una opsina que une trans-retinal como cromóforo, formando un pigmento foto-activo que absorbe la luz visible con un pico máximo de absorción de 534 nm (luz verde) (Bieszke *et al.*, 1999). NOP-1 modula la carotenogénesis y reprime a los genes involucrados en la conidiación en *N. crassa* (Bieszke *et al.*, 2007). En el hongo

Leptosphaeria maculans se encontró el gen homólogo a *nop-1*, sin embargo, no se le ha descrito una función (Idnurm y Howlett, 2001). En *T. atroviride* la percepción de la luz verde no ha sido muy estudiada, pero se sabe que su genoma contiene una secuencia que codifica para un posible fotorreceptor tipo opsina que podría unir rodopsina para percibir la luz verde. La secuencia de aminoácidos presenta un porcentaje de identidad del 46% con NOP-1 de *N. crassa* (Casas-Flores y Herrera-Estrella, 2013)

1.3 Percepción de la luz azul

La luz azul y la UV-A presentan las longitudes de onda más cortas ($\lambda = 320$ a 400 nm) dentro del intervalo de la luz visible y sus frecuencias de ondas electromagnéticas son más altas; y también presentan una mayor cantidad de energía y al reaccionar con moléculas biológicas como las flavinas, las porfirinas, las clorofilas, las quinonas, las bilirrubinas y el retinal, generan la formación de oxígeno singulete (1O_2). El oxígeno en singulete y las especies reactivas de oxígeno (ERO) resultantes provocan daño a todas las biomoléculas como el ADN, los lípidos y las proteínas (Lledias y Hansberg, 2000). Ésta, es la razón por la cual la luz azul es percibida en los organismos como una señal de “alerta” que induce la activación de mecanismos de defensa y protección, como son la producción de pigmentos, la síntesis de enzimas para responder al estrés oxidante y la formación de estructuras de resistencia (esporas) para la perpetuación de la especie (Linden *et al.*, 1997; Ma *et al.*, 2001; Rosales-Saavedra *et al.*, 2006; Berrocal-Tito *et al.*, 2007). Algunas de las respuestas biológicas reportadas por el efecto de la luz azul son: el fototropismo en las plantas y los hongos, la inhibición del alargamiento del hipocotilo, la apertura de los estomas, la migración de cloroplastos en las plantas (Kaufman *et al.*, 1993; Linden *et al.*, 1997; Briggs y Christie, 2002), la inducción de la síntesis de carotenoides en hongos (Rau y Mitzka-Schnabel, 1985), y el encarrilamiento del ritmo circadiano en diversos organismos (Gehring y Rosbash, 2003).

Los fotorreceptores que perciben a la luz azul UV-A unen flavinas (FMN o FAD), pterinas o dezaflavina como cromóforo (Herrera-Estrella y Horwitz, 2007). En *Arabidopsis thaliana* se describió por primera vez un tipo de receptor de la luz azul denominado criptocromo. El gen, que codifica para una fotoliasa, tenía además una mutación que confería defectos en la señalización de luz azul (Ahmad y Cashmore, 1993). En *A. thaliana*, se han descrito 3 criptocromos (CRY-1, CRY-2 y CRY-3), los cuales tienen una extensión de aminoácidos en el extremo carboxilo-terminal, que actúa como un dominio efector, para activar las respuestas inducidas por la luz azul. Se ha descrito también que los criptocromos tienen un papel adicional esencial dentro del reloj circadiano en *Drosophila* y mamíferos (Cashmore, 2003).

En *A. thaliana* también se describieron las fototropinas, PHO-1 y PHO-2, que son receptores de la luz azul. Estas fototropinas tienen dos dominios LOV (luz, oxígeno, voltaje) en su región amino terminal, una molécula de FMN unida por una interacción no covalente en los dominios LOV y un dominio de cinasa en el extremo carboxilo-terminal (Briggs y Christie, 2002) (Figura 1B). En la oscuridad el dominio LOV-2 interacciona con el dominio de cinasa, para mantenerlo inactivo. La luz azul induce la unión covalente entre el FMN y una cisteína conservada en el dominio LOV, que conlleva a un cambio conformacional, que permite la activación del dominio de cinasa (Chen *et al.*, 2004).



Figura 1. A) Arquitectura de los distintos tipos de criptocromo presentes en diversos organismos. PHR indica fotoliasa o región similar a la fotoliasa. MTHF (Metil tetra-hidro folato); FAD (Flavín Adenín Dinucleótido) **B)** Representación esquemática de las fototropinas de plantas. Arreglo estructural de dos dominios: el dominio output que presenta un dominio cinasa hacia el carboxilo terminal y dos dominios LOV (luz, oxígeno, voltaje) hacia el amino terminal que une FMN (Flavín mono nucleótido). Las flechas indican las regiones de fosforilación (Tomado y modificado de Demarsy *et al*, 2009 y McGraw-Hill Global Education Holdings, LLC.)

1.3.1 Respuestas a la luz azul en los hongos

Debido a su relativa simplicidad, los hongos filamentosos han sido utilizados como modelos para entender los mecanismos que participan en la percepción de la señal luminosa. En los hongos filamentosos, la luz regula la conidiación, el fototropismo, el desarrollo sexual, el encarrilamiento del ritmo circadiano, y el metabolismo secundario, entre otros procesos (Herrera-Estrella y Horwitz, 2007). Aunque se conocen respuestas reguladas por la luz roja, la luz ultravioleta y la luz verde, como la conidiación en los hongos *Aspergillus nidulans* (Purschwitz *et al.*, 2005), *Alternaria tomato* (Kumagai, 1989) y *Alternaria solani* (Klein, 1992), la mayoría de las respuestas a la luz en hongos se deben a la luz azul (Herrera-Estrella y Horwitz, 2007).

El hongo *Neurospora crassa* ha sido el modelo para el estudio de la percepción de la señal luminosa. Todas las respuestas descritas a luz azul se han atribuido al complejo fotorreceptor de luz azul, el cual está integrado por las proteínas **W**hite **C**ollar -1 (WC-1) y **W**hite **C**ollar -2 (WC-2). Mutantes en los genes *wc-1* o *wc-2* que codifican para WC-1 y WC-2, eliminan todas las respuestas conocidas a la luz azul en este hongo (Ballario *et al.*, 1996; Linden y Macino, 1997). Las proteínas WC son factores de transcripción que presentan dominios de dedos de zinc de unión a ADN tipo GATA, de localización nuclear y de activación de la transcripción (Ballario *et al.*, 1998). Además, WC-1 presenta tres dominios PAS (Per-Arnt-Sim) (PAS-A, -B, -C), involucrados en detectar señales intra y extracelulares, de los cuales el primero pertenece a una subfamilia de dominios PAS especializados en percibir señales como **L**uz **O**xígeno y **V**oltaje (LOV). El dominio LOV de WC-1 une de manera covalente al nucleótido FAD como cromóforo, de forma similar a como se ha descrito para las fototropinas de las plantas (Froehlich *et al.*, 2002; He *et al.*, 2002). Los dos dominios PAS restantes tienen un papel importante en la formación de homo y heterodímeros con el único dominio PAS de la proteína WC-2, para formar el complejo White Collar (WCC) (Cheng *et al.*, 2002, 2003). El WCC actúa como activador transcripcional de los genes que responden de manera temprana y tardía a la luz azul (Linden *et al.*, 1997; Lewis *et al.*, 2002). Como ejemplos de genes de respuesta temprana son *frq*, *al-3*, *con-6*, *con-10*, *bli* y varios genes del reloj circadiano (*ccgs*) (Linden *et al.*, 1997). La expresión de los genes de respuesta temprana se observa durante los primeros 5 min después del pulso de luz azul y alcanzan una inducción máxima entre los 15 y los 30 min. Por otro lado, la inducción de los genes de respuesta tardía como *ccg-1* y *ccg-2*, se observa después de los 15 min de inducción y alcanzan su máximo a las 2 h (Arpaia *et al.*, 1993, 1995; Lewis *et al.*, 2002). La rápida inducción de los genes tempranos se debe a que son blancos directos del WCC, el cual se une a secuencias conservadas en los promotores, denominadas elementos de respuesta temprana a luz (ELRE) (Froehlich *et al.*, 2002; He y Liu 2005, Chen *et al.*, 2009). Los genes de respuesta tardía no son blancos directos de las proteínas WC; sino que son regulados por genes de respuesta temprana como *sub-1* (codifica para un factor transcripcional), que se une

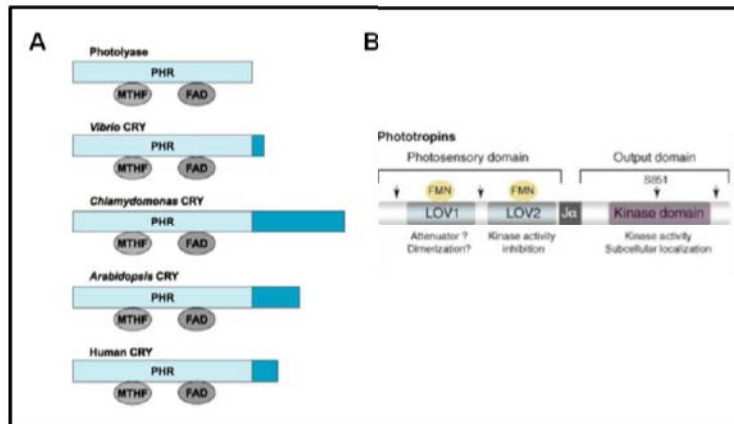
a los elementos de respuesta tardía (LLRE) presentes en los promotores de los genes tardíos (Chen *et al.*, 2009).

El gen *vvd*, el cual es un gen de respuesta temprana, codifica para el fotorreceptor secundario VVD que contiene un dominio LOV y una FAD como cromóforo. La proteína VVD es considerada como un receptor de luz azul secundario y se requiere para la fotoadaptación y para detectar cambios en la intensidad de luz. (Schwerdtfeger y Linden, 2003). VVD depende de WCC para su expresión pero también VVD regula de manera negativa al complejo WCC al interactuar físicamente con el dominio LOV de WC-1, estableciendo así, un circuito regulatorio negativo mediado por la luz (Chen *et al.*, 2010).

Se ha demostrado que las proteínas WC se fosforilan en la oscuridad. La proteína WC-1 se hiperfosforila de manera dependiente de la luz azul, con un patrón comparable a la cinética de expresión de los genes responsivos a luz (Froehlich *et al.*, 2002; He y Liu, 2005). Esta fosforilación se ha asociado con la inactivación del complejo WC, así como a la degradación del fotorreceptor WC-1. Este proceso es considerado como fundamental para la foto-adaptación (He y Liu, 2005). La proteína cinasa C (PKC) interactúa con el complejo WC y su actividad de cinasa se requiere para regular positivamente los niveles de expresión de *wc-1*. En *N. crassa* cuando se expresa una PKC constitutivamente activa, la expresión de *wc-1* se aumenta, pero si se expresa constitutivamente una PKC inactiva, se observa una disminución en los niveles de expresión de *wc-1* (Franchi *et al.*, 2005). Las alteraciones en los niveles de expresión de *wc-1* se ven directamente reflejados en la expresión de los genes regulados por la luz (Franchi *et al.*, 2005). Además, se ha considerado a la PKC como un participante importante en el mecanismo de foto-adaptación, debido a que un inhibidor que bloquea su actividad de cinasa, afecta la fosforilación de WC-1 y activación transcripcional de los genes regulados por la luz azul (Arpaia *et al.*, 1999).

2. Fotobiología de *Trichoderma/Hypocrea* spp

Los hongos filamentosos que pertenecen al género *Trichoderma/Hypocrea* forman parte de la clase Ascomycota. Varias especies de *Trichoderma/Hypocrea* crecen en los suelos como saprofitos sobre madera en descomposición o colonizando las raíces de las plantas. Aunque se ha descrito la fase sexual para algunas especies de *Trichoderma/Hypocrea*, su ciclo de vida es principalmente asexual, en el que se alternan las formas de micelio y de conidias. El micelio se caracteriza por poseer hifas más o menos ramificadas, tabicadas y con más de un núcleo por septo. Las conidias son esféricas de color verde, presentan un único núcleo haploide y se forman sobre estructuras denominadas conidióforos, que a su vez se sitúan sobre células denominadas fiálides (Rosen *et al.*, 1974). Se ha demostrado que diversas señales desencadenan la conidiación en *Trichoderma/Hypocrea*, entre ellas, la limitación de nutrientes, la desecación, el daño mecánico o cuando la colonia alcanza el final de la caja de Petri (Horwitz *et al.*, 1984; Carreras-Villaseñor *et al.*, 2012).

En 1951 Lilly y Barnett observaron que al inocular a *T. viride* en un medio rico en nutrientes y en completa oscuridad; *T. viride*, crece indefinidamente como micelio, sin embargo, al aplicar un pulso de luz azul, se induce la producción de conidias (fotoconidiación) en el perímetro de la colonia donde fue dado el estímulo luminoso (Figura 2). Esta observación permitió utilizar a *Trichoderma/Hypocrea* como modelo fotomorfogénico.



Figura 2. Efecto de la luz azul en la conidiación de *T. atroviride*. Conidias de *T. atroviride* se inocularon en el centro de una caja de Petri con medio PDA, y se incubaron a 28 °C en la oscuridad por 36 h. Posteriormente, las colonias resultantes se mantuvieron en la oscuridad como control **(A)** o se expusieron a un pulso de luz azul equivalente a 1200 $\mu\text{mol m}^{-2}$ **(B)**. Las colonias se incubaron en la oscuridad por 24 h y se registró su crecimiento.

El espectro de acción de la fotoconidiación es semejante al espectro de absorción de las flavinas y presenta la forma característica atribuida a los criptocromos, incluyendo un pico en la región cercana a la luz UV entre 350-380 nm, y un pico más alto en la región del azul con un máximo entre 440-450 nm (Gressel y Hartmann, 1968; Kumagai y Oda, 1969). Además, mediante experimentos hechos con roseoflavina, un análogo de la riboflavina, se concluyó que la flavina podría formar parte del fotorreceptor (Horwitz *et al.*, 1984).

Se ha observado que después de un pulso de luz azul hay cambios en la fosforilación de proteínas, en el potencial de membrana, en la actividad de la adenilato ciclasa (Horwitz *et al.*, 1985; Gresik *et al.*, 1988, 1999) y en el perfil transcripcional (Berrocal-Tito *et al.*, 1999; Rosales-Saavedra *et al.*, 2006). Se determinó que los genes *blr-1* y *-2* (blue light regulator -1 y -2) que codifican para el complejo fotorreceptor son los responsables de la respuesta a la luz azul (Casas-

Flores *et al.*, 2004). BLR-1 y BLR-2 son los ortólogos del complejo WC de *N. crassa* (Figura 3), y tienen un dominio de unión a ADN tipo GATA pero carecen de dominios de activación. Se ha propuesto la existencia de un tercer elemento que participaría como el activador (Casas-Flores *et al.*, 2004). La proteína BLR-1 presenta un dominio LOV y dos dominios PAS, mientras que BLR-2 solo contiene un dominio PAS. Las mutantes en los genes *blr-1* o *blr-2* afecta la conidiación y la transcripción de los genes responsivos a la luz. Dado que ambas mutantes tiene el mismo fenotipo, esto sugiere que BLR-1 y BLR-2 pudieran interactuar físicamente (Casas-Flores *et al.*, 2004, Rosales-Saavedra *et al.*, 2006). Dentro de los genes de respuesta luz en *T. atroviride*, se han encontrado dos clases: los que se inducen por la luz azul, denominados genes blu (blue light upregulated) y los que se reprimen por efecto de un pulso de luz azul, genes bld (blue light downregulated). Estos genes responsivos a la luz representan el 2.8% de los genes en este hongo (Rosales-Saavedra *et al.*, 2006). Se han identificado a la fecha 331 genes que son regulados por la luz blanca y 204 genes que son regulados por la luz azul (Carreras-Villaseñor *et al.*, 2012).

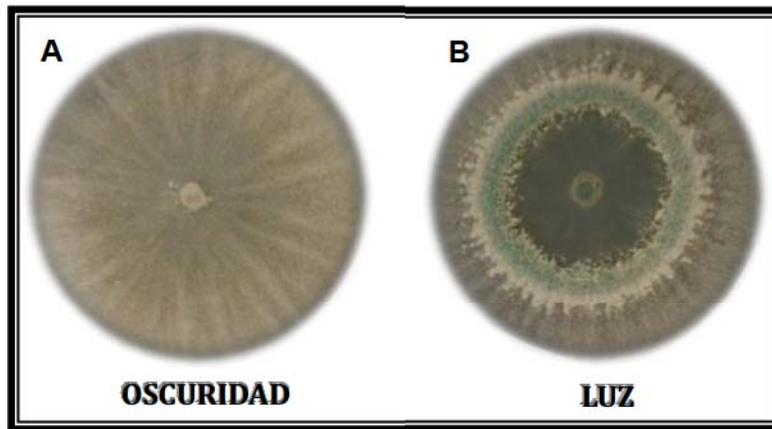
Además del complejo fotorreceptor BLR, en *Trichoderma* se ha descrito un segundo fotorreceptor denominado ENVOY (ENV1) (Schmoll *et al.*, 2004), ortólogo a VVD de *N. crassa*. En *T. atroviride* y *T. reesei* el transcrito del gen *env1* incrementa de 50 a 500 veces después de un pulso de luz azul y este aumento es dependiente de las proteínas BLR-1 y BLR-2 (Castellanos *et al.*, 2010; Herrera-Estrella *et al.*, datos sin publicar). Con base en el análisis de mutantes en *env1*, que en iluminación constante muestran una expresión sostenida de los genes responsivos a la luz, se propuso que ENV1 es el responsable de reprimir la expresión de los genes de respuesta a la luz (Castellanos *et al.*, 2010). ENV1 sería un regulador de la fotoadaptación en *Trichoderma*, de una manera similar a VVD en *N. crassa* (Schmoll *et al.*, 2005; Castellanos *et al.*, 2010).

En el grupo de genes inducidos por la luz azul, se encuentra el gen *phr-1* que codifica para la fotoliasa PHR-1. Esta enzima es la principal responsable de reparar

el daño en el DNA ocasionado por la luz UV, en un proceso conocido como fotorreactivación (Berrocal-Tito *et al.*, 2007). Un análisis por deleciones seriadas de 5' a 3' del promotor del gen *phr-1* identificó una secuencia denominada Región Responsiva a la Luz (LRR de sus siglas en inglés), que se requiere para la inducción por la luz. Los elementos identificados presentaron un arreglo semejante a los descritos para el gen *al-3* de *N. crassa*, pero con marcadas diferencias. La LRR contiene el consenso del núcleo LRE (Light Response Element) CGATB, pero no tiene un repetido directo como en *Neurospora*, sino que presenta varios repetidos de forma invertida (Cervantes-Badillo *et al.*, 2013). Además, se demostró que la proteína BLR-2 se encuentra en la oscuridad unida al LRR del promotor de *phr-1*, posiblemente para la activación inmediata de la transcripción en respuesta al estímulo luminoso (Cervantes-Badillo *et al.*, 2013).



Figura 3. Dominios de las proteínas WC y BLR. POLI-Q, regiones ricas en glutamina; LOV, dominio sensorial de unión al cromóforo FAD; PAS, dominio de interacción entre proteínas; CC, dominio "coiled-coil"; NLS, dominio de localización nuclear; GATA, dominio de unión a DNA.

2.1 Efecto de la luz, el AMPc y los nutrientes en *Trichoderma/Hypocrea*

En los hongos como en otros organismos, el crecimiento y el desarrollo se ven afectados por la calidad y la disponibilidad de las fuentes de carbono y las de nitrógeno. La luz tiene un papel muy importante en estos procesos. En *T. atroviride* se ha visto que las mutantes Δblr crecen más rápido que la cepa silvestre bajo condiciones de luz constante. También una mutante de *T. reesei* en el dominio PAS en ENV1 crece más lento que la cepa silvestre en luz constante (Castellanos *et al.*, 2010). (Casas-flores *et al.*, 2004). Esto indica la importancia de la percepción de la luz durante el crecimiento. Con respecto al efecto de los nutrientes en el crecimiento y la conidiación, un estudio demostró que en 17 de 95 fuentes de carbono analizadas, tales como D-manosa, D-galactosa, o hexosas, *Trichoderma* presentaba inducción del crecimiento bajo ciclos de luz/oscuridad o bajo luz constante, y que 48 de estas fuentes de carbono, incluyendo polioles y azúcares ácidos, indujeron la conidiación del hongo en condiciones de oscuridad (Friedl *et al.*, 2008a, b). Además las mutantes $\Delta blr-1$ y $\Delta blr-2$ fueron capaces de conidiar sólo en 17 fuentes de carbono. La presencia de AMP cíclico (AMPc) estimuló el crecimiento y la conidiación sólo en algunas de las 95 fuentes de carbono (Friedl *et al.*, 2008a).

2.2 Efecto de la luz en la síntesis de los peptaiboles y de los metabolitos secundarios.

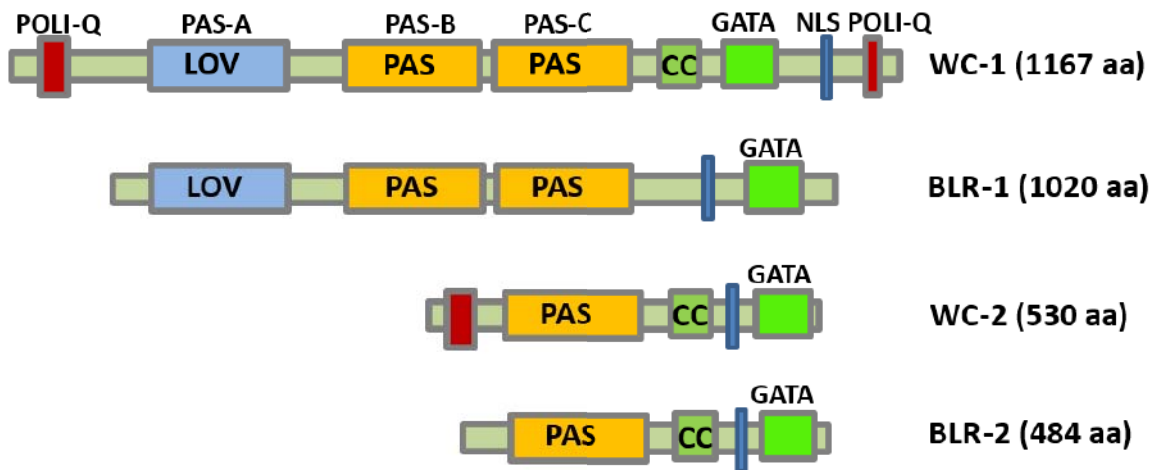
Los peptaiboles son una familia de péptidos pequeños (<20 aa) no ribosomales sintetizados por péptido sintetasas (NRPSs), los cuales presentan actividades antifúngicas y antibacterianas. En *Trichoderma/Hypocrea* la síntesis de peptaiboles se induce durante la conidiación. Además, la síntesis de peptaiboles se induce en presencia de un pulso de luz. Esta inducción se ve afectada en las mutantes $\Delta blr-1$ y $\Delta blr-2$ (Tomado de Casas-Flores y Herrera-Estrella, 2013).

La producción de metabolitos secundarios por acción de la luz se ha descrito en *T. virens*. Un pulso de luz induce la transcripción del gen *veA*, y mutantes en este gen

muestran una alteración en la inducción de genes que codifican para enzimas que participan en el metabolismo secundario (Mukherjee y Kenerley, 2010).

2.3 Participación de la proteína cinasa A (PKA) en respuesta a luz azul

En *T. atroviride* la PKA tiene un impacto directo sobre la fotoconidiación y la expresión de los genes regulados por la luz azul a través de las proteínas BLR (Casas-Flores *et al.*, 2006). Cepas de *T. atroviride* con baja actividad de PKA, producen conidias de manera constitutiva y están alteradas en la activación de los genes regulados por la luz azul. En cambio, cepas de *T. atroviride* con alta actividad de PKA responden a la luz azul mediante la activación de los genes a través de las proteínas BLR, pero son incapaces de conidiar (Casas-Flores *et al.*, 2006). Estos resultados indican que la actividad de PKA es necesaria para la activación de los genes regulados por la luz azul a través del complejo BLR (Casas-Flores *et al.*, 2006).

2.4 La luz azul y las proteínas G heterotriméricas

En los hongos las proteínas G regulan la morfogénesis, el apareamiento, el crecimiento y la división celular, el metabolismo secundario y la virulencia (Li *et al.*, 2007). En *T. atroviride* la sobreexpresión de $G\alpha$ (con una alta similitud a genes $G\alpha i$ que codifican para proteínas inhibitorias de $G\alpha$) inhibe la conidiación en respuesta a la luz. Cepas que contienen una copia del gen silvestre *tga-1* (*T. atroviride* G-protein alpha-subunit *gene*) y al menos una copia del alelo mutado (QL-1) muestran este fenotipo. En *T. reesei* el ortólogo a *tga-1* denominado *gna3*, se expresa a bajos niveles en la oscuridad, mientras que un pulso de luz azul induce su expresión (Schmoll *et al.*, 2009).

3. Estructura de la cromatina

En las células eucariotas el ADN se encuentra organizado en una estructura nucleoproteica denominada cromatina. La unidad fundamental de esta estructura es el nucleosoma, una estructura de aproximadamente 10 nm de diámetro compuesta por un octámero de histonas que incluyen dos moléculas de cada una de las histonas H2A, H2B, H3 y H4, y de aproximadamente 160 pb de ADN enrollando al octámero. En un contexto heterocromático, usualmente no se lleva a cabo la transcripción (Struhul *et al.*, 1999), ya que la cromatina compacta funge como una barrera que impide el acceso o el paso de la maquinaria transcripcional al ADN. Sin embargo, se sabe que la cromatina está sujeta a modificaciones covalentes cuyo blanco son principalmente las histonas. Las modificaciones en las histonas se llevan a cabo principalmente en los dominios amino terminal. Estas modificaciones pueden inducir un estado abierto o cerrado de la cromatina, lo que repercute en un incremento o una disminución en la accesibilidad al ADN por los complejos transcripcionales (Strahl y Allis., 2000; Jenuwein y Allis, 2001). Entre las modificaciones a las cuales están sujetas las histonas, se incluye a la fosforilación, la ubiquitinación, la acetilación, la ADP ribosilación y la metilación. Las proteínas que llevan a cabo estas modificaciones se conocen como co-activadores o co-represores (Washburn y Esposito, 2001). Debido a que estas modificaciones afectan el estado transcripcional, se ha propuesto que existe un “código de histonas” (Jenuwein y Allis, 2001). El ADN también es susceptible de modificaciones tales como la metilación, y afecta también el estado transcripcional. Al conjunto de modificaciones en las histonas y en el ADN, que afectan el perfil transcripcional de ciertos genes, y al hecho de que se pueden mantener dentro de la población y heredarse, se le denomina epigenética.

4. Acetilación de las histonas

Una de las modificaciones de las histonas más estudiadas es la acetilación de los residuos conservados de lisinas en los dominios amino terminal. La acetilación de las histonas, se lleva a cabo por las acetil transferasas de histonas (HAT por sus

siglas en inglés), y se ha postulado que el efecto de la acetilación lleva a la neutralización parcial de las cargas positivas de las histonas, lo que hace que se debilite la afinidad por el ADN (Workman *et al.*, 1998). Este proceso permite relacionar la acetilación de histonas con la cromatina transcripcionalmente activa, por lo que se clasifica a las HATs como coactivadores de la transcripción (Figura 4). Las HATs se clasifican en dos grupos: Las de tipo A localizadas en el núcleo (Brownell *et al.*, 1996) y las de tipo B que se encuentran en el citoplasma, estas últimas participan en la acetilación de las histonas libres que han sido recién sintetizadas en el citoplasma para su transporte al núcleo donde pueden ser desacetiladas e incorporadas a la cromatina (Ruiz-Carrillo *et al.*, 1975; Allis *et al.*, 1985).



Figura 4. Modelo de la activación de genes mediante la acetilación de las histonas. La acetilación de histonas conlleva a la formación de una estructura “abierta” de la cromatina que permite a los factores remodeladores de la cromatina dependientes de ATP, así como a los factores transcripcionales acceder a los promotores. Los nucleosomas se muestran en color azul turquesa, el coactivador HAT se muestra en naranja. Las estrellas de color rojo señalan los residuos blancos de acetilación en las histonas (Tomado y modificado de Ito *et al.*, 2007)

4.1 La proteína Gcn5p, su actividad como acetil transferasa de histonas y su papel como coactivador

La p55 del protozoario ciliado *Tetrahymena thermophila* fue la primer proteína identificada con actividad de HAT de tipo A (Brownell *et al.*, 1996). Se descubrió en preparaciones macronucleares en un ensayo de actividad en gel, que reveló que un polipéptido de 55 kDa (p55) presentaba actividad de acetilación en histonas libres (Brownell y Allis, 1995). La p55 es una proteína ortóloga a Gcn5 (General control nonderepressible-5) de *Saccharomyces cerevisiae* (Georgakopoulos y Tiresos, 1992), la cual se describió como un regulador transcripcional (Berger *et al.*, 1992; Marcus *et al.*, 1994; Silverman *et al.*, 1994). Este descubrimiento demostró la relación que existe entre la regulación transcripcional y la acetilación de las histonas. Además, *GCN5* está altamente conservado en eucariotas ya que se encuentra presente en diversos organismos, incluyendo al humano (Candau *et al.*, 1996), al ratón (Xu *et al.*, 1998), a *Drosophila melanogaster* (Smith *et al.*, 1998), y a *Toxoplasma gondii* (Hettmann *et al.*, 1999).

5. Estudios sobre la modificación covalente de las histonas inducidas por la luz azul

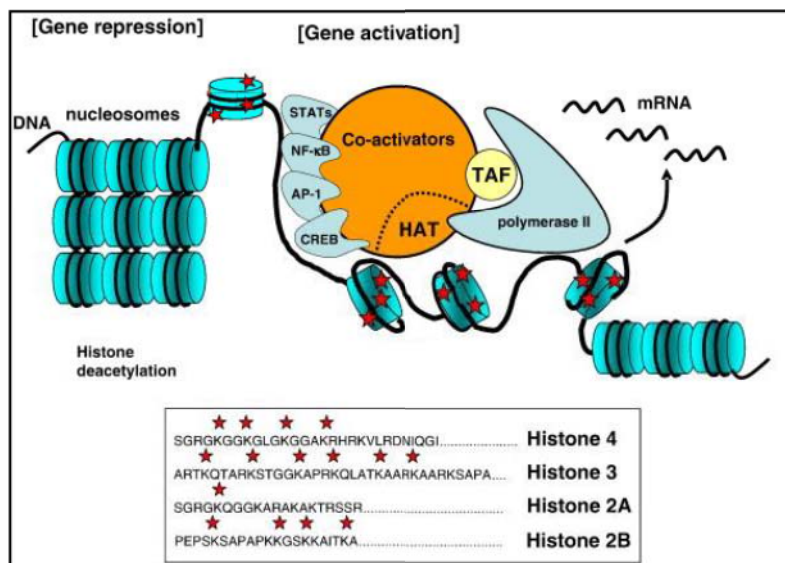
En *N. crassa* la activación transcripcional del gen *al-3* es dependiente de la luz, y está relacionada directamente con una acetilación transitoria de la lisina 14 de la histona H3 localizada sobre el promotor (Grimaldi *et al.*, 2006). Esta modificación la realiza la acetil transferasa de histonas NGF-1, ortólogo de Gcn5p de *S. cerevisiae*. Recientemente se demostró que NGF-1 y el fotorreceptor WC-1 interaccionan físicamente, lo cual es necesario para llevar a cabo la transducción de la señal luminosa en *N. crassa* (Brenna *et al.*, 2012). En *Arabidopsis thaliana* la HAT, TAF1, es necesaria para la regulación del alargamiento del hipocotilo (etiología) y la expresión de genes mediado por la luz (Bertrand *et al.*, 2005). En *Mus musculus* se determinó que la inducción por la luz de genes implicados en el ritmo circadiano (*mPer1* y *mPer2*), está relacionada con la acetilación de las histonas H3 y H4 localizadas en sus promotores, y que además es rítmica (Naruse *et al.*, 2004). Estos

ejemplos muestran la relevancia que tienen los procesos epigenéticos en el control de genes inducidos por la luz.

JUSTIFICACIÓN

En la actualidad, se han realizado muchos esfuerzos por entender a profundidad el fenómeno de la percepción de la luz en *T. atroviride*. Existen una buena cantidad de estudios fotobiológicos, bioquímicos y más recientemente estudios genéticos/moleculares que han ayudado a comprender los diferentes procesos fisiológicos y del desarrollo en respuesta a la luz azul. Sin embargo, se desconocen los mecanismos moleculares que regulan la actividad transcripcional en el contexto de la cromatina.

En el presente trabajo queremos determinar la relación que existe entre la percepción de la señal luminosa y los mecanismos epigenéticos que controlan la respuesta a la luz azul en *Trichoderma*. Esto permitirá comprender este fenómeno en los hongos, y en la mayoría de los organismos.

OBJETIVO GENERAL:

Estudiar la relevancia de la acetilación de las histonas en la regulación de los genes de la respuesta a luz azul en *T. atroviride*.

Objetivos particulares:

- 1) Determinar los patrones de acetilación global en respuesta a la luz azul en *Trichoderma atroviride*.
- 2) Identificar y clonar el gen que codifica para la proteína ortóloga a Gcn5p de *S. cerevisiae* en *T. atroviride*.
- 3) Interrumpir el gen *tgf-1* en *T. atroviride*.
- 4) Analizar el fenotipo de la mutante $\Delta tgf-1$ en respuesta a la luz azul
- 5) Determinar los patrones de acetilación de histonas sobre el promotor del gen *phr-1* en respuesta a luz azul.

RESULTADOS PARTE I

La expresión de los genes *phr-1* y *bld-2* se altera por la adición de Trichostatina A, un inhibidor de desacetilasas de histonas

Para entender el efecto de la acetilación de histonas en las respuestas a luz azul en *T. atroviride*, analizamos el efecto del inhibidor de desacetilasas de histonas (HDACs), Tricostatina A (TSA) en la expresión de los genes *phr-1* y *bld-2*. Colonias de la cepa silvestre de *T. atroviride* crecidas en la oscuridad por 36, se trataron durante 6 h con TSA (300 ng/ml), para posteriormente someterla a un pulso de luz azul. En la cepa silvestre, la transcripción de *phr-1* alcanzó un nivel máximo a los 30 min después de que se aplicó el pulso de luz azul, y su expresión decayó a los 120 min, como se describió previamente (Berrocal-Tito *et al.*, 1999). Por otro lado, el gen *bld-2* mostró niveles de expresión elevados en la oscuridad y se reprimió por acción de la luz azul como se ha descrito (Rosales-Saavedra *et al.*, 2006). La adición de TSA al medio de cultivo, indujo una marcada reducción en el nivel de la transcripción de los genes *phr-1* y *bld-2* en comparación con la cepa sin tratar con TSA (Figura 5). Este resultado sugiere que la regulación de genes responsivos a la luz azul está mediada por procesos de acetilación y desacetilación de las histonas.



Figura 5. Efecto del tratamiento con TSA en la transcripción de los genes *phr-1* y *bld-2* en *T. atroviride*. La cepa silvestre se cultivó en la oscuridad durante 36 h, y posteriormente, el micelio se trató con TSA (300 nM) por 6 horas (barras grises), se aplicó un pulso de luz azul (1,200 $\mu\text{mol m}^{-2}$) y se colectaron los micelios a los tiempos indicados. Se extrajo el RNA total y se sometió a un análisis de qRT-PCR. La cepa silvestre crecida en ausencia de TSA se incluyó como control (barras negras). Los datos se normalizaron mediante el método de $2^{\Delta\Delta\text{CT}}$ con la expresión del gen control *tef-1*. Las gráficas muestran los niveles de desviación estándar \pm SD, derivadas de 2 experimentos.

El inhibidor específico de la proteína *GCN5* de *S. cerevisiae*, MC1626, inhibió la fotoconidiación y alteró el patrón de expresión de los genes responsivos a la luz en *T. atroviride*.

Una vez obtenidos los datos sobre el efecto del TSA y el posible papel de las HDACs en la transcripción de genes responsivos a la luz, nos preguntamos si el gen ortólogo a *GCN5* de *S. cerevisiae* participa en la regulación de la percepción de la señal luminosa en *T. atroviride*. La cepa silvestre se creció en medio PDA en ausencia (-MC1626) o presencia de 0.2 μM de MC1626, un inhibidor específico de Gcn5 de *S. cerevisiae* (Chimenti *et al.*, 2009). A las 36 horas se aplicó un pulso de luz azul. De

forma interesante, *Trichoderma* fue incapaz de conidiar en respuesta a la luz en presencia del compuesto MC1626 (Figura 6).

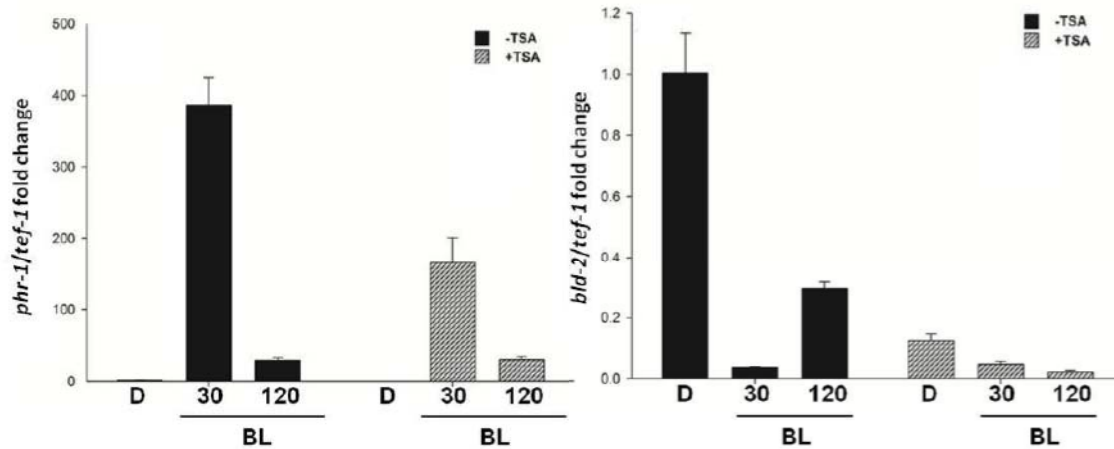

Figura 6. Efecto del inhibidor de Gcn5, MC1626, en la fotoconidiación de *T. atroviride*. Las imágenes muestran las colonias crecidas a 28°C en la oscuridad por 36 h en ausencia o presencia de 0.2 μM del inhibidor MC1626. Posteriormente se expusieron a un pulso de luz azul equivalente a 1200 μmoles y fotografiadas 48 horas después.

El inhibidor MC1626 afecta negativamente el crecimiento en *T. atroviride*.

Debido a que se ha observado que las cepas de *S. cerevisiae* que carecen del gen *GCN5* (ΔGCN5) muestran un crecimiento muy lento (Howe *et al.*, 2001), nos preguntamos si un incremento en la concentración del inhibidor MC1626, podría presentar un efecto negativo sobre crecimiento de *T. atroviride*. La presencia de 1mM de MC1626 en el medio de cultivo (una concentración 500 veces mayor a la utilizada para los ensayos de fotoconidiación) provocó una marcada reducción en el crecimiento, comparada con la condición control. Las condiciones de crecimiento, también inhibieron la fotoconidiación en el hongo (Figura 7). Estos resultados sugieren que posiblemente la HAT homóloga a Gcn5p de *S. cerevisiae* juega un

papel importante en el desarrollo y la conidiación inducida por luz azul en *T. atroviride*.

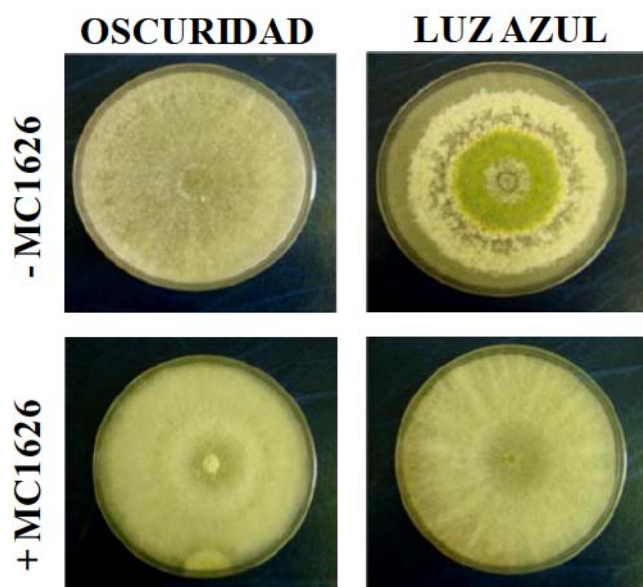

Figura 7. Efecto del MC1626 en el crecimiento de *T. atroviride*. La cepa silvestre se creció a 28°C en ausencia o presencia (+MC1626) de 1mM de MC1626 durante 5 días con ciclos de 12h luz/oscuridad, y fotografiadas.

Con la finalidad de investigar el efecto del inhibidor MC1626 sobre la expresión de los genes *phr-1* y *bld-2*, se creció a la cepa silvestre en presencia o ausencia del compuesto, se aplicó un pulso de luz y se extrajo el RNA total para medir la actividad transcripcional de los genes. La cinética de expresión de los genes no se modificó en presencia del compuesto MC1626 comparado con la muestra control, sin embargo tanto el gen *bld-2* como el gen *phr-1* mostraron diferencias perceptibles en la cantidad de sus transcritos (Figura 8).

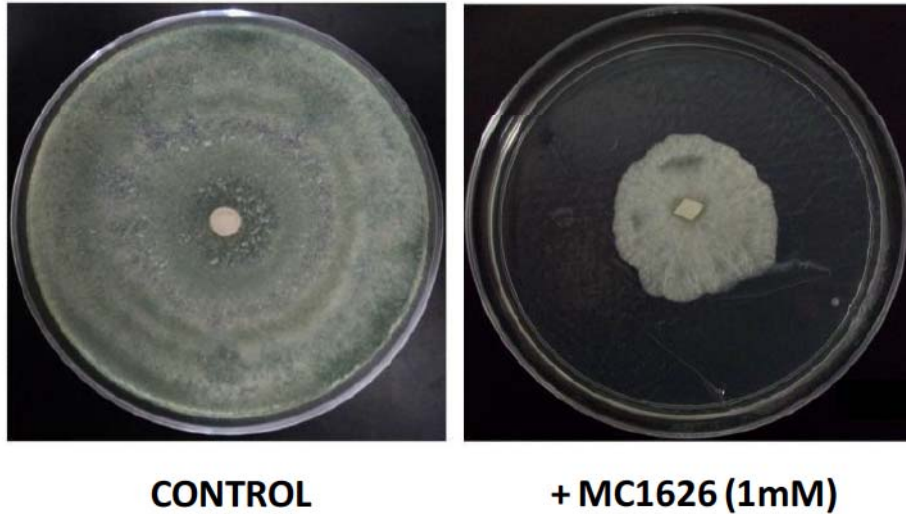

Figura 8. Efecto del inhibidor MC1626 en la transcripción de genes responsivos a la luz en *T. atroviride*. La cepa silvestre se creció en ausencia (A) o presencia de 0.2 μ M de MC1626 (B), y el RNA total de los micelios se extrajo después de un pulso de luz azul a los tiempos indicados (min). La expresión de los genes *phr-1* y *bld-2* se analizó por RT-PCR punto final con oligonucleótidos específicos. OSC: oscuridad. El gen *act-1* se utilizó como control de carga.

RESULTADOS PARTE II

The histone acetyltransferase TGF-1 is the coactivator of blue light-induced genes in *Trichoderma atroviride*

Edith Elena Uresti-Rivera, Mayte Guadalupe Cervantes-Badillo, Tania Muñoz-Centeno, Elida Yazmin Gómez-Rodríguez, Sergio Casas-Flores*

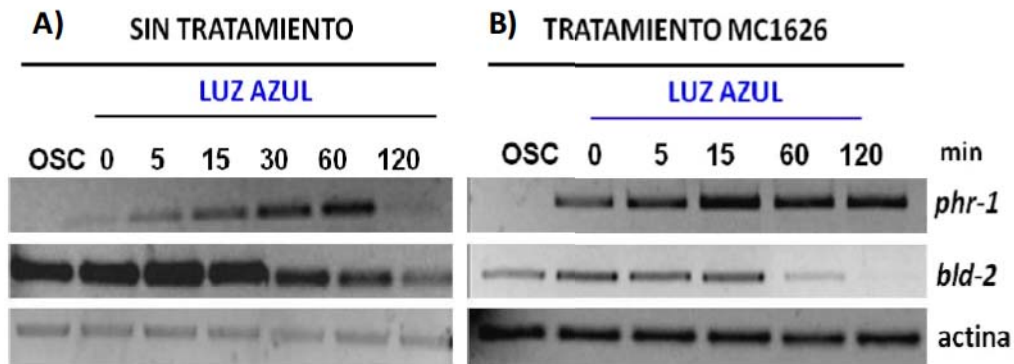
IPICYT, División de Biología Molecular. Camino a la presa San José No. 2055, Colonia Lomas 4a sección. C.P. 78216. San Luis Potosí, Mexico.

***Correspondence**

S. Casas-Flores

IPICYT, División de Biología Molecular. Camino a la presa San José No. 2055, Colonia Lomas 4a sección. C.P. 78216. San Luis Potosí, Mexico.

Phone: +52 (444) 8342046; Fax: +52 (444) 8342010;

E-mail: scasas@ipicyt.edu.mx

Running title: The TGF-1 acetyltransferase regulates light responsive genes

Abstract

In the filamentous fungus *Neurospora crassa*, the White Collar (WC)-1 and -2 proteins regulate all known responses to blue light. The WC-1 protein is the photoreceptor and together with WC-2 function as transcription factors of blue light inducible genes. In *N. crassa*, the histone acetyltransferase NGF-1 is the co-activator of blue light induced genes, and physically interacts with WC-1 to regulate the blue light response. In *Trichoderma atroviride*, the BLR-1 and BLR-2 proteins are the orthologues of WC-1 and WC-2, and they regulate also the light responses. BLR-1 has been proposed as a blue light receptor. Here we show that blue light induces a global acetylation of histone H3. Deletion of *tgf-1*, which encodes for a putative histone acetyltransferase, led to a pleiotropic phenotype affecting mainly growth and development. Transcription and Chromatin immunoprecipitation (ChIP) analysis showed that TGF-1 is the coactivator of blue light regulated genes, probably by acetylating lysine K9 and K14 of histone H3 on their promoters. Furthermore, we demonstrate that in the darkness, TGF-1 is necessary to maintain the basal levels of the blue light down regulated gene, *bld-2*. TGF-1 is essential

for histone H3 acetylation on the promoters of the *phr-1* and *bld-2* genes after a blue light pulse and in darkness, respectively.

Introduction

Sunlight is one of the most important environmental cues for living organisms and fungi are no exception. Fungi are able to detect the light in a wide range of wave lengths of the solar spectrum, from UV to far-red. Fungi sense light through chromophore-protein complexes named photoreceptors (Froehlich et al., 2002; Cheng *et al.*, 2004; Ko *et al.*, 2007). In fungi, light regulates several physiological and developmental processes, including synthesis of pigments and secondary metabolism, sexual and asexual development, circadian rhythms, and phototropism (Kritskii *et al.*, 2005; Purschwitz *et al.*, 2006; Herrera-Estrella y Horwitz, 2007; Chen *et al.*, 2009; Rodríguez-Romero *et al.*, 2010). For several decades, the filamentous fungus *Neurospora crassa* has been used as model to study light responses in eukaryotic organisms (Dunlap and Loros, 2004; Heintzen and Liu, 2007). In *N. crassa*, all known responses to blue are regulated by the GATA transcription factors WHITE COLLAR-1 (WC-1) and WHITE COLLAR -2 (WC-2) (Ballario *et al.*, 1996; Crosthwaite *et al.*, 1997; Linden *et al.*, 1997). WC-1 is the blue light receptor, which contains two PER-ARNT-SIM (PAS) domains for protein-protein interactions, and a specialized LOV (Light, Oxygen, and Voltage) domain that sense light (Ballario and Macino 1997; Crosthwaite *et al.*, 1997; Cheng *et al.*, 2003), and WC-2 has only one PAS domain (Linden y Macino, 1997), with which it interacts with WC-1 to form the White Collar Complex (WCC) *in vivo* to activate the transcription of light inducible genes (Linden *et al.*, 1997; Cheng *et al.*, 2002; Liu *et al.*, 2003). A hierarchical light-signaling network after a blue light pulse was described recently (Chen *et al.*, 2009). The WCC binds to early light response elements (ELRE) to drive the transcription of early light responsive genes (ELRG), with maximal expression observed between 15-30 min after the light stimulus (Linden *et al.*, 1997). SUB-1 is a transcription factor that drives late-light responsive genes (LLEG) that show their maximal expression between 45 to 120 min after the light stimulus (Linden *et al.*, 1997; Chen *et al.*, 2009).

In *N. crassa*, blue light-induced transcription is accompanied by epigenetic modifications. Histone acetylation and deacetylation are key modifications which control chromatin structure; thus regulating positively and negatively gene transcription. Histone acetyltransferases (HATs) and histone deacetylases (HDACs) are the enzymes responsible for maintaining homeostatic balance of histone acetylation in the cell (Lee and Workman, 2007; Grunstein, 1997; Hassig *et al.*, 1998; Kadosh and Struhl, 1998). HDACs and HATs are considered co-repressors and co-activators. HDACs catalyze the removal of acetyl groups from lysine residues from N-termini of histones, whereas HATs transfer acetyl groups from Acetyl-CoA to lysine residues in the N-termini of histones. Gcn5p from *Saccharomyces cerevisiae* is the founding member of GNAT (GCN5-related N-acetyltransferase) family of HATs and is likely to be present in all eukaryotes. Gcn5p acetylates preferentially lysine 9 and 14 from histone H3, and lysine 8 and 16 of histone H4 (Georgakopoulos and Thireos, 1992; Dyda *et al.*, 2000; Kuo *et al.*, 1996; Saleh *et al.*, 1997; Grant *et al.*, 1997; Sendra *et al.*, 2000).

There is little evidence regarding the role of histone acetylation in gene expression induced by light. It has been shown in *N. crassa* that a transiently light induced acetylation of lysine 14 of histone H3 on the promoter of *al-3* gene is essential for its induction, and that the WC-1 protein plays a pivotal role in this process (Grimaldi *et al.*, 2006). In addition, the NGF-1 protein, the orthologue of Gcn5p is responsible for this light induced acetylation, since a mutant in *ngf-1* was defective in photoinduction (Grimaldi *et al.*, 2006). Recently, it was shown that WC-1, a vertebrate nuclear receptor orthologue, physically interacts with NGF-1 as a preassembled complex in the dark on the *al-3* promoter, and a light pulse leads to NGF-1 to acetylate H3 enabling transcriptional activation (Brenna *et al.*, 2012).

During the last two decades, members of the *Trichoderma/Hypocrea* genera have become molecular photomorphogenic models since exposure to a brief pulse of light causes morphological, biochemical and molecular changes in these fungi. These changes include the appearance of a ring of green conidia at the edge of an actively growing colony, an increase in the adenylyl cyclase activity and in cAMP levels, protein phosphorylation and transcriptional regulation of genes (Horwitz *et al.*, 1984; Gresik *et al.*, 1988, 1999; Berrocal-Tito *et al.*, 1999; Rosales-Saavedra *et al.*, 2006, Carreras-Villaseñor *et al.*, 2012).

The BLR-1 and BLR-2 proteins of *Trichoderma* are the *N. crassa* homologs of WC-1 and WC-2, (Casas-Flores *et al.*, 2004). Mutants in either *blr-1* or *blr-2* genes are defective in conidiation and transcription regulation of blue light responsive genes (Casas 2004 y Rosales 2006). The *blr* mutants are also affected in sulfur, carbon metabolism, synthesis of cellulase, sexual development, and vegetative growth, as well as in response to oxidative stress and synthesis of peptaibols (Casas-Flores *et al.*, 2004; Casas-Flores *et al.*, 2006; Friedl *et al.*, 2008a,b; Komon-Zelazowska *et al.*, 2007; Chen *et al* 2010; Seibel *et al.*, 2012). Several lines of evidences have shown the active role of MAP-kinase, cAMP-dependent protein kinase, and heterotrimeric G-proteins in such processes (Casas-Flores and Herrera-Estrella, 2013). Microarray analysis of *T. atroviride* showed 30 blue-light upregulated genes (*blu*), whereas 10 genes were down regulated (*bld*) (Rosales-Saavedra *et al.*, 2006). Massive gene expression analysis of *T. atroviride* in response to light showed that approximately 331 genes were expressed by both blue light and white light (Carreras-Villaseñor *et al.*, 2012). Furthermore, the overexpression of BLR-1 led to downregulation of *blu* genes, whereas the overexpression of BLR-2 increased transcription of such genes (Esquivel-Naranjo and Herrera-Estrella, 2007). Blue light responsive genes include the well-characterized *phr-1* gene, which encodes photolyase, an enzyme responsible to repair DNA damage induced by UV-light (Berrocal-Tito *et al.*, 1999; Berrocal-Tito *et al.*, 2007). Deletion of *phr-1* led to defects in DNA repair and to a down regulation of blue light responsive genes. Conversely, the overexpression of *phr-1* led to the upregulation of *blu* genes, including its own transcript, indicating that PHR-1 regulates its own transcription in a positive feedback loop (Berrocal-Tito *et al.*, 2007). However, there are few studies on the epigenetics of blue light perception in the genus *Trichoderma*/*Hypocrea* are null.

Here we show the role of the histone acetyltransferase TGF-1 in *T. atroviride* regarding growth and development, as well as in the regulation of blue light responses. Chromatin immunoprecipitation assays showed the role of TGF-1 in acetylating histone H3.

MATERIALS AND METHODS

Trichoderma strains, media and growth conditions

Trichoderma atroviride wild-type strain IMI 206040 (ATCC 32173) and the $\Delta tgf-1$ mutant (this work) were routinely grown on Potato Dextrose Agar (PDA) (Difco). PDYCB (per liter: 24 g potato dextrose broth, 2 g yeast extract and 1.2 g casein hydrolysate medium) was used for Trichostatine A (TSA) (Sigma, St Louis, MO USA) experiments and for growth of mycelia used in protoplast transformation. PDB containing 0.8% agarose, 0.5 M sucrose, and 200 μg hygromycin B ml^{-1} was used for protoplast regeneration. *Escherichia coli* strain TOP10F' (Invitrogen, Carlsbad, CA USA) was used for plasmid DNA transformation.

Photoinduction assays

Conidia from the *T. atroviride* wild type strain were inoculated in the center of a PDA plate, grown at 25 °C during 48 h in total darkness, and used as pre-inoculum. Pre-inoculum was used to inoculate mycelial plugs in the center of PDA plates overlaid with an sterile cellophane sheet and further incubated at 25 °C for 36 h in total darkness. Mycelium from the $\Delta tgf-1$ strain was inoculated in PDB, grown at 25 °C in a rotator shaker at 200 rpm by 72 h, and used as pre-inoculum. The $\Delta tgf-1$ pre-inoculum was poured on PDA plates overlay with a sterile cellophane sheet, and allowed to grow for further 36 h in the dark. Photoinduction of cultures were carried out as previously described (Berrocal-Tito *et al.*, 1999). For TSA assays with the wild type strain, pre-inoculum was obtained as described above. Thereafter, mycelial plugs were inoculated on Petri dishes containing a sterile cellophane sheet overlaying a double layer of filter paper (an 8 cm disk of Whatman 50 was overlaid on a 7 cm disk of Whatman 1 filter paper) soaked in 3 mL of PDYCB medium. Cultures were grown for 36 h at 25 °C in total darkness. Then, the cellophane sheets containing the wild type growing colonies were placed in a new plate with double layer of filter paper as described above, but containing fresh PDYCB medium with or without 300 ng/mL TSA, and were allowed to growth for additional 6 h. Briefly, the cultures were photoinduced as described elsewhere (Berrocal-Tito *et al.*, 1999). Mycelia were collected

30 and 120 min after a blue light pulse under low red safe light (LEE filter #106, fluence rate $0.1 \text{ mmol m}^{-2} \text{ s}^{-1}$) and immediately frozen in liquid nitrogen for total RNA extraction. Mycelia growing in the dark were included as non-light induced control.

Generation of the $\Delta tgf-1$ mutant by gene replacement

The plasmids used was pBHY70, which harbors the hygromycin phosphotransferase gene under the control of the *Aspergillus nidulans trpC* promoter (Carrol *et al.*, 1994) in the *Eco*RV restriction site (Casas-Flores *et al.*, 2004). The complete *tgf-1* coding sequence was entirely replaced by the hygromycin B resistance cassette (*hph*), through homologous recombination. The *tgf-1* gene replacement construct was generated by amplifying a 2.3 kb fragment located upstream of *tgf-1* gene with the $\Delta tgf5'$ -F and $\Delta tgf5'$ -R oligonucleotides containing the *Kpn* I and *Hind* III restriction enzymes sites at the 5' end respectively (Table 1). Subsequently, this amplicon was cloned in their corresponding restriction sites of the pBHY70. Thereafter, a 1.0 kb fragment located downstream of the *tgf-1* gene was PCR amplified by using the $\Delta tgf3'$ -F and $\Delta tgf3'$ -R oligonucleotides containing the *Pst* I and *Xba* I restriction enzymes sites at their 5' end respectively (Table 1). Then, the amplicon was cloned into their corresponding restriction sites of the pBHY70 plasmid, resulting the p $\Delta tgf-1$ deletion construct. This construct was PCR amplified and used for PEG-mediated protoplast transformation as previously described (Baek & Kenerley, 1998). For the screening of gene-replacement events, DNA from the hygromycin-resistant colonies was subjected to qPCR to confirm the absence of the *tgf-1* gene, in addition to detect ectopic insertions of *hph* cassette in the *T. atroviride* genome, using specific primers for both genes (Table 2). The copy number of *hph* and *tgf-1* in the genome of the transformants was calculated by quantitative PCR, using the $2^{-\Delta\Delta C_t}$ method (Bubner and Baldwin, 2004). DNA from the $\Delta blr-1$ strain was used as a calibrator, since Southern analysis has shown that it harbors one copy of the *hph* gene (Casas-Flores *et al.*, 2004).

RNA isolation and quantitative RT-PCR

Total RNA of the wild type and $\Delta tgf-1$ strains was isolated using Trizol® (Invitrogen) reagent following the manufacturer's protocol. 5µg of total RNA were DNase I (RNase-

free) (Ambion, Austin, TX USA) treated at 37°C for 1 h, and then reverse-transcribed with SuperScript II Reverse Transcriptase (Invitrogen, Carlsbad, CA, USA), following the manufacturer's recommendations. The PCR reaction was performed with 100 ng of cDNA in a 7500 Real-Time PCR system (Applied Biosystems, Foster City, CA USA), using the kit Fast Syber Green Master Mix (Applied Biosystems). Two experiments were independently carried out and each reaction was performed in triplicate. The $2^{-\Delta\Delta CT}$ method was used to obtain the relative expression of each specific gene.

Protein immunoblot

T. atroviride wild-type was grown as described above for blue light induction experiments. Photoinduced mycelia from different times were used for total protein extraction as described (Sambrook *et al.*, 1989). Protein immunoblots were carried out as described elsewhere (Amersham Hybond-N, GE Healthcare, UK). Antiserums used were: unmodified histone H3 (Abcam, MA. USA), acetylated H3 (06 –599; Upstate Biotechnology) and Gcn5p (sc-9078; Santa Cruz, CA. USA).

Chromatin immunoprecipitation (ChIP) assays

ChIP assays were performed as previously described (Grimaldi *et al.*, 2006) with some modifications. Photoinduction assays were performed as described above, and approximately 200 mg of mycelia were crosslinked for 1 h in 10 ml of cross-linking buffer (50mM HEPES pH 7.4; 137mM KCl; 1mM EDTA) containing 1% formaldehyde and then neutralized with Glycine 0.125 M for 5 min. Cross-linked chromatin–protein complexes were immunoprecipitated with antibodies against unmodified histone H3 (Abcam, MA. USA), acetylated H3 (06 –599; Upstate Biotechnology, NY. USA) and Gcn5p (sc-9078; Santa Cruz, CA. USA). Immunoprecipitated chromatin samples were analyzed by qPCR for specific promoter regions (LRR) of blue-light regulated (*phr-1* and *bld-2*) and constitutive genes (*tef-1*) (Table 1) of *T. atroviride* and normalized using the $2^{-\Delta\Delta Ct}$ method, against the % of INPUT DNA (Livak KJ and Schmittgen TD, 2001).

RESULTS

Blue light induces an increase in histone H3 global acetylation and it was further increased by the addition of TSA

It is well known that light regulates gene transcription in fungi. However, there are very few studies addressing the influence of epigenetic mechanisms on gene transcription induced by light. To explore whether blue light influences epigenetic changes in *T. atroviride*, the acetylation of histone H3, one of the more studied epigenetic marks, was examined. To do this, we first tested our system measuring the expression levels of the photoregulated gene *phr-1* by qRT-PCR (Figure 1A). As expected, transcription levels of *phr-1* transcript were low in the dark (basal level), while a brief pulse of blue light induces its transcription, showing a maximum peak at 30 min, and decaying at almost its basal levels 120 min after the light pulse (Figure 1A). We determined the effect of blue light on the acetylation of histone H3 (H3-Ac) by using antibodies against histone H3 (H3) and acetylated histone H3 (H3-Ac) to immunoprecipitate total protein extracts from mycelia from the wild-type strain exposed to blue light (Figure 1B). Western blot analysis revealed slightly but significantly increased levels of H3-Ac after 30 min of the blue light stimulus as compared to a control grown in darkness, whereas after 120 min H3-Ac decreased to almost the same levels of mycelia grown in the dark (figure 1B). Addition of the histone deacetylase-inhibitor, TSA to the culture media enhanced H3-Ac in all tested conditions, maintaining a similar pattern to the untreated mycelia (Figure 1C). Together these results suggest the participation of epigenetic mechanisms on blue light transcriptional regulation in *T. atroviride*.

Deletion of *tgf-1* gene in *Trichoderma atroviride*

To investigate more closely the involvement of epigenetic mechanisms on blue light regulation of transcription in *T. atroviride*, we identified the *GCN5* orthologue in the *T. atroviride* genome (<http://genome.igi-psf.org/Triat2/Triat2.home.html>), which encodes for the *T. atroviride* histone acetyltransferase TGF-1 (*T*richoderma *G*CN *F*ive). The nucleotide sequence of *T. atroviride* *tgf-1* gene (protein ID 47901 and GeneBank, EHK39839.1) is 1336 bp in length, it contains two introns and encodes for a 402 amino acids protein.

Sequence analysis of TGF-1 protein showed that it has a 59% and 85% amino acid identity with Gcn5p and NGF-1, respectively (Figure 1). The TGF-1 predicted structure showed the presence of a catalytic acetylation domain and a bromodomain similar to those contained in Gcn5p and NGF-1 HATs. The TGF-1 acetylation domain is 77.8% identical to Gcn5p, and 100% to NGF-1. On the other hand, the TGF-1 bromodomain presents a 63.1% identity with Gcn5p, and 86.9 % with NGF-1 (Figure 2). We designed oligonucleotide to amplify both (Table 1) *tgf-1* ORF flanking sequences and clone them in the pBHY70 plasmid to generate a gene replacement construct (see material and methods for details). The p Δ *tgf-1* construct was PCR amplified with specific primers (Table 1) and used to transform *T. atroviride* protoplasts. Genomic DNA from the single hygromycin-resistant colony was used corroborate by PCR that the *tgf-1* gene was replaced by the *hph* cassette. We also determined ectopic insertions of the deletion construct in the *T. atroviride* genome by qPCR. The *tgf-1* gene was detected in the wild-type strain but not in Δ *tgf-1* candidate (Table 1). The *hph* cassette was detected in a Δ *tgf-1* candidate in a single-copy, but not in the wild type strain (Table 2).

The *T. atroviride* wild type and Δ *tgf-1* strain were grown on PDA plates during 6 days under 12-light/dark regime to analyze the mutant phenotype. The Δ *tgf-1* strain showed a slow growth, poor conidiation and absence of the typical green color conidia compared to the wild type strain (Figure 3).

Since we observed an increase in global histone H3 acetylation in the wild type strain after the application of the light stimulus, we decided to investigate the contribution of TGF-1 in H3 acetylation. Unexpectedly, the western blot analysis of Δ *tgf-1* strain displayed elevated H3 acetylation levels in all tested conditions, compared to the wild type strain (Fig 4). These data suggest that TGF-1 regulates negatively other HATs, or that some HATs are compensating the loss of TGF-1.

The histone acetyltransferase TGF-1 is the coactivator of blue-light upregulated genes and is necessary for maintaining the transcript levels of the blue-light downregulated gene *bld-2* in the dark

To test whether the TGF-1 is implicated in the regulation of *blu* genes, the transcript level of four of them (*phr-1*, *grg-1*, *al-3* and *env1*) and one *bld* gene (*bld-2*) were quantified by qRT-PCR under different light conditions. The Δ *tgf-1* strain displayed a marked reduction in transcription of blue-light upregulated genes when compared to the wild type strain (Figure 5); however, we still observe the characteristic induction pattern of *phr-1* gene. We could not detect *env1* transcript while *al-3* was expressed constitutively, and at slightly higher levels in all tested conditions compared to the wild type grown in the dark (Figure 5). The *grg-1* gene showed reduced levels of transcription in Δ *tgf-1* strain compared to the wild type with an induction peak after 120 min, losing the typical pattern observed in the wild type strain (Figure 4). In the wild type strain the *bld-2* transcript showed its maximum levels in the dark, and after a light pulse the *bld-2* mRNA was downregulated, whereas the Δ *tgf-1* strain displayed low levels of *bld-2* transcript and increasing after 120 min to almost half of the wild type strain levels when grown in the dark (Figure 5). Together, these data suggest that TGF-1 could be the coactivator that mediates the blue-light response together with the BLR-1 and BLR-2 proteins. In addition, TGF-1 is also necessary to maintain the transcription levels of *bld-2* under dark conditions in *T. atroviride*.

Blue light induces TGF-1 dependent H3 acetylation in the Light Responsive Region of the *phr-1* promoter

Cervantes-Badillo *et al.* (2013) experimentally demonstrated that a segment of 50 bp on the *phr-1* promoter named Light Responsive Region (LRR) contains the necessary information for its blue-light induction and that BLR-2 binds to this region in *T. atroviride*. To determine whether blue light can induce changes in H3 acetylation pattern on the LRR, and whether these changes depend on *tgf-1*, we performed ChIP assays. Mycelia from *T. atroviride* wild-type and Δ *tgf-1* strains were grown in the dark or harvested 30 and 120 min after a blue light pulse. Cross-linked chromatin was extracted and immunoprecipitated using specific antibodies against H3 and H3-Ac. Enriched chromatins from wild type strain

were analyzed by qPCR with specific oligonucleotides designed on the *phr-1* LRR and on the control promoter of the *tef-1* gene, whose transcript is not regulated by light. Our results showed a basal H3-Ac in the dark, whereas H3-Ac chromatin was enriched on the LRR 30 min after a blue light pulse and up until 120 min after the application of the stimulus (figure 6A). The acetylation levels of H3 in a region outside of the LRR showed a slight increase 30 and 120 min after the application of the stimulus (Data not shown); whereas the acetylation pattern of *tef-1* gene promoter was constitutive (Data not shown). The H3 acetylation pattern on the LRR closely follows the blue light transcription kinetics of the *phr-1* transcript (Figure 1A). These results correlate with the fact that in many systems, the acetylation of amino tail of histone H3 is involved in transcriptional activation. Our results suggested that TGF-1 might be directly acetylating the H3 in the LRR of *phr-1* promoter. To test this hypothesis, a ChIP assay was performed using a polyclonal antibody against the *S. cerevisiae* Gcn5p protein. The immunoprecipitated chromatin under different light conditions was analyzed by qPCR for enrichment anti-TGF-1 relative to input chromatin (figure 6A). The results showed that TGF-1 is present in the LRR in the dark, it slightly decreases 30 min after a blue light pulse, reaching its maximum levels 120 min after a blue light pulse (figure 6A). Therefore we suggest that TGF-1 is present in the promoter of *phr-1* gene in the dark, ready to acetylate histone H3, once the luminous stimulus is given. This TGF-1 positioning kinetics in the LRR of *phr-1* promoter is very similar to that reported for BLR-2 in dark and light conditions respectively (Cervantes-Badillo *et al.*, 2013). On the other hand, the acetylation pattern of histone H3 on the LRR of the *phr-1* promoter was completely depleted in all tested conditions compared to the wild type strain (Figure 6B). These results showed the relevance of TGN-1 on the acetylation on the *phr-1* promoter, and probably on the promoters of the other *blu* genes.

DISCUSSION

Trichoderma atroviride responds to blue light by developing a ring of green conidia at the colony perimeter where the stimulus was given (Horwitz *et al.*, 1985). During the last two decades some members of the *Trichoderma/Hypocrea* genera have been adopted as models to dissect the molecular basis of blue light perception and transduction. However, there is

very little data on the epigenetic mechanisms of blue light perception and signal transduction.

In this work we showed for the first time the role of histone acetylation in blue light perception in *T. atroviride*. Global acetylation analysis of K9 and K14 of histone H3 showed that a blue light pulse induced acetylation reaching the highest-level 30 min after the pulse. Furthermore, the increased acetylation paralleled the *phr-1* photoinduction. This fact suggests that histone H3 acetylation plays a role during the transduction of the blue light signal in *T. atroviride*. Application of TSA to a growing culture of *T. atroviride* increased the global acetylation levels even in the dark when compared to the mock control. These data indicated that histone H3 acetylation of K9 and K14 residues are a key modification in transcriptional activation in response to the blue light stimulus.

ChIP analysis of histone H3 acetylation in the LRR of the *phr-1* promoter followed a kinetics similar to that of *phr-1* transcript, and is consistent with the data reported for *al-3* from *N. crassa* (Grimaldi *et al.*, 2006). Our results support our hypothesis that histone H3 acetylation on the *phr-1* promoter could be playing an important role in response to the light stimulus.

The Δ *tgf-1* mutant has a pleiotropic phenotype, mainly an exacerbated slow growth and produced few non-pigmented conidia. Our results are in agreement with those reported for the *ngf-1* mutant in *N. crassa* (Grimaldi *et al.*, 2006). These data suggests a key role of TGF-1 in growth and development in *T. atroviride*. This phenotype could be explained by the important role that Gcn5p plays on the regulation of genes involved in the different stages of the cell cycle in other organisms. In *A. thaliana* a *gcn5* mutant results in a dwarf phenotype, with a decrease in the number and size of inflorescences, and the flowers presented small siliques with few seeds when compared to the wild type plant. It is important to note that genes involved in development and cell division were downregulated in such mutant (Vlachonasios *et al.*, 2003). Deletion of *GCN5* in *S. cerevisiae* led to an arrest in G2M phase of the cell cycle, pointing the importance of Gcn5p for progression of cell cycle (Zhang *et al.*, 1998). Interestingly, Gcn5p acetylates the lysine 25 (K25) of the

chromatin remodeler Rsc4, and a mutation in this amino acid leads to defects in cell growth in *S. cerevisiae* (VanDemark *et al.*, 2007).

Analysis of the participation of TGF-1 on the transcriptional regulation of blue light responsive genes, showed decreased transcription levels of these genes in a $\Delta tgf-1$ background when compared to the wild type strain. Even though *phr-1* transcript levels are relatively low at all tested times, the induction pattern is very similar to the wild type, which suggests the participation of TGF-1 as coactivator of this gene. When the *env1* and *al-3* genes were analyzed in a $\Delta tgf-1$ background they showed almost non-detectable levels or slightly higher levels of their transcripts in the dark respectively, compared to the wild type strain. The $\Delta tgf-1$ strain showed similar levels of *al-3* and *env1* at 30 and 120 min, contrasting with the high levels detected in the wild type strain. These results confirm the importance of TGF-1 in maintaining low levels of *al-3* and *env1* transcripts in the dark, and indicate its relevance in the activation of these genes after the application of light. The *bld-2* gene is normally expressed at high levels in the dark, and a light pulse represses its transcription in a wild type background. Interestingly, in the $\Delta tgf-1$ background *bld-2* showed ten times less expression levels in the dark, and application of a light pulse showed not effect after 30 min, but after 120 min the transcript increased significantly. This fact reveals the role of TGF-1 in maintaining high levels of *bld-2* in the dark and in the correct expression of this gene after a light stimulus. Together these results suggest that TGF-1 and the BLR complex interact in order to regulate the blue light responsive genes in *T. atroviride*. The physical interaction of NGF-1 and WC-1 in the dark was recently demonstrated in *N. crassa*. It was also proven that this interaction is necessary for the acetylation of lysine 14 of histone H3, which positively affects the coactivation of *al-3* (Brenna *et al.*, 2012). In addition, the presence of BLR-2 on the LRR of the *phr-1* promoter in the dark was also demonstrated (Cervantes-Badillo *et al.*, 2013). Together these results led us to propose that the BLRC is interacting with TGF-1, probably through the LXXLL motif in BLR-1 (Brenna *et al.*, 2012) to coactivate the expression of blue light responsive genes and to maintain the expression of *bld-2* in darkness, in a similar way to the blue light response in *N. crassa*. Furthermore these data reinforce the role of HATs in maintaining an

open chromatin to allow the transcription machinery access the target promoters (Kuo and Allis, 1998; Workman and Kingston, 1998).

ENV1 is involved in desensitization of blue light responsive genes in *Trichoderma* (Castellanos *et al.*, 2010). The $\Delta tgf-1$ strain presented low levels of *env1* transcript in all tested conditions. In addition the typical kinetics of blue light induced genes was observed for the *grg-1* gene in the wild type. The *grg-1* gene is blue light induced in the wild type strain, however, in the $\Delta tgf-1$ strain there are low levels of the *grg-1* transcript in the dark compared to the wild type. 30 min after the application of a light stimulus, *grg-1* transcript levels start increasing, even after 120 min. This result could be explained by the absence of *env1* transcript, whose product the ENV1 protein is involved in the negative regulation of blue light inducible genes (Castellanos *et al.*, 2010). However, this statement contradicts the results obtained for *phr-1*, which actually was desensitized in the $\Delta tgf-1$ background. This indicates that *Trichoderma* has several mechanisms to activate and repress blue light responsive genes. In this sense, it was proposed that the BLR proteins have a dual role participating as activators and repressors in the regulation of *blu* and *bld* genes respectively in *T. atroviride* (Rosales-Saavedra *et al.*, 2006).

Even though when *Trichoderma* does not produce β -carotenes, it contains the orthologous gene to *al-3* from *N. crassa*, which is involved in the synthesis of these pigments in *N. crassa* (Carattoli *et al.*, 1991). Probably, the *Trichoderma* orthologue encodes for a protein involved in the synthesis of pigments that confer conidia the typical green color in the wild type strain. The $\Delta ngf-1$ mutant showed a pale pink mycelia after light stimulation, and few non-pigmented conidia (Grimaldi *et al.*, 2006). Furthermore, the *gcn5-1* in *Arabidopsis* showed chlorotic leaves under constant illumination (Vlachonasios *et al.*, 2003), reinforcing the role of TGF-1 in the regulation of the production of pigments in different organisms. Together our results indicate that TGF-1 regulates in a different way the responsive genes in *T. atroviride*, suggesting the participation of more regulators in addition to the BLR complex.

High levels of global histone H3 acetylation were detected in the $\Delta tgf-1$ strain in all tested conditions, compared to the wild type strain. These results could suggest that TGF-1

negatively regulates other HATs whose targets could be the lysine K9 and K14 in histone H3. We have identified eight HATs (IDs: 277575, 261634, 222668, 275394, 263693, 232004, 278283 and 265412) in the *T. atroviride* genome (Uresti-Rivera and Casas-Flores, unpublished results) that could compensate for the absence of TGF-1. Two lines of evidence support our hypothesis, since in Arabidopsis PCAT1 that encodes for a HAT related to CBP is expressed in a *gcn5-1* background contrasting with the wild type plants (Vlachonasios *et al.*, 2003). In addition, the *S. cerevisiae* *GCN5*Δ mutant showed acetylation of lysine residues K9 and K14 of histone H3 at almost the same levels as the wild type strain. The enzyme responsible for this acetylation is the Sas3p HAT, since a double permissive mutant *GCN5*Δ *SAS3*Δ showed no acetylation in the amino termini of histone H3. This decrease in acetylation of H3 histone was not observed in a *SAS3*Δ background (Howe *et al.*, 2001).

Despite the high levels of histone H3 acetylation in *Δtgf-1* strain, we were unable to detect acetylation of histone H3 on the LRR of *phr-1* promoter after a blue light pulse, which indicates a specificity of TGF-1 coactivator activity in the *phr-1* promoter, and possibly also in the promoters of the other blue light responsive genes.

In *N. crassa* the presence of the LXXLL motif in WC-1 is essential to recruit NGF-1 to the promoter of *al-3* gene, which is necessary for the acetylation of histone H3 and the photoactivation of this gene (Brenna *et al.*, 2012). Our results of global acetylation of histone H3 in *Δblr-1* background, showed no acetylation in histone H3.

In this work we are reporting for the first time the involvement of epigenetic mechanisms in blue light perception in *T. atroviride*. Deletion of *tgf-1*, which encodes the HAT Gcn5p orthologue from *S. cerevisiae*, results in a pleiotropic phenotype that impacts mainly the growth and conidiation of the *Δtgf-1* mutant. We showed the correlation of lysine K9 and/or K14 acetylation of histone H3 on the LRR of *phr-1* promoter and induction of this gene after a blue light stimulus. This acetylation is probably performed in a specific way by TGF-1.

Acknowledgements

This work was supported by grant SEP-CONACYT 83798 to Alfredo Herrera-Estrella and Sergio Casas-Flores. EEUR, MGCB, EYGR and TMC are indebted to CONACYT for Ph. D. and Master of Science scholarships.

References

1. Ballario, P., Talora, C., Galli, D., Linden, H. and Macino, G. (1998). Roles in dimerization and blue light photoresponse of the PAS and LOV domains of *Neurospora crassa* White Collar Proteins, *Mol Microbiol* **29**, 719-729.
2. Ballario, P., Vittorioso, P., Magrelli, A., Talora, C., Cabibbo, A. and Macino G (1996) White collar-1, a central regulator of blue light responses in *Neurospora*, is a zinc finger protein, *EMBO J* **15**, 1650-1657.
3. Belozerskaya TA, Gessler NN, Isakova EP, Deryabina YI (2011) *Neurospora crassa* Light Signal Transduction Is Affected by ROS, *J Signal Transduct.* **2012**, 2012:791963.
4. Berrocal-Tito, G. M., Esquivel-Naranjo, E. U., Horwitz, B. A. and Herrera-Estrella, A (2007) *Trichoderma atroviride* PHR1, a fungal photolyase responsible for DNA repair, autoregulates its own photoinduction, *Eukaryot. Cell* **6**, 1682-1692.
5. Berrocal-Tito, G., Sametz-Baron, L., Eichenberg, K., Horwitz, B. A. & Herrera-Estrella, A (1999) Rapid blue light regulation of a *Trichoderma harzianum* photolyase gene, *J Biol Chem* **274**, 14288–14294.
6. Bing Li, Michael Carey, Jerry L. Workman (2007) The Role of Chromatin during Transcription *Cell* **128**, 707-719.
7. Brenna A, Grimaldi B, Filetici P and Paola Ballario (2012) Physical association of the WC-1 photoreceptor and the histone acetyltransferase NGF-1 is required for blue light signal transduction in *Neurospora crassa*, *Mol Biol Cell* **23**,3863-72.

8. Carattoli, A., Romano, R., Ballario, P., Morelli, G. & Macino, G (1991) The *Neurospora crassa* carotenoid biosynthetic gene (albino 3) reveals highly conserved regions among prenyltransferases, *J Biol Chem* **266**, 5854–5859.
9. Carreras-Villaseñor N, Sánchez-Arreguin JA & Herrera-Estrella A (2012) *Trichoderma*: sensing the environment for survival and dispersal, *Microbiol* **158**, 3-16.
10. Carroll AM, Sweigard JA & Valent B (1994) Improved vectors for selecting resistance to hygromycin, *Fungal Genet Newsl* **41**, 22.
11. Casas-Flores and Herrera Estrella (2013) The Influence of Light on the Biology of *Trichoderma*. *Trichoderma: Biology and Applications* © CAB International. (eds P.K. Mukherjee et al.).
12. Casas-Flores S, Rios-Momberg M, Rosales-Saavedra T, Martinez-Hernandez P, Olmedo-Monfil V & Herrera-Estrella A (2006) Cross talk between a fungal blue-light perception system and the cyclic AMP signaling pathway, *Eukaryot Cell* **5**, 499-506.
13. Casas-Flores, S., Rios-Momberg, M., Bibbins, M., Ponce-Noyola, P. and HerreraEstrella (2004) BLR-1 and BLR-2 are key regulatory elements for photoconidiation and mycelial grown in *T. atroviride*, *Microbiol* **150**, 3561-3569.
14. Castellanos F, Schmoll M, Martínez P, Tisch D, Kubicek CP, Herrera-Estrella A & Esquivel-Naranjo, EU (2010) Crucial factors of the light perception machinery and their impact on growth and cellulase gene transcription in *Trichoderma reesei*, *Fungal Genet Biol* **47**, 468-476.
15. Cervantes-Badillo Mayte Guadalupe, Muñoz-Centeno Tania, Uresti-Rivera Edith Elena, Argüello-Astorga Gerardo Rafael and Casas-Flores Sergio (2013) The *Trichoderma atroviride* photolyase-encoding gene is transcriptionally regulated by non-canonical light response elements, *FEBS J*.
16. Chen CH, Ringelberg CS, Gross RH, Dunlap JC & Loros JJ (2009) Genome-wide analysis of light-inducible responses reveals hierarchical light signalling in *Neurospora*, *EMBO J* **28**, 1029-1042.
17. Chen, C.L., Kuo, H.C., Tung, S.Y., Hsu, P.W.C., Wang, C.L., Seibel, C., Schmoll, M., Chen, R.S. and Wang, T.F (2012) Blue light acts as a double-edged sword in

- regulating sexual development of *Hypocrea jecorina* (*Trichoderma reesei*), *PLoS ONE* **7**, e44969.
18. Cheng, M., Chory, J. and Fankhauser, C (2004) Light signal transduction in higher plants, *Annu Rev Genet* **38**, 87-117.
 19. Cheng, P., Yang, Y., Gardner, K. H. and Liu, Y (2002) PAS domain-mediated WC1/WC2 interaction is essential for maintaining of steady-state level of WC-1 and of function of both proteins in circadian clock and light responses of *Neurospora*, *Mol Cell Biol* **22**, 517-524.
 20. Cheng, P., Yang, Y., Wang, L., He, Q. and Liu, Y (2003) WHITE COLLAR-1, a multifunctional *Neurospora* protein involved in the circadian feedback loops, light sensing and transcription repression of *wc-2*, *J Biol Chem* **278**, 3801-3808.
 21. Clapier CR, Cairns BR. (2009) The biology of chromatin remodeling complexes, *Annu Rev Biochem* **78**, 273–304.
 22. Crosthwaite S., Dunlap, J. and Loros, J (1997) *Neurospora wc-1* and *wc-2*: Transcription, photoresponses and the origins of circadian rhythmicity, *Science* **276**, 763-769.
 23. Crosthwaite, S., Loros, J. and Dunlap, J (1995) Light-Induced resetting of a circadian clock is mediated by a rapid increase in *frequency* transcript, *Cell* **81**, 1003–1012.
 24. Cullen, D.a, Leong, S.A.b, Wilson, L.J.c and Henner, D.J.d (1987) Transformation of *Aspergillus nidulans* with the hygromycin-resistance gene, *hph*, *Gene* **57**, 21-26.
 25. J. C. Dunlap and J. J. Loros (2004) The *Neurospora* circadian system, *Journal of Biological Rhythms* **19**, 414-424.
 26. Dyda F., Klein D.C., Hickman A.B (2000) GCN5-related N-acetyltransferases: a structural overview, *Annu Rev Biophys Biomol Struct* **29**, 81-103.
 27. Esquivel-Naranjo EU & Herrera-Estrella A (2007) Enhanced responsiveness and sensitivity to blue light by *blr-2* overexpression in *Trichoderma atroviride*, *Microbiol* **153**, 3909-3922.
 28. Friedl, M.A., Kubicek, C.P. and Druzhinina, I.S (2008a) Carbon source dependence and photostimulation of conidiation in *Hypocrea atroviridis*. *Applied and Environmental Microbiology* **74**, 245–250.
-

29. Friedl, M.A., Schmoll, M., Kubicek, C.P. and Druzhinina, I.S. (2008b) Photostimulation of *Hypocrea atroviridis* growth occurs due to a cross-talk of carbon metabolism, blue light receptors and response to oxidative stress, *Microbiology* **154**, 1229–1241.
30. Froehlich, A. C., Liu, Y., Loros, J. J. and Dunlap J. C (2002). White collar-1, a circadian blue light photoreceptor, binding to the *frequency* promoter, *Science* **297**, 815-819.
31. Georgakopoulos, T., and G. Thireos (1992) Two distinct yeast transcriptional activators require the function of the GCN5 protein to promote normal levels of transcription. *EMBO J* **11**, 4145–4152.
32. Grant, P. A., L. Duggan, J. Cote, S. M. Roberts, J. E. Brownell, R. Candau, R. Ohba, T. Owen-Hughes, C. D. Allis, F. Winston, S. L. Berger, and J. L. Workman (1997) Yeast Gen5 functions in two multisubunit complexes to acetylate nucleosomal histones: characterization of an Ada complex and the SAGA (Spt/Ada) complex, *Genes Dev* **11**, 1640-50.
33. Gresik, M., Kolarova, N. and Farkas, V (1988) Membrane potential, ATP, and cyclic AMP changes induced by light in *Trichoderma viride*, *Exp Mycol* **12**, 295-301.
34. Gresik, M., Kolarova, N. and Farkas, V (1989) Light-stimulated phosphorylation of proteins in cell free extracts from *Trichoderma viride*, *FEBS Lett.* **12**, 185-187.
35. Grewal, S. I. S., M. J. Bonaduce, and A. J. S. Klar (1998) Histone deacetylase homologs regulate epigenetic inheritance of transcriptional silencing and chromosome segregation in fission yeast. *Genetics*, **150**, 563-576.
36. Grimaldi, B., Coiro, P., Filetici, P., Berge, E., Dobosy, J. R., Freitag, M., Selker, E. U and Ballario, P (2006) The *Neurospora crassa* White Collar-1 dependent blue light response requires acetylation of histone H3 lysine 14 by NGF-1, *Mol Biol Cel* **17**, 4576-4583.
37. Grunstein Michael (1997) Histone acetylation in chromatin structure and transcription, *Nature* **389**, 349-352.
38. Hanahan D, Weinberg RA. (2000) The hallmarks of cancer, *Cell* **100**, 57–70.

39. Harding RW, Melles S (1983) Genetic analysis of phototropism of *Neurospora crassa* perithecial beaks using *white collar* and *albino* mutants, *Plant Physiol* **72**, 996-1000.
40. Hassig Christian A., Tong Jeffrey K., Fleischer Tracey C., Owa Takashi, Grable Phyllis G., Ayer Donald E., Schreiber Stuart L (1998) A role for histone deacetylase activity in HDAC1-mediated transcriptional repression, *PNAS* **95**, 3519-3524.
41. He, Q., and Liu, Y (2005) Molecular mechanism of light responses in *Neurospora*: from light-induced transcription to photoadaptation, *Genes Dev* **19**, 2888-2899.
42. Heintzen, C. and Liu, Y (2007) "The *Neurospora crassa* Circadia Clock," *Advances in Genetics* **58**, 25–66.
43. Herrera-Estrella, A. and Horwitz, B (2007) Looking through the eyes of fungi: molecular genetics of photoreception, *Mol Microbiol* **64**, 5-15.
44. Hodawadekar S C, Marmorstein R (2007) Chemistry of acetyl transfer by histone modifying enzymes: structure, mechanism and implications for effector design, *Oncogene* (2007) **26**, 5528–5540.
45. Horwitz, B. A., Gressel, J., and Malkin, S (1985) Photoperception mutants in *Trichoderma*: mutants that sporulate in response to stress but not light, *Curr Genet* **9**, 605-613.
46. Howe L, Auston D, Grant P, John S, Cook RG, Workman JL, Pillus L (2001) Histone H3 specific acetyltransferases are essential for cell cycle progression. *Genes Dev.* **3**, 3144–3154.
47. Ikegami S., Ooe Y., Shimizu T., Kasahara T., Tsuruta T., Kijima, M (1993) Accumulation of multiacetylated forms of histones by trichostatin A and its developmental consequences on early starfish embryos, *Roux Arch Dev Biol* **202**,144–151.
48. Jenuwein T, Allis C (2001) Translating the histone code, *Science* **293**, 1074–80.
49. Kadosh David , Struhl Kevin (1998) Histone deacetylase activity of Rpd3 is important for transcriptional repression in vivo, *Genes & Dev.* **12**, 797-805.
50. Kenneth K. Lee, Jerry L. Workman (2007) Histone acetyltransferase complexes: one size doesn't fit all, *Nat Rev Mol Cell Biol* **8**, 284-295.

51. Ko, W. H., Nash, A. I. and Gardner, K. H (2007) A LOVely view of blue light Photosensing, *Nat Chem Biol* **3**, 372-374.
52. Komon-Zelazowska, M., Neuhof, T., Dieckmann, R., von Döhren, H., Herrera Estrella, A., Kubicek, C.P. and Druzhinina, I.S. (2007) Formation of atroviridin by *Hypocrea atroviridis* is conidiation associated and positively regulated by blue light and the G proteína GNA3, *Eukaryotic Cell* **6**, 2332–2342.
53. Kritskii MS, Belozerskaia TA, Sokolovskii VIu, Filippovich Siu (2005) Photoreceptor apparatus of a fungus *Neurospora crassa*, *Mol Biol (Mosk)* **39**, 602-17.
54. Kuo MH, Brownell JE, Sobel RE, Ranalli TA, Cook RG, Edmondson DG, Roth SY, Allis CD.(1996) Transcription-linked acetylation by Gcn5p of histones H3 and H4 at specific lysines, *Nature* **383**, 269–272.
55. Kuo Min-Hao and Allis C. David (1998) Roles of histone acetyltransferases and deacetylases in gene regulation, *BioEssays* **20**, 615–626.
56. Linden, H. and Macino, G (1997) White Collar 2, a partner in blue light signal transduction, controlling expression of light-regulated genes in *Neurospora crassa*, *EMBO J* **16**, 98-109.
57. Liu, Y., He, Q. and Cheng, P. (2003). Photoperception in *Neurospora*: a tale of two White Collar proteins, *Cell Mol Life Sci* **60**, 2131-2138.
58. Livak KJ, Schmittgen TD (2001) Analysis of relative gene expression data using real-time quantitative PCR and the $2^{-\Delta\Delta CT}$ method, *Methods* **25**, 402-408.
59. Luo RX, Dean DC (1999) Chromatin remodeling and transcriptional regulation, *J Natl Cancer Inst* **91**, 1288-94.
60. Purschwitz, J., Muller, S., Kastner, C., and Fischer, R (2006) Seeing the rainbow: light sensing in fungi, *Curr Opin Microbiol.* **9**, 566–571.
61. Rodríguez-Romero J, Hedtke M, Kastner C, Muller S & Fischer R (2010) Fungi, hidden in soil or up in the air: light makes a difference, *Annu Rev Microbiol* **64**, 585-610.
62. Rosales-Saavedra, T., Esquivel-Naranjo, E.U., Casas- Flores, S., Martinez-Hernandez, P., Ibarra-Laclette, E., Cortes-Penagos, C., and Herrera-Estrella, A

- (2006) Novel light-regulated genes in *Trichoderma atroviride*: a dissection by cDNA microarrays, *Microbiology* **152**, 3305–3317.
63. Saleh, A., V. Lang, R. Cook, and C. J. Brandl (1997) Identification of native complexes containing the yeast coactivator/repressor proteins NGG1/ADA3 and ADA2, *J Biol Chem* **272**, 5571-8.
 64. Sambrook J, Fritsch EF, and Maniatis T. Molecular Cloning: A Laboratory Manual. 2nd edition. New York: Cold Spring Harbor Laboratory Press; 1989.
 65. Schmidhauser, T., Lauter F., Schumacher, M., Zhou, W., Russo V. and Yanofsky, C (1994) Characterization of *al-2*, the phytoene synthase gene of *Neurospora crassa*. Cloning, sequence analysis, and photoregulation, *J Biol Chem* **269**, 12060-12066.
 66. Seibel, C., Tisch, D., Kubicek, C.P. and Schmoll, M. (2012) ENVOY is a major determinant in regulation of sexual development in *Hypocrea jecorina* (*Trichoderma reesei*), *Eukaryotic Cell* **11**, 885–896.
 67. Sendra, R., C. Tse, and J. C. Hansen (2000) The yeast histone acetyltransferase A2 complex, but not free Gcn5p, binds stably to nucleosomal arrays, *J Biol Chem* **275**, 24928-34.
 68. Smith KM, Sancar G, Dekhang R, Sullivan CM, Li S, Tag AG, Sancar C, Bredeweg EL, Priest HD, McCormick RF, Thomas TL, Carrington JC, Stajich JE, Bell-Pedersen D, Brunner M & Freitag M (2010) Transcription factors in light and circadian clock signaling networks revealed by genome wide mapping of direct targets for *Neurospora* white collar complex, *Eukaryot Cell* **9**, 1549-1556.
 69. Sommer, T., Chambers, J., Eberle, J., Lauter, F. and Russo, V. (1989). Fast light regulated genes of *Neurospora crassa*, *Nucleic Acids Res* **17**, 5713-5723.
 70. Strahl B, Allis C (2000) The language of covalent histone modifications, *Nature* **403**, 41–5.
 71. VanDemark AP, Kasten MM, Ferris E, Heroux A, Hill CP, Cairns BR (2007) Autoregulation of the *rsc4* tandem bromodomain by *gcn5* acetylation, *Mol Cell* **27**, 817–828.
 72. Vlachonasios KE, Thomashow MF, Triezenberg SJ (2003) Disruption mutations of ADA2b and GCN5 transcriptional adaptor genes dramatically affect *Arabidopsis* growth, development, and gene expression, *Plant Cell* **15**, 626-38.
-

73. Workman JL, Kingston RE (1998) Alteration of nucleosome structure as a mechanism of transcriptional regulation, *Annu Rev Biochem* **67**, 545-79.
74. Zhang, W., Bone, J.R., Edmondson, D.G., Turner, B.M., and Roth, S.Y (1998) Essential and redundant functions of histone acetylation revealed by mutation of target lysines and loss of the Gcn5p acetyltransferases, *EMBO J* **17**, 3155–3167.

Figure legends

Figure 1. Blue light induces global histone H3 acetylation in *T. atroviride*. (A) qRT-PCR analysis of the *phr-1* gene using total RNA extracted from the wild type strain mycelia exposed to 1200 μ moles of blue light, and harvested 30 and 120 min after the light pulse or from mycelia of the wild type strain grown in the dark as a control. *tef-1* was used as non-blue light inducible gene. Data shown are representative of two independent experiments with three replicates in each experiment. (B and C) Histone H3 acetylation was analyzed by western blot using total protein extracts from the mycelia grown in the dark or 30 and 120 min after the application of 1200 μ moles of blue light. (B) Non TSA-treated wild type strain. (C) Wild type strain treated during 6 hours with TSA (300nM) before the blue light stimulus. Blots were hybridized using histone H3 or H3-Ac antisera. Images are representative of two independent experiments. The asterisk indicates a nonspecific band used as loading control.

Figure 2. Amino acid sequence alignment of the predicted TGF-1 protein with different fungal Gcn5p homologues. Multiple sequence alignment was conducted using the ClustalW algorithm and was visualized by BOXSHADE 3.21. Amino acid sequence identity is displayed with black shading; amino acid similarities are highlighted in grey. The GenBank accession numbers are: EHK39839.1 for *Trichoderma atroviride*; CAA97281.1 for *Saccharomyces cerevisiae*; XP_661225.1 for *Aspergillus nidulans*; XP_380456.1 for *Gibberella zeae* and ABD92369.1 for *Neurospora crassa*. Solid and dashed underlines indicate the catalytic HAT domain and bromodomain, respectively.

Figure 3. Deletion of *tgf-1* affects growth and development in *T. atroviride*. Plugs from actively growing mycelia of the wild type and Δ *tgf-1* strains were inoculated in the center of Petri dishes containing PDA at 28°C under 12/12 h light/dark cycles for 6 days, and photographed.

Figure 4. Deletion of Δ *blr-1* and Δ *tgf-1* led to the misregulation of blue light induced acetylation of histone H3 in *T. atroviride*. Western blot analysis of acetylated histone H3

were assessed using total protein extracts from mycelia of $\Delta blr-1$ and $\Delta tgf-1$ strains grown in the dark or exposed to 1200 μmoles of blue light, returned to the dark and harvested 30 and 120 min after the application of the stimulus. Blots were hybridized using a specific N-Terminal tail of Histone H3 antiserum. The gel stained with Comassie is shown to compare the amount loaded in each lane. Images are representative of two independent experiments.

Figure 5. TGF-1 is the coactivator of *blu* genes and is necessary for *bld-1* transcription in the dark. Total RNA from mycelia of the wild type (black bars) and $\Delta tgf-1$ (grey bars) strains grown in the dark or exposed to a 1200 $\mu\text{M m}^{-2}$ of blue light were extracted at the indicated times, and analyzed by qRT-PCR. The data were normalized with the expression of the housekeeping gene *tef-1*. Data are representative of two independent experiments with three replicates in each experiment. The graphs show the mean expression levels \pm SD.

Figure 6. TGF-1 is present on the LRR of the *phr-1* promoter in the darkness and is necessary for histone H3 acetylation on the LRR of the *phr-1* promoter after a blue light stimulus in *T. atroviride*. (A) Quantitative chromatin immunoprecipitation assays using specific H3, H3-Ac, Gcn5p and BLR-2 antisera were assessed with crosslinked mycelia of the wild type strain, 30 and 120 min after the application of 1200 $\mu\text{M m}^{-2}$ of blue light. Crosslinked mycelium of the wild type strain grown in the dark was used as non-blue light induced control. Specific primers designed on the LRR were used to amplify the crosslinked chromatin. Data are representative of two independent experiments with three replicates in each experiment. The graphs show the mean expression levels \pm SD. (B) Qualitative chromatin immunoprecipitation assays using specific histone H3 and acH3 antisera were assessed with crosslinked mycelia of the wild type and $\Delta tgf-1$ strains, 30 and 120 min after the application of 1200 $\mu\text{M m}^{-2}$ of blue light. Crosslinked mycelia of the wild type or $\Delta tgf-1$ strains grown in the dark was used as non-blue light induced control. Specific primers designed on the LRR were used to amplify the crosslinked chromatin. Images are representative of two independent experiment

Figures

Figure 1

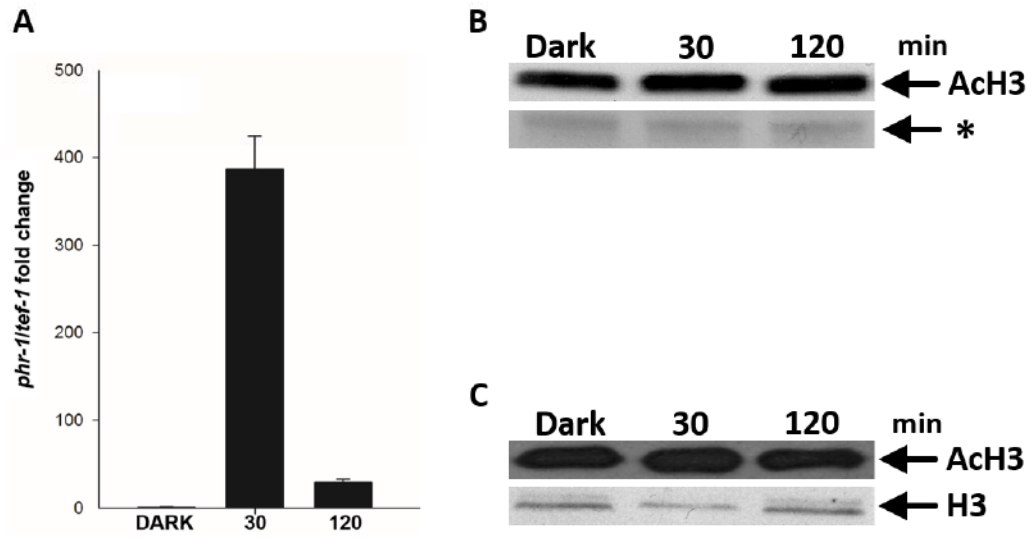

Figure 2

```

G. zeae      1  --MLLHPIISNFSLNNIKSQQPGLSPHQSCQTKVSPHYATATRVKLLTYGQTDGKRKAE
T. atroviride 1  -----MADIKEE-----GGKRKAE
N. crassa    1  -----MS-----IDTKRKAT
A. nidulans  1  MGFVSVMVAGEKRI GAVRSKHRVIVCGVLVIQLASSN-----LQTTVQGD RKAS
S. cerevisiae 1  --MVTKHQIEEDHLDGATIDPEVKRVKLENNVEEIQPE-----QAETNKQEGT
.
.
.
G. zeae      59  EEPSSPTPSKRIKQDSS---AEPPEK---KPDIKRIE--FPEKPAVLEERNGEIEFRVFN
T. atroviride 15  DEPSSPAASKRVKQDSDSVEEEAEK---SAELKLIIP--FPEKPAVLEERNGEIEFRVFN
N. crassa    11  EEPSPSSAKRIKHSN--EENETK---KPKIPAIIP--FPEKPAVLEERDGEIEFRVFN
A. nidulans  51  EEPALSPDSQQSKKTRID--SPREL---KPELRIVE--FPEKPAVLEERNGEIEFRVFN
S. cerevisiae 47  DKENKKGKFEKETERIGGSEVVTVEKGI VKEFDGVEYTFKERFSPVVEENEGKIEFRVFN
.
.
.
G. zeae      111 NDNEREALIIILTGLKCI FQKQLPKMPKDYIARLVYDRTHLSIAIVKKPLEVGGITYRPF
T. atroviride 70  NDNERESLIILTGLKCI FQKQLPKMPKDYIARLVYDRTHLSIAIVKKPLEVGGITYRPF
N. crassa    65  NDGERESLIILTGLKCI FQKQLPKMPKDYIARLVYDRTHLSIAIVKKPLEVGGITYRPF
A. nidulans  104 NDGSRDSLIILTGLKCI FQKQLPKMPKDYIARLVYDRSHLSIAIVKHPLEVGGITYRPF
S. cerevisiae 107 NDNTKENMMVLTGLKNI FQKQLPKMPKEYIARLVYDRSHLSMAVIRKPLIVVGGITYRPF
.
.
.
G. zeae      171  KGRRF AEIVFCAISSDQVKGYG AHLMSHLKDYVKATSDVMHFLT YADNYAIGYFKKQGF
T. atroviride 130 KGRQFAEIVFCAISSDQVKGYG AHLMSHLKDYVKATSDVMHFLT YADNYAIGYFKKQGF
N. crassa    125 KGRQFAEIVFCAISSDQVKGYG AHLMSHLKDYVKATSDVMHFLT YADNYAIGYFKKQGF
A. nidulans  164 NSRFAEIVFCAISSDQVKGYG AHLMSHLKDYVKATSDIMHFLT YADNYAIGYFKKQGF
S. cerevisiae 167 DKRF AEIVFCAISSTEQVRGYGAHLMNHLKDYVNRNTSNIKYFLTYADNYAIGYFKKQGF
.
.
.
G. zeae      231  TKEITLDKIVVMGYIKDYEGGTIMQCSMLPRIRYLEMGRMLLKQKECVQAKIRAYSKSHN
T. atroviride 190 TKEITLTKIVVMGYIKDYEGGTIMQCSMLPRIRYLEMGRMLLKQKECVQAKIRAYSKSHN
N. crassa    185 TKEITLDKSVVMGYIKDYEGGTIMQCSMLPRIRYLEMGRMLLKQKECVQAKIRAYSKSHI
A. nidulans  224 TKEIQLDSTVMGYIKDYEGGTIMQCTMLPRIRYLESGRMLLKQKEAVFAKIRAFSKSHI
S. cerevisiae 227 TKEITLDKSTVMGYIKDYEGGTIMQCSMLPRIRYLDAGKILLIQEAAIRKIRTIISKSHI
.
.
.
G. zeae      291  IHPPPKEWK--NGITETINPLDI PAIRASGWS PDMDELARQPRHGFNPNQLLHLLNDLQNH
T. atroviride 250 IHPPPKEWK--NGIRETINPLDI PAIRASGWS PDMDELARQPRHGFNPNQLLHLLNDLQNH
N. crassa    245 VHPPPKQWK--NGVTPIDPLSVAI PAIRASGWS PDMDELARQPRHGFNPNQLLHLLNDLQNH
A. nidulans  284 IHPPPKEWK--NGPVKIDPLSIPA I KESGWS PDMDELARQPRHGFNPNQLLHLLNDLQNH
S. cerevisiae 287 VREGLEQPKDINNIKPIDEMTIPGLKEAGWIPMDALAQRPKRGHDAATQNLITELQNH
.
.
.
G. zeae      349  NSAWPFLVPVNRDDVADYYDVIVKEPMDLSTMESKLEADQYLTPEDFIKDARLIFDNCRRKY
T. atroviride 308 NSAWPFLVPVNRDDVADYYDVIVKEPMDLSTMESKLEADQYATPEDFIKDARLIFDNCRRKY
N. crassa    303 ASSWPFLVPVNKDEVHDYYDVIVKEPMDLSTMEDKLEKQYNTPEDFIKDARLIFDNCRRKY
A. nidulans  342 SAAWPFTQPVNKDEVLDYYEVIKEPMDLSTMEKHEKDMYPTPEDFIKDARLIFDNCRRY
S. cerevisiae 347 AAAWPFLQPVNKDEVDDYYDFI KE PMDLSTMEIKLESNKYQKMEDFIYDARLVFNCRMY
.
.
.
G. zeae      409  NNESTPYAKSANKLEKFMWQI IKA IPEWSHLEPEK
T. atroviride 368 NNESTPYAKSANKLEKFMWQI IKA IPEWSHLEPK
N. crassa    363 NNENTPYAKSANKLEKFMWQI IKA IPEWSHLEP--
A. nidulans  402 NNENTPYAKSANKLEKFMWQI I IKA IPEWSVSTI--
S. cerevisiae 407 NGENTSYKYNRLEKEFENKVIK IPEVSHLID--
.
.
.

```

Figure 3

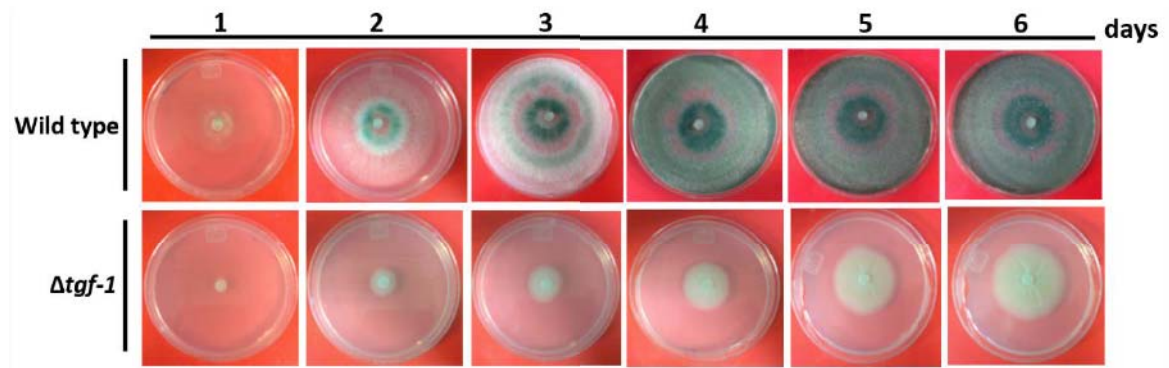

Figure 4

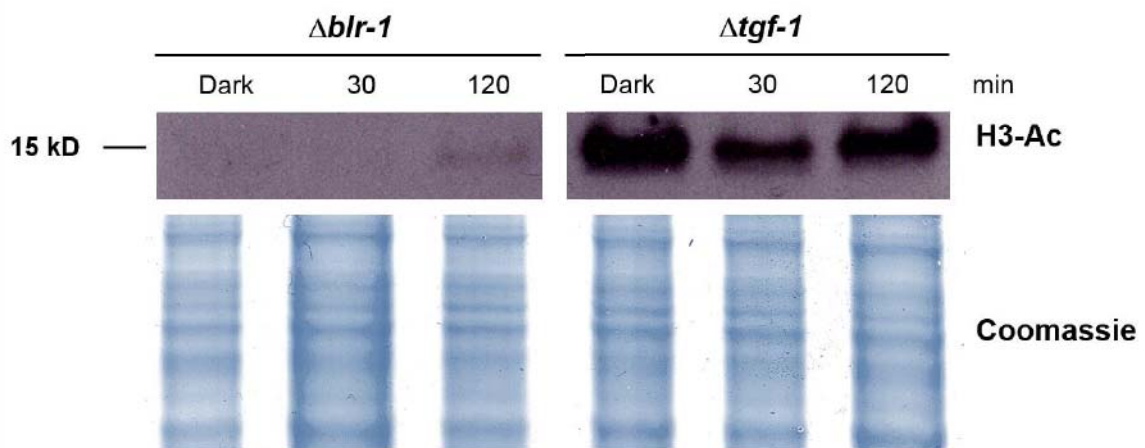

Figure 5

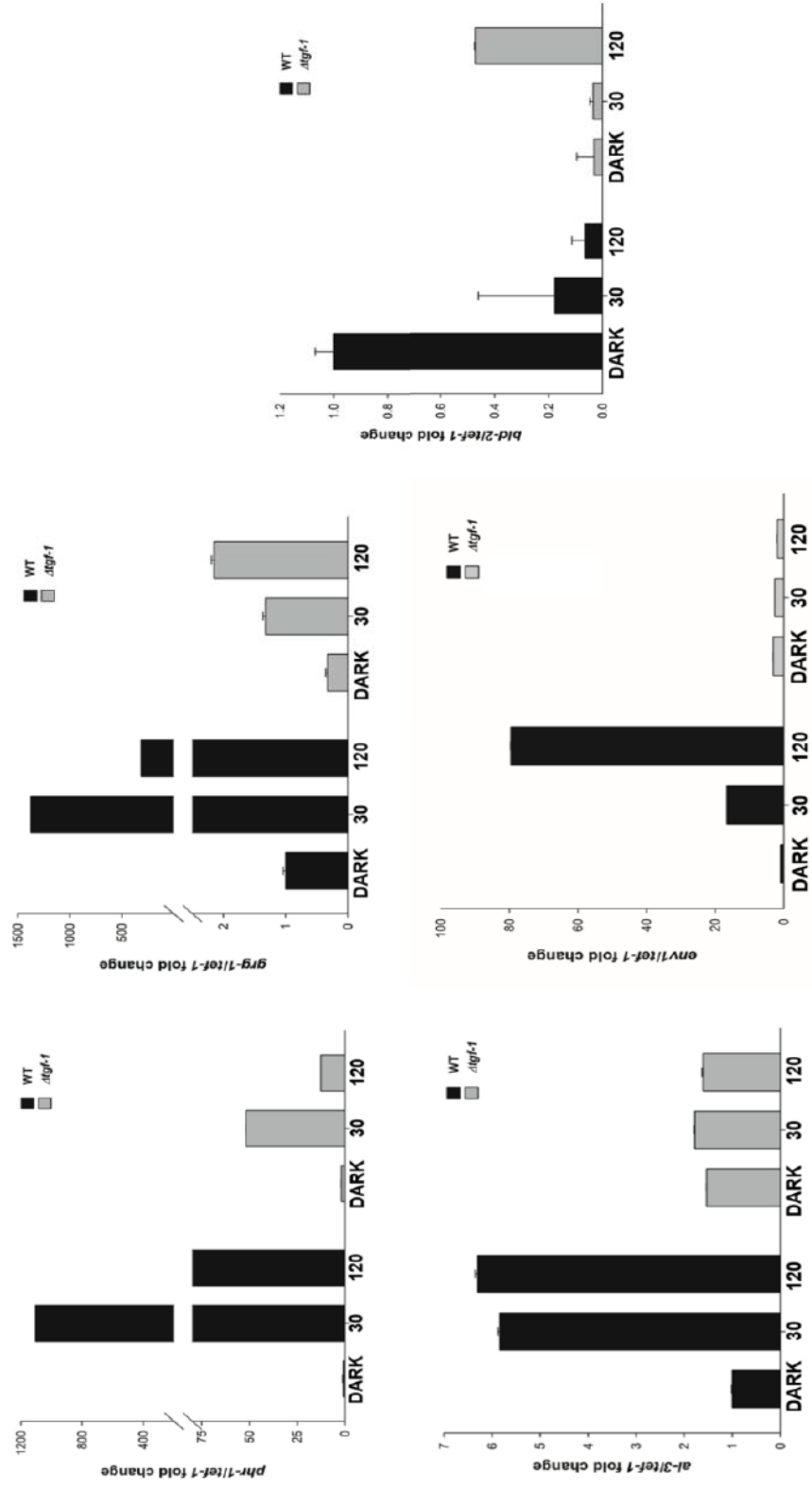

Figure 6

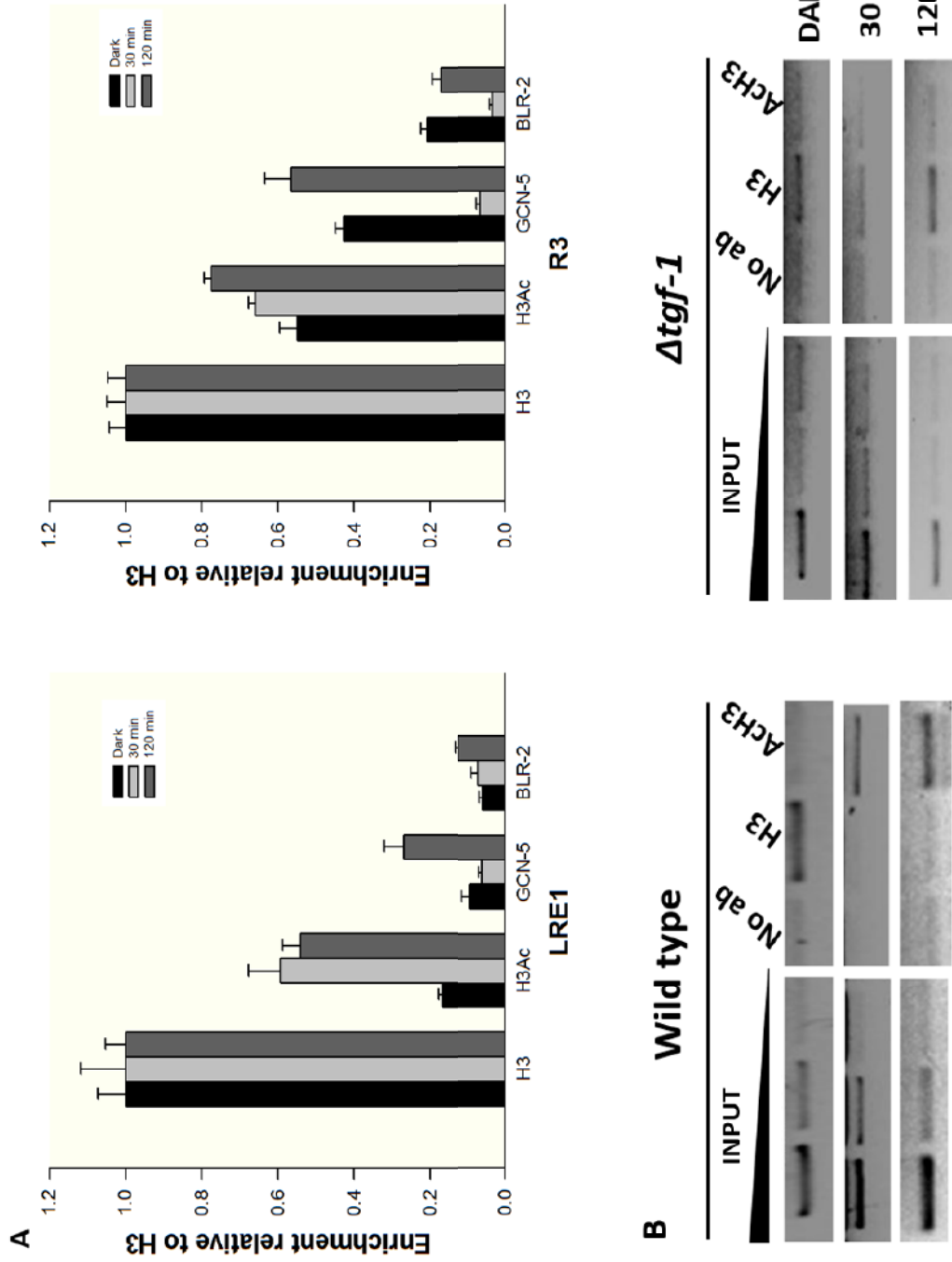

Table 1

Table 1 - Oligonucleotide primers used in this study

Primer name	Sequence (5'-3') ^{a, b}	Relevant characteristics
Δ tgf3'-F	<u>GGGGTACCC</u> CCCGTGGGATATGGCGAAGTGTA	PCR primers for amplification of the upstream <i>tgf-1</i> fragment
Δ tgf3'-R	CCCAAGCTTGGGACGGGAGACGCTGGTTGGAGAT	
Δ tgf3'-F	AAC <u>TGCAGCTGCA</u> TGGCCGTTCCTCG	PCR primers for amplification of the downstream <i>tgf-1</i> fragment
Δ tgf3'-R	<u>GCTCTAGAGTACT</u> TTTGTGTGCAATCGAG	
OEGCN5 Fw	<u>TCTAGAA</u> TGGCCGACATCAAAGAAG	PCR primers for amplification of <i>tgf-1</i> ORF gene
OEGCN5 Rv	<u>ATGCA</u> TCTATTTGTCCGGCTCGAG	
Id-mut-GCN5-Fw	TGTTGGCCAGCCCCCTATTG	PCR primers for identification of Δ <i>tgf-1</i> disruption mutants
Id-mut-hph-Fw	GATAGTGGAAACCGACGCCCC	
Ta-TEF-1-Fw	AGCCGAGCGTGAGCGTGGTAT	Quantitative real-time PCR primers for analysis of <i>tef-1</i> expression
Ta-TEF-1-Rv	ATGGGACGAAAGGCAACGGTCTT	
phr-1-Ta-Fw	TCATGTTGGATCAGCGAAGTCG	Quantitative real-time PCR primers for analysis of <i>phr-1</i> expression
phr-1-Ta-Rv	TACTCGGGCTTGAATGGCTTGT	
bid-2-Tr-Fw	ACAAAGTGGGTATCGAGGACTGIG	Quantitative real-time PCR primers for analysis of <i>bid-2</i> expression
bid-2-Tr-Rv	AGTTGGCGCACCATCATACTGACA	
grg-1-Ta-Fw	AGGGCGTGTCTCTGGTGCTA	Quantitative real-time PCR primers for analysis of <i>grg-1</i> expression
grg-1-Ta-Rv	CATCCTTGGCGGGTCCAG	
Ta-al-3-Fw	TTTCCGTGCCCAGCTCATCTCCTC	Quantitative real-time PCR primers for analysis of <i>al-3</i> expression
Ta-al-3-Rv	GCCACCCGTCTTATTCCTCCACCCAT	
env-1-Fw-PF	CCAAATTCATCCCGCCTGAC	Quantitative real-time PCR primers for analysis of <i>env-1</i> expression
env-1-Rv-PF	CCCTGATCCGGCTGTCTGGTTTG	
LRE1-PHR-Fw	TCATCCAGCTGATGGCTTATGC	PCR primers used in ChIP for amplification of <i>phr-1</i> promoter
LRE1-PHR-Rv	ATTCAGTGGCTTGGTATCCC	
Prom-TEF-Fw	CACCGTGATCATACCAGATCGCAG	PCR primers used in ChIP for amplification of <i>tef-1</i> promoter
Prom-TEF-Rv	TTTCTGCTGCACACCCCGCTA	

^a The respective restriction enzyme sites included in primers are indicated in bold letters

^b The additional bases added to primers in order to obtain an efficient digestion are indicated as underlined letters

Table 2

Table 2. Copy number of <i>hph</i> and <i>tgf-1</i> genes, calculated with the $2^{-\Delta\Delta Ct}$ method				
Copy number of <i>tgf-1</i> gene in Wild type and $\Delta tgf-1$ strain				
Strain	$\Delta Ct(Ct_{tgf-1}-Ct_{ref-1})$	$\Delta\Delta Ct^{ab}$	Copy number ($2^{-\Delta\Delta Ct}$)	S.D.^c
Wild type	0.347	0.000	1.00	0.10
$\Delta tgf-1$	11.405	11.058	0.00	0.00
Copy number of <i>hph</i> gene in $\Delta tgf-1$ strain, calculated with the $2^{-\Delta\Delta Ct}$ method				
Strain	$\Delta Ct(Ct_{hph}-Ct_{ref-1})$	$\Delta\Delta Ct^{ab}$	Copy number ($2^{-\Delta\Delta Ct}$)	S.D.^c
$\Delta tgf1$	-0.956	-0.174	1.128	0.019
^a $\Delta\Delta Ct = \Delta Ct_{sample} - \Delta Ct_{calibrator}$ ^b $\Delta blr-1$ was used as the calibrator strain ^c S.D. Standard deviation				

DISCUSIÓN

En *T. atroviride* la aplicación de un pulso de luz azul-UVA estimula la formación sincronizada en tiempo y espacio de un anillo de conidias verdes (fotoconidiación), que corresponde al perímetro de la colonia en crecimiento en el momento que fue aplicado el estímulo luminoso (Horwitz *et al.*, 1985). Durante las dos últimas décadas, algunos hongos integrantes de los géneros *Trichoderma/Hypocrea* han sido adoptados como modelos para el estudio molecular de la percepción de la señal luminosa, sin embargo, no se han realizado estudios sobre los mecanismos epigenéticos involucrados en la percepción de la luz.

En el presente trabajo reportamos la primera evidencia del papel que juega la acetilación de las histonas en la percepción de luz azul en *T. atroviride*. Los resultados del análisis global de la acetilación de la histona H3 (K9 y K14) después de un pulso de luz, mostraron una acetilación máxima a los 30 min. El TSA es un compuesto de origen bacteriano que funciona como un inhibidor de desacetilasas de histonas, el cual se ha determinado es capaz de provocar distintos efectos fenotípicos y cambios transcripcionales en varios organismos (Ikegami *et al.*, 1993; Grewal *et al.*, 1998). La aplicación del TSA al medio de cultivo, provocó un incremento en los niveles de acetilación en los tiempos y condiciones probados, aun en la oscuridad, comparado con las muestras sin tratar (Uresti-Rivera *et al.*, datos sin publicar). Los datos obtenidos indican que la acetilación de la histona H3 en los residuos K9 y/o K14 pueden ser una modificación clave en la regulación de la expresión génica en respuesta al estímulo luminoso. Decidimos entonces analizar el efecto del TSA en la expresión de algunos genes responsivos a luz azul. El efecto del TSA en la expresión de los genes *phr-1* y *bld-2* fue de una disminución de la expresión de ambos genes (Figura 5), efecto contrario a lo esperado, ya que generalmente un estado hiperacetilado se ha asociado con la activación transcripcional (Hong, 1993; Wolffe y Hayes, 1999). Este dato es interesante ya que existe un nivel global alto de proteína H3 acetilada. Una posible explicación a estos resultados sería que el TSA afecta de manera negativa a un activador de la

transcripción (e.g. *blr-1* o *blr-2*), o incluso la misma expresión del gen *tgf-1*, repercutiendo en una baja síntesis de la proteína TGF-1 y por lo tanto en la disminución de la transcripción de genes responsivos a la luz. La inhibición de las desacetilasas de histonas conlleva a la represión o activación transcripcional, y se cree que se genera un estado hiperacetilado directa o indirectamente en los promotores al existir una descompensación por el efecto del inhibidor entre el balance acetilación-desacetilación. La desregulación provocada por el TSA en estos genes puede ser muy compleja e implicar no únicamente a las histonas, ya que se ha visto que en *N. crassa* el TSA ocasiona una disminución en los niveles de metilación del ADN, que fue confirmado por la expresión de genes reporteros silenciados por este proceso (Selker, 1998). Otra probable explicación al efecto observado en la expresión de *phr-1* y *bld-2* son los elementos regulatorios en *cis* que poseen estos genes, ya que se ha comprobado que el gen *WT1* de ratón sufre una marcada reducción en su expresión después de un tratamiento con TSA y esta reducción es mediada por secuencias localizadas en el intrón 3 de este gen (Makki *et al.*, 2008). Por lo que no podemos descartar que la inhibición de las desacetilasas de las histonas en *T. atroviride* debido a la acción del TSA, haya provocado otras modificaciones en las histonas en ciertas regiones regulatorias de ambos genes que sirvan de “marcas” para disminuir la expresión transcripcional, e incluso debido a que los dos genes disminuyeron su expresión, suponemos que BLR se vio afectado a nivel transcripcional por el tratamiento con TSA, y éste se encarga de la regulación de los genes responsivos a luz.

Con el fin de tener un panorama más amplio de la participación de la acetilación y la transcripción en respuesta al estímulo luminoso, se aplicó un inhibidor específico de la acetil transferasa de histonas Gcn5p de *S. cerevisiae* (MC16269), y se analizó el fenotipo de conidiación de la cepa silvestre, así como el patrón de expresión de los genes *phr-1* y *bld-2*. Los datos mostraron que la aplicación del inhibidor MC16269, inhibió la conidiación después de haber aplicado un pulso de luz azul. Estos resultados indican que la acetilación de las histonas durante el proceso de fotoconidiación puede depender de TGF-1 en *T. atroviride* (Figura 6).

Adicionalmente, se determinó que un incremento de 500 veces en la concentración de MC1626, resultó en un fenotipo de crecimiento lento, lo que concuerda con el fenotipo observado en cepas de *S. cerevisiae* que carecen del gen *GCN5* (Howe *et al.*, 2001), lo cual indica la participación de *gcn5* en el desarrollo de ambos hongos. El hecho de que los transcritos de los genes *phr-1* y *bld-2* hayan disminuido en presencia de MC1626 sin que haya habido un cambio en la cinética de los mismos, nos lleva a suponer que TGF-1 es el coactivador de *phr-1* y que de alguna manera participa regulando la transcripción en la oscuridad de *bld-2*.

Para investigar si el estímulo luminoso induce la acetilación de la histona H3 en los promotores de los genes responsivos a la luz, se realizó un ChIP sobre la LRR ubicada en el promotor del gen *phr-1*. Los resultados mostraron que la histona H3 es acetilada en la LRR, siguiendo una cinética similar a la ya descrita para el transcrito de *phr-1*, y concuerda con lo reportado para el gen *al-3* de *N. crassa* (Grimaldi *et al.*, 2006). Estos datos nos indican que la acetilación de la histona H3 puede jugar un papel importante en la regulación de *phr-1* en respuesta al estímulo luminoso en *T. atroviride*.

Al realizar un análisis de secuencias de aminoácidos de las proteínas TGF-1, Gcn5p y NGF-1, se determinó que TGF-1 presenta un porcentaje global de identidad del 59% con Gcn5p y de un 85.3 % con NGF-1. La estructura predicha de la proteína TGF-1 mostró la presencia de un dominio catalítico de acetilación y un bromodominio al igual que sus homólogos Gcn5p y NGF-1. El dominio de acetilación de TGF-1 mostró un porcentaje de identidad de 77.8% con respecto a Gcn5p y de un 100% con NGF-1. En lo que respecta al bromodominio, TGF-1 presentó un porcentaje de identidad de 63.1% con Gcn5p y un 86.9% con NGF-1.

Tomando en consideración los datos anteriores, y aunado a que Gcn5 es la principal HAT que acetila la histona H3 en *S. cerevisiae* (Georgakopoulos y Thireos, 1992) y que NGF-1 es la responsable de acetilar la histona H3 en los promotores de genes responsivos a luz en *N. crassa*, y debido de que éste último presenta un mecanismo

similar de percepción de la señal luminosa con *T. atroviride*, se realizó el reemplazo génico de *tgf-1* por doble recombinación homóloga en *T. atroviride*.

La mutante generada Δ *tgf-1*, mostró un fenotipo pleiotrópico con un crecimiento muy lento y ausencia de conidiación. Estos resultados coincidieron con el fenotipo de la mutante Δ *ngf-1* la cual crece muy lento, produce pocas conidias y presenta un color rosa pálido del micelio después del pulso de luz (Grimaldi *et al.*, 2006). Este resultado indica la gran importancia que tiene TGF-1 en la fisiología y el desarrollo de *T. atroviride*. Este fenotipo puede ser explicado por el papel que juega esta Gcn5 en la regulación de genes y en las fases del ciclo celular en otros organismos. Por ejemplo, se ha reportado que en *A. thaliana* una mutante que carece del gen *gcn5* (*gcn5-1*) muestra una disminución en la inflorescencia, plantas enanas y las últimas flores presentan pequeñas silicuas que contienen muy pocas semillas. Cabe resaltar que en esta mutante se encontró una disminución de la expresión de genes implicados en el desarrollo y en la división celular como la actina (ACT 11) y una ciclina (cyclin delta-1) (Vlachonasios *et al.*, 2003). En *S. cerevisiae* la ausencia del gen *GCN5* mostró que las células se detienen en la fase G2/M, indicando la importancia de Gcn5p para la progresión normal del ciclo celular (Zhang *et al.*, 1998). Recientemente se reportó que la mutante en *gcn5* del hongo *Cryptococcus neoformans* (*gcn5* Δ), presentó una disminución en la transcripción del gen *Kre61*, el cual está involucrado en la biosíntesis de la pared celular y la arquitectura de la cápsula. También presentó una baja expresión de genes que codifican para glucano sintetas y del gen *Tor1*, que codifica para una calcineurina (O' Meara *et al.*, 2010). La ruta de la calcineurina activa la transcripción de los genes necesarios para el crecimiento a altas temperaturas (Kraus *et al.*, 2005). En *S. cerevisiae* se demostró que Gcn5p es la principal responsable de acetilar el residuo de lisina 25 (K25) de la proteína remodeladora *Rsc4*, y que la mutación en este conllevaba a la no acetilación del residuo K25 de *Rsc4*, lo que generó defectos en el crecimiento (VanDemark *et al.*, 2007).

Para investigar la participación de TGF-1 en la regulación de genes responsivos a la luz azul, se analizó la expresión de estos genes en respuesta a la luz azul (*phr-1*, *bld-2*, *grg-1*, *al-3* y *envoy*) en la cepa Δ *tgf-1* y se comparó con la cepa silvestre. La expresión de los genes inducidos por la luz se vio significativamente disminuida. Aunque se observó una reducción en el transcrito de *phr-1* y *grg-1*, la cinética de expresión permaneció. Para el gen *bld-2* se observaron cantidades muy bajas de transcrito en comparación con la cepa silvestre donde su expresión en oscuridad se encuentra elevada (Rosales- Saavedra *et al.*, 2004). El hecho de que TGF-1 sea necesario para la expresión de *bld-2* en la oscuridad, nos habla de su papel en la regulación positiva de este gen bajo estas condiciones, así como de la interacción que pudiera tener con el complejo BLR ya que se ha visto que la proteína BLR-2 se encuentra posicionada en la oscuridad sobre el promotor del gen *phr-1* (Cervantes-Badillo *et al.*, 2013). Brenna *et al.* (2012) demostraron la presencia conjunta de WC-1 y NGF-1 en la oscuridad, lo que nos lleva a proponer que para el caso de la regulación de *bld-2* en condiciones de oscuridad, el complejo formado por las proteínas BLR-TGF-1 se encuentra en forma basal y activa su transcripción. Para el caso del gen *al-3* el cual codifica para una geranil geranil pirofosfatsa sintasa (GGPS) y que presenta una alta similitud al gen *al-3* de *N. crassa*, presentó una expresión constitutiva y los niveles del transcrito fueron ligeramente más elevados en oscuridad comparados con la cepa silvestre. Estos resultados son similares a los observados para el gen *al-3* en la mutante NGF-1 de *N. crassa* (Grimaldi *et al.*, 2006). La GGPS está involucrada en el primer paso de la síntesis de carotenoides (Carattoli *et al.*, 1991), si bien en *T. atroviride* no se observa un acumulación de pigmentos en el micelio después de una exposición a la luz azul, el gen homólogo a *al-3* podría estar involucrado en la síntesis de metabolitos secundarios (Glomset *et al.*, 1990), por lo tanto no es de asombrarse el fenotipo observado en Δ *tgf-1*. Por otra parte en *A. thaliana* la mutante *gcn5-1* despliega un fenotipo de hojas cloróticas, especialmente bajo iluminación constante (Vlachonasios *et al.*, 2003), lo que confirma la importancia de la participación de *gcn5* en la producción de pigmentos. El gen *env1* (homólogo a *vvd* de *N. crassa*) que codifica para un presunto fotorreceptor secundario de la luz azul, el cual participa en la fotoadaptación

(Schmoll *et al.*, 2005), no se indujo al aplicar el pulso de luz azul, comparado con la cepa silvestre. Cabe resaltar que *vvd* en *N. crassa*, no se induce en el fondo genético $\Delta ngf-1$, lo que nos lleva a concluir que TGF-1 y NGF-1 son coactivadores que participan en la respuesta a la luz azul en estos hongos, y que la regulación que tienen sobre los genes de respuesta a la luz es similar. Además, estos resultados indican que TGF-1 es necesario para la actividad transcripcional de *bld-2* en la oscuridad, hecho que coincide con el papel de estas HATs en promover una cromatina abierta para el acceso a la maquinaria transcripcional como se ha demostrado en otros sistemas. Estos datos en conjunto indican que TGF-1 regula de diferente manera a los genes responsivos a la luz analizados en el presente trabajo y que esto puede implicar la participación de más elementos regulatorios además de las proteínas BLR.

Los resultados de acetilación global obtenidos para la cepa $\Delta tgf-1$, mostraron niveles muy elevados de acetilación de la histona H3 en la oscuridad y en los tiempos analizados después del pulso de luz azul, comparados con la cepa silvestre. Estos datos sugieren la activación de otras HAT reguladas negativamente por TGF-1, o bien, que podrían participar en este fondo genético algunas de las 8 HAT identificadas en el genoma de *Trichoderma* para compensar la ausencia de TGF-1 (Uresti-Rivera y Casas-Flores, sin publicar). Evidencias que apoyan esta hipótesis ya han sido reportadas, por ejemplo, en *A. thaliana* se observó que en el fondo mutante *gcn5-1*, la expresión de un gen que codifica para la una acetil transferasa de histonas relacionada a CBP, denominada pCAT1 se vio incrementada (Vlachonasios *et al.*, 2003). Adicionalmente en *S. cerevisiae* se observó que una mutante en el gen *GCN5* seguía presentando acetilación en los residuos de lisinas 9 y 14 de la región amino terminal de la histona H3 casi comparable al de la cepa silvestre. La HAT responsable de esta acetilación es la Sas3, ya que una doble mutante condicional (ya que la mutación en ambos genes es letal) *gcn5 Δ sas3 Δ* resultó en un decremento casi total de la acetilación de la región amino terminal de la histona H3. Esta disminución en la acetilación no se observó en una mutante en la HAT Esa1. Lo que demostró que Sas3 es responsable de al menos una porción

de la acetilación global *in vivo* de la histona H3 (Howe *et al.*, 2001). A pesar de los altos niveles de acetilación a nivel global en la histona H3 en la cepa $\Delta tgf-1$, esto no se observó en el promotor de *phr-1* comparado con la cepa silvestre, lo cual indica una especificidad de TGF-1 sobre *phr-1* (y probablemente en el resto de los promotores de los genes inducibles por la luz) en respuesta a la luz azul en *T. atroviride*.

Los receptores nucleares (NR) de los vertebrados llevan a cabo procesos de regulación similares a los que realizan las proteínas WC-1, ya que interactúan con proteínas remodeladoras de la cromatina para llevar a cabo su actividad transcripcional (Green y Han, 2011). En los vertebrados, diversos NRs y coactivadores presentan un motivo de leucina-X-X-leucina-leucina (LXXLL) donde X puede ser cualquier aminoácido. Este motivo conocido como la caja NR, es responsable de la interacción de factores transcripcionales con diversos coactivadores (Savkur y Burris, 2004; Jiang *et al.*, 2010). Recientemente, se demostró que la interacción física entre NGF-1 y WC-1, es esencial para que se lleve a cabo la transducción de la señal luminosa en *N. crassa* y que ésta interacción está mediada por el motivo LXXLL, presente en la región amino terminal de la proteína WC-1 (Brenna *et al.*, 2012). Es posible que estas dos proteínas pudieran interactuar a través del motivo LXXLL presente en BLR-1 de *T. atroviride*. La actividad dual que ejercen las proteínas BLR tanto en la activación como en la represión de la transcripción, sugiere que el complejo BLR, podría estar interactuando con más proteínas reguladoras como co-activadores y co-represores encargados de llevar a cabo las modificaciones químicas de las histonas llevando a un estado abierto o cerrado de la cromatina respectivamente. Esta hipótesis se apoya por el hecho de que en *N. crassa* el complejo WCC después de un pulso de luz (L-WCC) es de mayor peso molecular que el que se observa en la oscuridad (D-WCC) (He y Liu, 2005). Esto se puede deber probablemente a la multimerización de las proteínas WC y la presencia de factores adicionales, como NGF-1.

En el presente trabajo observamos que la percepción de la luz azul en *T. atroviride* está regulada por procesos epigenéticos. Se demostró la relevancia de la acetilación de los residuos de las lisinas (K9 y/o K14) en las colas amino terminales de las histonas H3 que se encuentran en el promotor de *phr-1*. La acetilación está mediada por la proteína TGF-1, la cual es importante para *Trichoderma* en el crecimiento y la formación de conidias. Además, sugerimos que es necesaria la participación conjunta de TGF-1 y la proteína BLR-1 para que se lleve a cabo la transducción de la señal, y la transcripción apropiada de los genes responsivos a la luz azul. Estudios adicionales se requieren sobre otras modificaciones de las histonas como metilación o fosforilación, para determinar si estas modificaciones están presentes en los promotores de genes regulados por luz. También se requiere determinar si otros co-activadores y co-represores están interaccionando con el complejo BLR. Esto nos ayudará a comprender los mecanismos moleculares de percepción de la luz azul en *T. atroviride*.

CONCLUSIONES

- El gen *tgf-1* es necesario para el crecimiento, el desarrollo apropiado y para la morfogénesis en *T. atroviride*.
- El gen *tgf-1* es necesario para la co-activación transcripcional de los genes de respuesta a la luz azul.
- El gen *tgf-1* es necesario para la actividad transcripcional de *bld-2* en la oscuridad.
- La proteína TGF-1 es la responsable de la acetilación inducida por luz azul en el promotor del gen *phr-1*.

PERSPECTIVAS

Los resultados obtenidos en este trabajo nos permitieron identificar a TGF-1 como un coactivador transcripcional que participa en la regulación epigenética de los genes de respuesta a la luz azul en *T. atroviride*. Sin embargo, aún queda mucho trabajo por realizar para dilucidar a profundidad el papel que esta proteína juega en la transducción de la señal luminosa. Los objetivos a corto y largo plazo que se proponen alcanzar para entender los mecanismos moleculares derivados de la acción de TGF-1 son:

- Analizar el patrón de la acetilación de la histona H3 en los promotores de otros genes responsivos a la luz azul en los fondos genéticos silvestre y Δ *tgf-1*, con el fin de comprobar si TGF-1 es el responsable de la acetilación de los genes responsivos a la luz azul.
- Comprobar la interacción de TGF-1 con la proteína BLR1, con un ensayo de co-inmunoprecipitación de proteínas o con un ensayo de complementación bimolecular.
- Analizar la presencia conjunta de estas dos proteínas en condiciones de luz y oscuridad.
- Determinar la actividad de acetil transferasa de histonas de la proteína TGF-1 en condiciones de luz y oscuridad en la cepa silvestre.
- Determinar por mutagénesis dirigida si el dominio conservado LXXLL presente en la proteína BLR-1 es importantes para la unión con TGF-1 y por tanto la repercusión que tenga en la acetilación de las histonas de los promotores de genes regulados por la luz azul.

ANEXOS

1. Oligonucleótidos utilizados

1. Lista de oligonucleótidos utilizados en el presente trabajo		
Nombre	Secuencia (5' a 3') ^a	Gen blanco
Oligos para la generación e identificación de la mutante <i>Δtgf-1</i>		
GCN5 amino Fw	GGGGTACCC CCCGTGGGATATGGCGAAGTGTA	Promotor <i>gcn5</i>
GCN5 amino Rv	CCC AAGCTT GGGACGGGAGACGCTGGTTGGAGAT	
GCN5 carboxilo Fw	AACTGCAG CTGCATGGCCGTTCCCTCG	Terminador <i>gcn5</i>
GCN5 carboxilo Rv	GCTCTAGAG TACTTTGTGTGCAATCGAG	
OEGCN5 Fw	TCTAGA ATGGCCGACATCAAAGAAG	ORF <i>gcn5</i>
OEGCN5 Rv	ATGCAT CTATTTGTCCGGCTCGAG	
ld-mut-GCN5-Fw	TGTTGGCCAGCCCCCTATTTG	Promotor <i>gcn5</i>
		Gen hph (979-999 con respecto al ATG)
ld-mut-hph-Fw	GATAGTGGAACCGACGCCCC	
Oligos para análisis transcripcional		
Ta-TEF-1-Fw	AGGCCGAGCGTGAGCGTGGTAT	<i>tef-1</i>
Ta-TEF-1-Rv	ATGGGGACGAAGGCAACGGTCTT	
actin-Ta-Fw	TCACCGAGGCCCCCATCAACC	<i>actina</i>
actin-Ta-Rv	CGACCGGAAGCGTACAGGGACAGA	
phr-1-Ta-Fw	TCATGTTTGGATCAGCGAAGTCG	<i>phr-1</i>
phr-1-Ta-Rv	TACTCGGGCTTGAATGGCTTGTT	
bld-2-Ta-Fw	ACAAGTGCGGTATCGAGGACTGTG	<i>bld-2</i>
bld-2-Ta-Rv	AGTTGGCGCACCATCATACTGACA	
bld-2-Tr-Fw	ACAAGTGCGGTATCGAGGACTGTG	<i>bld-2</i>
bld-2-Tr-Rv	AGTTGGCGCACCATCATACTGACA	
grg-1-Ta-Fw	AGGGCGCTGTCTCTGGTGCTA	<i>grg-1</i>
grg-1-Ta-Rv	CATCCTTGGCGGCGGTCAG	
Ta-al-3-Fw	TTTCCGTGCCAGCTCATCTCCTC	<i>al-3</i>
Ta-al-3-Rv	GCCACCCGTCTTATTCACCACCAT	
ENVOY-Fw-PF	CCAATTTCCATCCCCGCCTGAC	<i>envoy</i>
ENVOY-Rv-PF	CCCTGATCCGGCTGTCTGGTTTG	
Oligos para análisis por ChIP		
LRE1-PHR-Fw	TCATCCAGCTGATGGCTTATGC	Promotor <i>phr-1</i>
LRE1-PHR-Rv	ATTTCAAGTGGCTTGGTATCCC	
Prom-TEF-Fw	CACCGTGATCATACCAGATCGCAG	Promotor <i>tef-1</i>
Prom-TEF-Rv	TTTCTGCTGCACACCCGCTA	

^a La secuencia de nucleótidos en negrita representa sitios de restricción adicionados y la región subrayada a las bases adicionadas para un corte más eficiente de la enzima de restricción.

2. Anticuerpos utilizados

2. Lista de anticuerpos utilizados en este estudio		
Antigenicidad	Características/Aplicación/Referencia	Casa comercial
Región amino de la Histona H3	Anticuerpo monoclonal/ChIP/ ab1791	Abcam
Región completa amino acetilado de la Histona H3	Anticuerpo policlonal/ChiP/WB/ 06-599	Millipore
Gcn5p (aa 1-300)	Anticuerpo policlonal/WB/IP/ sc-9078	Santa Cruz Bio-Synthesis Inc.
BLR-2 (aa 297-315)	Anticuerpo policlonal	

3. Ensayo de fotoinducción para la cepa $\Delta tgf-1$

Con ayuda de un sacabocados y a partir de una colonia de la cepa $\Delta tgf-1$ de 4-5 días de crecimiento en PDA a 28 °C, se realizó un pre-inóculo colocando varios discos de esta colonia en medio PDB, bajo luz roja de seguridad. El cultivo se creció 48 h a 28 °C en la oscuridad. Transcurrido este tiempo, se vertió un poco de este cultivo sobre cajas de Petri conteniendo PDA cubierto con un disco de papel celofán. Posteriormente, las colonias fueron fotoinducidas de igual manera que la cepa silvestre, exponiéndolas durante 5 min a una fuente de luz azul, con una intensidad de 1200 $\mu\text{mol}/\text{m}^2$ proveniente de un dispositivo que contiene dos lámparas fluorescentes de luz blanca fría y un filtro azul de acrílico (LEE #183; con una intensidad de 3 $\mu\text{mol}/\text{m}^2\text{s}^{-1}$). El micelio fue colectado con ayuda de un bisturí bajo luz roja de seguridad (filtro LEE #106; con una intensidad de 0.1 $\mu\text{mol}/\text{m}^2\text{s}^{-1}$) a diferentes tiempos después del pulso de luz (30 y 120 min), e inmediatamente congelado en nitrógeno líquido para posteriormente extraer el RNA total y analizar la expresión de los genes regulados por la luz azul.

4. Ensayo de Inmunoprecipitación de la cromatina (ChIP)

Para realizar los ensayos de Inmunoprecipitación de la cromatina, bajo luz roja de seguridad, se tomó micelio crecido de colonias de las cepas silvestre y $\Delta tgf-1$ de *T. atroviride* de cada condición proveniente de 2 cajas Petri, y se fijó en 10 ml buffer de crosslinking (50mM Hepes pH 7.4; 137mM KCl; 1mM EDTA) con formaldehído a una concentración final de 1% durante 15 min a temperatura ambiente en agitación. Después de este tiempo se añadió glicina a una concentración final de 125 mM para parar la reacción. El micelio se lavó 3 veces con PBS frío, se filtró y se trituró en nitrógeno líquido. Posteriormente se adicionaron 1000 μ L de buffer de lisis al micelio molido (1% SDS, 10mM EDTA pH 8.0, 50mM Tris-HCl pH 8.1), con inhibidor de proteasas (12,5 μ l de inhibidor de proteasa por muestra). Las muestras se sonicaron en 12 ciclos de 30 segundos a una 7 $\frac{1}{2}$ partes de potencia del sonicador. Posteriormente, se centrifugó el extracto a 13000 rpm durante 10 min a 4 °C, y se recuperaron los sobrenadantes. De estos se tomaron 20 μ l de cada uno y se corrieron en un gel de agarosa con el fin de comprobar que se hayan obtenido fragmentos de cromatina de entre 300-700 pares de bases. Otros 20 μ l se tomaron y se incubaron con RNAsa y Proteinasa K y posteriormente se purificaron (como se describe más adelante) y se cuantificaron a fin de añadir cantidades iguales de cromatina para cada IP. Del sobrenadante se tomaron 10 μ l y se transfirieron a un tubo nuevo, el cual se almacenó para utilizarlo posteriormente como el total o input. La cromatina se incubó durante 2 horas a 4°C con 30 μ L de Dynabeads (Invitrogen). Transcurrido este tiempo se retiraron los Dynabeads mediante un magneto y se agregó a la cromatina buffer de dilución (1/10) (1% Triton X-100, 2mM EDTA pH 8.0, 150mM NaCl, 20mM Tris-HCl pH 8.1), y se incubaron con los anticuerpos específicos (5 μ L de anti-AcH3, 2.5 μ l de anti-H3, 25 μ l de anti-gcn5 y 5 μ l de anti-BLR-2) durante toda la noche a 4°C en agitación suave. Los complejos formados se precipitaron al añadir 25 μ L de Dynabeads y se continuó con la incubación durante 2 horas. Posteriormente se lavaron los complejos al añadir secuencialmente los siguientes buffers, se invirtieron repetidamente los tubos, y se colocaron en el magneto para remover los buffers. Se realizaron 2 lavados con 1 ml de solución de lavado I (0.1% SDS, 1% Tritón x-100, 2mM EDTA, 20mM Tris-Hcl pH 8.1, 150mM

NaCl), seguido de 1 lavado con 1 ml solución de lavado II (0.1% SDS, 1% Tritón x-100, 2mM EDTA, 20mM Tris-Hcl pH 8.1, 500mM NaCl). Enseguida se realizaron 2 lavados con 1 ml solución de lavado III (0.25M LiCl, 1% NP40, 1% Deoxicolato, 1mM EDTA, 10mM Tris-Hcl pH8.1), y finalmente 1 lavado con 1 ml de buffer TE (20 mM Tris-HCl, 2 mM EDTA). A continuación los complejos se eluyeron al añadir 100 μ l de buffer de elución (1% SDS, 0.1M NaHCO₃), RNAsa y Proteinasa K a una concentración final de 500mg/ml. Por último con la finalidad de revertir el crooslink las muestras se incubaron a 65°C durante toda la noche (También los inputs o totales). La cromatina fue purificada mediante el kit de extracción Wizard® SV Gel and PCR Clean-Up System (Promega). Los fragmentos se analizaron mediante PCR tiempo real.

PARTICIPACIÓN EN OTROS TRABAJOS

Colonization of Arabidopsis roots by *Trichoderma atroviride* promotes growth and enhances systemic disease resistance through jasmonic acid/ethylene and salicylic acid pathways

Miguel Angel Salas-Marina & Miguel Angel Silva-Flores &
Edith Elena Uresti-Rivera & Ernestina Castro-Longoria &
Alfredo Herrera-Estrella & Sergio Casas-Flores

Accepted: 30 March 2011 / Published online: 27 April 2011
KNPV 2011

Abstract *Trichoderma* spp. are common soil fungi used as biocontrol agents due to their capacity to produce antibiotics, induce systemic resistance in plants and parasitize phytopathogenic fungi of major agricultural importance. The present study investigated whether colonization of *Arabidopsis thaliana* seedlings by *Trichoderma atroviride* affected plant growth and development. Here it is shown that *T. atroviride* promotes growth in *Arabidopsis*. Moreover, *T. atroviride* produced indole compounds in liquid cultures. These results suggest that indole-

acetic acid-related indoles (IAA-related indoles) produced by *T. atroviride* may have a stimulatory effect on plant growth. In addition, whether colonization of *Arabidopsis* roots by *T. atroviride* can induce systemic protection against foliar pathogens was tested. *Arabidopsis* roots inoculation with *T. atroviride* provided systemic protection to the leaves inoculated with bacterial and fungal pathogens. To investigate the possible pathway involved in the systemic resistance induced by *T. atroviride*, the expression profile of salicylic acid, jasmonic acid/ethylene, oxidative burst and camalexin related genes was assessed in *Arabidopsis*. *T. atroviride* induced an overlapped expression of defence-related genes of SA and JA/ET pathways, and of the gene involved in the synthesis of the antimicrobial phytoalexin, camalexin, both locally and systemically. This is the first report where colonization of *Arabidopsis* roots by *T. atroviride* induces the expression of SA and JA/ET pathways simultaneously to confer resistance against hemibiotrophic and necrotrophic phytopathogens. The beneficial effects induced by the inoculation of *Arabidopsis* roots with *T. atroviride* and the induction of the plant defence system suggest a molecular dialogue between these organisms.

Keywords Plant–fungus interaction · Systemic resistance · Camalexin · PR proteins

Miguel Angel Salas-Marina and Miguel Angel Silva-Flores contributed equally to this work.

M. A. Salas-Marina · M. A. Silva-Flores ·
E. E. Uresti-Rivera · S. Casas-Flores (*^{*})
División de Biología Molecular, Instituto Potosino de
Investigación Científica y Tecnológica,
Camino a la Presa San Jose No. 2055, Col.,
Lomas 4a Sección,
San Luis Potosí, SLP 78216, Mexico
e-mail: scasas@ipicyt.edu.mx

E. Castro-Longoria
Departamento de Microbiología, Centro de Investigación
Científica y de Educación Superior de Ensenada,
Ensenada, Baja California, Mexico

A. Herrera-Estrella
Laboratorio Nacional de Genómica para la Biodiversidad,
Km. 9.6 Libramiento Norte Carr. Irapuato-León 36821,
Irapuato, Gto, Mexico

RESEARCH

Open Access

Comparative genome sequence analysis underscores mycoparasitism as the ancestral life style of *Trichoderma*

Christian P Kubicek^{1*}, Alfredo Herrera-Estrella², Verena Seidl-Seiboth¹, Diego A Martinez³, Irina S Druzhinina¹, Michael Thon⁴, Susanne Zeilinger¹, Sergio Casas-Flores⁵, Benjamin A Horwitz⁶, Prasun K Mukherjee⁷, Mala Mukherjee⁶, László Kredics⁸, Luis D Alcaraz², Andrea Aerts⁹, Zsuzsanna Antal⁸, Lea Atanasova¹, Mayte G Cervantes-Badillo⁵, Jean Challacombe⁹, Olga Chertkov⁹, Kevin McCluskey¹⁰, Fanny Coudrier¹¹, Nandan Deshpande¹², Hans von Döhren¹³, Daniel J Ebbold¹⁴, Edgardo U Esquivel-Naranjo², Erzsébet Fekete¹⁵, Michel Flippin¹⁶, Fabian Glaser⁶, Elida Y Gómez-Rodríguez⁵, Sabine Gruber¹, Cliff Han⁹, Bernard Henrissat¹⁷, Rosa Hermosa⁴, Miguel Hernández-Oñate², Levente Karaffa¹⁵, Idit Kosti⁶, Stéphane Le Crom¹¹, Erika Lindquist⁹, Susan Lucas⁹, Mette Lübeck¹⁸, Peter S Lübeck¹⁸, Antoine Margeot¹⁹, Benjamin Metz¹, Monica Misra⁹, Helena Nevalainen¹², Markus Omann¹, Nicolle Packer¹², Giancarlo Perrone²⁰, Edith E Uresti-Rivera⁵, Asaf Salamov⁹, Monika Schmoll¹, Bernhard Seiboth¹, Harris Shapiro⁹, Serenella Sukno⁴, Juan Antonio Tamayo-Ramos²¹, Doris Tisch¹, Aric Wiest¹⁰, Heather H Wilkinson¹⁴, Michael Zhang⁹, Pedro M Coutinho¹⁷, Charles M Kenerley¹⁴, Enrique Monte⁴, Scott E Baker^{9,22} and Igor V Grigoriev⁹

Abstract

Background: Mycoparasitism, a lifestyle where one fungus is parasitic on another fungus, has special relevance when the prey is a plant pathogen, providing a strategy for biological control of pests for plant protection. Probably, the most studied biocontrol agents are species of the genus *Hypocrea*/*Trichoderma*.

Results: Here we report an analysis of the genome sequences of the two biocontrol species *Trichoderma atroviride* (teleomorph *Hypocrea atroviridis*) and *Trichoderma virens* (formerly *Gliocladium virens*, teleomorph *Hypocrea virens*), and a comparison with *Trichoderma reesei* (teleomorph *Hypocrea jecorina*). These three *Trichoderma* species display a remarkable conservation of gene order (78 to 96%), and a lack of active mobile elements probably due to repeat-induced point mutation. Several gene families are expanded in the two mycoparasitic species relative to *T. reesei* or other ascomycetes, and are overrepresented in non-syntenic genome regions. A phylogenetic analysis shows that *T. reesei* and *T. virens* are derived relative to *T. atroviride*. The mycoparasitism-specific genes thus arose in a common *Trichoderma* ancestor but were subsequently lost in *T. reesei*.

Conclusions: The data offer a better understanding of mycoparasitism, and thus enforce the development of improved biocontrol strains for efficient and environmentally friendly protection of plants.

* Correspondence: ckubicek@mail.zserv.tuwien.ac.at

¹Area Gene Technology and Applied Biochemistry, Institute of Chemical Engineering Vienna University of Technology, Getreidemarkt 9, 1060 Vienna, Austria

Full list of author information is available at the end of the article



Background

Mycoparasitism is the phenomenon whereby one fungus is parasitic on another fungus, a lifestyle that can be dated to at least 400 million years ago by fossil evidence [1]. This has special relevance when the prey is a plant pathogen, providing a strategy for biological control of pests for plant protection ('biocontrol'). The movement toward environmentally friendly agricultural practices over the past two decades has thus accelerated research in the use of biocontrol fungi [2]. Probably the most studied biocontrol agents are species of the genus *Hypocrea*/*Trichoderma*, *Trichoderma atroviride* (Ta) and *Trichoderma virens* (Tv) - teleomorphs *Hypocrea atroviridis* and *Hypocrea virens*, respectively - being among the best mycoparasitic biocontrol agents used in agriculture [3]. The beneficial effects of *Trichoderma* spp. on plants comprise traits such as the ability to antagonize soil-borne pathogens by a combination of enzymatic lysis, secretion of antibiotics, and competition for space and substrates [4,5]. In addition, it is now known that some *Trichoderma* biocontrol strains also interact intimately with plant roots, colonizing the outer epidermis layers, and acting as opportunistic, avirulent plant symbionts [6].

Science-based improvement of biocontrol agents for agricultural applications requires an understanding of the biological principles of their actions. So far, some of the molecular aspects - such as the regulation and role of cell wall hydrolytic enzymes and antagonistic secondary metabolites - have been studied in *Trichoderma* [3-5]. More comprehensive analyses (for example, by the use of subtractive hybridization techniques, proteomics or EST approaches) have also been performed with different *Trichoderma* species, but the interpretation of the data obtained is complicated by the lack of genome sequence information for the species used (reviewed in [7]).

Recently, the genome of another *Trichoderma*, *Trichoderma reesei* (Tr, teleomorph *H. jecorina*), which has a saprotrophic lifestyle and is an industrial producer of plant biomass hydrolyzing enzymes, has been sequenced and analyzed [8]. Here we report the genome sequencing and comparative analysis of two widely used biocontrol species of *Trichoderma*, that is, Ta and Tv. These two were chosen because they are distantly related to Tr [9] and represent well defined phylogenetic species [10,11], in contrast to *Trichoderma harzianum* sensu lato, which is also commonly used in biocontrol but constitutes a complex of several cryptic species [12].

Results

Properties of the *T. atroviride* and *T. virens* genomes

The genomes of Ta IMI 206040 and Tv Gv29-8 were sequenced using a whole genome shotgun approach to approximately eight-fold coverage and further improved using finishing reactions and gap closing. Their genome sizes were 36.1 (Ta) and 38.8 Mbp (Tv), and thus larger than the 34 Mbp determined for the genome of Tr [8]. Gene modeling, using a combination of homology and ab initio methods, yielded 11,865 gene models for Ta and 12,428 gene models for Tv, respectively (Table 1), both greater than the estimate for Tr (9,143). As shown in Figure 1, the vast majority of the genes (7,915) occur in all three *Trichoderma* species. Yet Tv and Ta contain about 2,756 and 2,510 genes, respectively, that have no true orthologue in any of the other species, whereas Tr has only 577 unique genes. Tv and Ta share 1,273 orthologues that are not present in Tr, which could thus be part of the factors that make Ta and Tv mycoparasites (for analysis, see below).

With respect to other ascomycetes, Tr, Ta and Tv share 6,306/7,091, 6,515/7,549, and 6,564/7,733 orthologues with *N. crassa* and *Gibberella zeae*, respectively.

Table 1 Genome assembly and annotation statistics

	<i>T. atroviride</i>	<i>T. virens</i>	<i>T. reesei</i>
Genome size, Mbp	36.1	38.8	34.1
Coverage	8.26x	8.05x	9.00x
Assembly gaps, Mbp	0.1 (0.16%)	0.2(0.4%)	0.05 (0.1%)
Number of scaffolds	50	135	89
Number of predicted genes	11865	12518	9143
Gene length, bp	1747.06	1710.05	1793.25
Protein length, amino acids	471.54	478.69	492.27
Exons per gene	2.93	2.98	3.06
Exon length, bp	528.17	506.13	507.81
Intron length, bp	104.20	104.95	119.64
Supported by homology, NR	10,219 (92%)	10,915 (94%)	8409 (92%)
Supported by homology, Swissprot	8,367(75%)	8,773 (75%)	6763 (74%)
Has PFAM domain	5,883 (53%)	6,267 (54%)	5096 (56%)

NR, non-redundant database; PFAM, protein families.

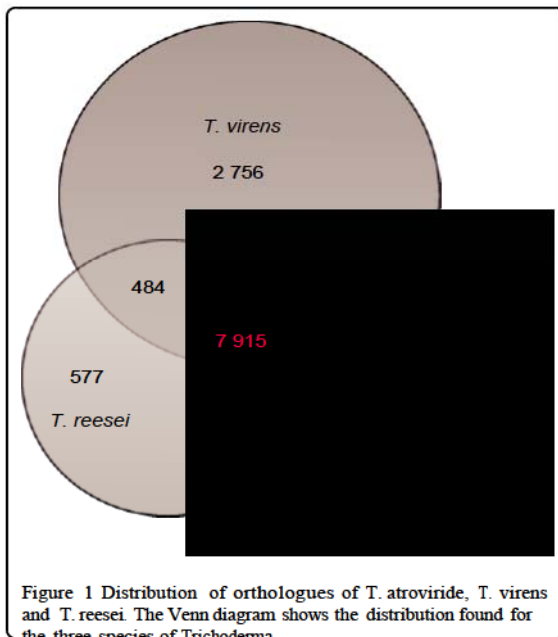

Figure 1 Distribution of orthologues of *T. atroviride*, *T. virens* and *T. reesei*. The Venn diagram shows the distribution found for the three species of *Trichoderma*.

Thus, approximately a third of the genes in the three *Trichoderma* species are not shared in even the relatively close relative *G. zeae* and are thus unique to *Trichoderma*.

Genome synteny

A comparison of the genomic organization of genes in *Ta*, *Tv* and *Tr* showed that most genes are in synteny: only 367 (4%) genes of *Tr*, but 2,515 (22%) of genes of *Tv* and 2,690 (21%) genes of *Ta* are located in non-

Table 2 Occurrence of orthologues, paralogues and singletons in the genomes of the three *Trichoderma* spp

Genome	Synteny	Total genes	Orthologs ^a	Non-orthologs	p-value ^b
<i>T. atroviride</i>	Syntenic	9,350	7,326	2,024	2.2e-16
	Non-syntenic	2,515	1,265	1,250	
<i>T. virens</i>	Syntenic	9,828	7,326	2,502	2.2e-16
	Non-syntenic	2,690	1,532	1,158	
<i>T. reesei</i>	Syntenic	8,776	7,326	1,450	2.2e-16
	Non-syntenic	367	153	214	

^aOrthologs that are in all three genomes. ^bNull hypothesis that the proportion of non-orthologs that are syntenic is less than the proportion of non-

syntenic regions (identified as a break in synteny by a series of three or more genes (Table 2); a global visual survey can be obtained at the genome websites of the three *Trichoderma* species (see Materials and methods) by clicking 'Synteny' and 'Dot Plot'). As observed for other fungal genomes [13-15], extensive rearrangements have occurred since the separation of these three fungi but with the prevalence of small inversions [16]. The numbers of the synteny blocks increased with their decreased size, compatible with the random breakage model [14] as in aspergilli [15,17]. Sequence identity between syntenic orthologs was 70% (*Tr* versus *Ta*), 78% (*Tr* versus *Tv*), and 74% (*Tv* versus *Ta*), values that are similar to those calculated for aspergilli (for example, *Aspergillus fumigatus* versus *Aspergillus niger* (69%) and versus *Aspergillus nidulans* (68%) and comparable to those between fish and man [17,18].

Transposons

A scan of the genome sequences with the de novo repeat finding program 'Piler' [19] - which can detect repetitive elements that are at least 400 bp in length, have more than 92% identity and are present in at least three copies - was unsuccessful at detecting repetitive elements. The lack of repetitive elements detected in this analysis is unusual in filamentous fungi and suggests that, like the *Tr* genome [8], but unlike most other filamentous fungi, the *Ta* and *Tv* genomes lack a significant repetitive DNA component.

Because of the paucity of transposable elements (TEs) in the *Trichoderma* genomes, we wondered whether simple sequence repeats and minisatellite sequences may also be rare. To this end, we surveyed the genomes of the *Trichoderma* species using the program Tandem Repeat Finder [20]. We also included the genomes of three additional members of the Sordariomycetes and one of the Eurotiomycetes as reference (Table S1 in Additional file 1). Satellite DNA content varied from as little as 2,371 loci (0.53% of the genome) in *A. nidulans*

to 9,893 (1.46% of the genome) in *Neurospora crassa*. Satellite DNA content of the *Trichoderma* genomes ran-

ged from 5,249 (0.94%) in *Ta* to 7,743 (1.54%) in *Tr*. Since these values are within the range that we found in the reference species, we conclude that there is no unusual variation in the satellite DNA content of the *Trichoderma* genomes.

We also scanned the genomes with RepeatMasker and RepeatProteinMask [21] to identify sequences with simi-

larity to known TEs from other organisms. Thereby, sequences with significant similarity to known TEs from

orthologs that are non-syntenic. P-value: null hypothesis that the proportion of paralogous that are syntenic is less than the proportion of paralogous that are non-syntenic.

Table 3 The major classes of transposable elements found in the *Trichoderma* genomes

Class	<i>T. atroviridae</i>		<i>T. reesei</i>		<i>T. virens</i>	
	Copy number	Total length (bp)	Copy number	Total length (bp)	Copy number	Total length (bp)
DNA	372	39,899	446	50,448	370	52,358
LTR	533	64,534	559	76,482	541	67,484
Helitrons	40	9,235	45	9,962	34	8,547
LINE	561	65,202	530	54,928	349	59,414
Total ^a		178,870 (0.49%)		191,820 (0.57%)		187,803 (0.48%)

^aTotal in base pairs and percentage of genome of transposable elements found in the genomes. LINE, long interspersed nuclear element, LTR, long terminal repeat.

Based on these results, we conclude that no extant, functional TEs exist in the *Trichoderma* genomes. The presence of ancient, degenerate TE copies suggests that *Trichoderma* species are occasionally subject to infection, or invasion by TEs, but that the TEs are rapidly rendered unable to replicate and rapidly accumulate mutations.

Evidence for the operation of repeat-induced point mutation in *Trichoderma*

The paucity of transposons in *Trichoderma* could be due to repeat-induced point mutation (RIP), a gene silencing mechanism. In *N. crassa* and many other filamentous fungi, RIP preferentially acts on CA dinucleotides, changing them to TA [22]. Thus, in sequences that have been subject to RIP, one should expect to find a decrease in the proportion of CA dinucleotides and its complement dinucleotide TG as well as a corresponding

increase in the proportion of TA dinucleotides. The RIP indices TA/AT and $(CA + TG)/(AC + GT)$ developed by Margolin et al. [22] can be used to detect sequences that have been subject to RIP. Sequences that have been subjected to RIP are expected to have a high TA/AT ratio and low $(CA + TG)/(AC + GT)$ ratio, with values >0.89 and <1.03 , respectively, being indicative of RIP [22,23].

To identify evidence for RIP in the TE sequences, we computed RIP indices for four of the most prevalent TE families in each of the three species (Table 4). Since many of the sequences are very short, we computed the sum of the dinucleotide values within each TE family within each species, and used the sums to compute the RIP ratios. In only one of the 12 families did we find that both RIP indices were within the ranges that are typically used as criteria for RIP. Most of the TE sequences that we identified in the *Trichoderma* genomes are highly degenerate and have likely continued to accumulate mutations after the RIP process has acted on them. We suspect that these mutations have masked the underlying bias in dinucleotide frequencies, making the RIP indices ineffective at identifying the presence of RIP. To overcome this, we also prepared manually curated multiple sequence alignments of the TE families, selecting only sequences that had the highest sequence similarity, and thus should represent the most recent transposon insertion events in the genomes. We were able to prepare curated alignments for all four of the test TE families of *Tr* and *Tv* only for the long terminal repeat element Gypsy and the long interspersed nuclear element R1 in *Ta* (Table S2 in Additional file 1). Among DNA sequences that make up these ten alignments, we detected RIP indices within the parameters that are indicative of RIP in seven alignments. In addition, all seven alignments have high transition/transversion ratios, as is expected in sequences that are subject to RIP.

Finally, screening of the genome sequences of *Tr*, *Ta* and *Tv* identified orthologues of all genes required for RIP in *N. crassa* (Table 5).

Table 4 Repeat-induced point mutation ratios for four of the most abundant transposable element families in the three *Trichoderma* species

Sequence	TA/AT ratio	CT+AT/AC+GT ratio	RIP ^a
<i>T. atroviridae</i>	0.70	1.35	
LTR Copia	0.42	1.50	
LTR Gypsy	0.97	1.21	
LINER1	1.86	1.67	
LINE Tad1	0.82	1.32	
<i>T. reesei</i>	0.71	1.28	
LTR Copia	1.04	1.31	
LTR Gypsy	1.01	1.28	
LINER1	0.99	2.40	
LINE Tad1	0.33	1.30	
<i>T. virens</i>	0.71	1.33	
LTR Copia	0.77	1.48	
LTR Gypsy	0.95	1.16	
LINER1	0.75	2.14	
LINE Tad1	1.33	0.99	*

^aThe asterisk indicates the family Tad1 from *T. virens* in which the RIP ratios fall within values that are typically associated with RIP. LINE, long interspersed nuclear element; LTR, long terminal repeat; RIP, repeat-induced point mutation; TE, transposable element.

Table 5 Presence of genes in *Trichoderma* known to be required in *N. crassa* for repeat-induced point mutation

N. crassa protein ^a	Accession number ^a	Function ^a	Trichoderma orthologue (ID number)		
			T. atroviride	T. virens	T. reesei
RIP					
RID	XP_959047.1	Putative DMT, essential for RIP and for MIP			
Dim-5	XP_957479.2	Histone 3-K9 HMT essential for RIP; RdRP	152017	55211	515216
Quelling					
QDE-1	XP_959047.1	RdRP, essential for quelling	361	64774	67742
QDE-2	XP_960365.2	Argonaute-like protein, essential for quelling	79413	20883	49832
QDE-3	XP_964030.2	RecQ helicase, essential for quelling	91316	30057	102458
DCL1	XP_961898.1	Dicer-like protein, involved in quelling	20162	20212	69494
DCL2	XP_963538.2	Dicer-like protein, involved in quelling	318	47151	79823
QIP	CAP68960.1	Putative exonuclease protein, involved in quelling	14588	41043	57424
MSUD					
SAD-1	XP_964248.2	RdRP essential for MSUD	465	28428	103470
SAD-2	XP_961084.1	Essential for MSUD	No	No	No

^aN. crassa gene information and abbreviations taken from [36]. DMT, cytosine DNA methyltransferase; HMT, histone methyltransferase; MIP, methylation induced premeotically; MSUD, meiotic silencing of unpaired DNA; RdRP, RNA-dependent RNA-polymerase.

Paralogous gene expansion in *T. atroviride* and *T. virens* We used Marcov cluster algorithm (MCL) analysis [24] and included ten additional ascomycete genomes present in the Joint Genome Institute (JGI) genome database (including Eurotiomycetes, Sordariomycetes and Dothidiomycetes) to identify paralogous gene families that have become expanded either in all three *Trichoderma* species or only in the two mycoparasitic *Trichoderma* species. Forty-six such families were identified for all three species, of which 26 were expanded only in *Ta* and *Tv*. The largest paralogous expansions in all three *Trichoderma* species have occurred with genes encoding Zn(2)Cys(6) transcription factors, solute transporters of the major facilitator superfamily, short chain alcohol dehydrogenases, S8 peptidases and proteins bearing ankyrin domains (Table 6). The most expanded protein sets, however, were those that were considerably smaller in *Tr* ($P < 0.05$). These included ankyrin proteins with CCHC zinc finger domains, proteins with WD40, heteroincompatibility (HET) and NACHT domains, NAD-dependent epimerases, and sugar transporters.

Genes with possible relevance for mycoparasitism are expanded in *Trichoderma*

Mycoparasitism depends on a combination of events that include lysis of the prey's cell walls [3,4,7]. The necessity to degrade the carbohydrate armor of the prey's hyphae is reflected in an abundance of chitinolytic enzymes (composing most of the CAZy (Carbohydrate-Active enZYmes database) glycoside hydrolase (GH) family GH18 fungal proteins along with more rare endo-b-N-acetylglucosaminidases) and b-1,3-glucanases (families GH17, GH55, GH64, and GH81) in

Trichoderma relative to other fungi. Family GH18, containing enzymes involved in chitin degradation, is also strongly expanded in *Trichoderma*, but particularly in *Tv* and *Ta*, which contain the highest number of chitinolytic enzymes of all described fungi (Table 7). Chitin is a substantial component of fungal cell walls and chitinases are therefore an integral part of the mycoparasitic attack [3,25]. It is conspicuous that not only was the number of chitinolytic enzymes elevated but that many of these chitinases contain carbohydrate binding domains (CBMs). Mycoparasitic *Trichoderma* species are particularly rich in subgroup B chitinases that contain CBM1 modules, historically described as cellulose binding modules, but binding to chitin has also been demonstrated [26]. *Tv* and *Ta* each have a total of five CBM1-containing GH18 enzymes. Subgroup C chitinases possess CBM18 (chitin-binding) and CBM50 modules (also known as LysM modules; described as peptidoglycan- and chitin-binding modules). Interestingly, CBM50 modules in *Trichoderma* are found not only in chitinases but also frequently as multiple copies in proteins containing a signal peptide, but with no identifiable hydrolase domain. In most cases these genes can be found adjacent to chitinases in the genome.

Together with the expanded presence of chitinases, the number of GH75 chitosanases is also significantly expanded in all three analyzed *Trichoderma* species. As with plant pathogenic fungi [27,28], we have also observed an expansion of plant cell wall degrading enzyme gene families. A full account of all the carbohydrate active enzymes is presented in Tables S3 to S8 in Additional file 1. Additional details about the *Trichoderma* CAZome (the genome-wide inventory of CAZy) are given in Chapter 1 of Additional file 2.

Table 6 Major paralogous gene expansions in *Trichoderma*

PFAM domain	T. reesei	T. virens	T. atroviride	Other fungi ^a
Unknown protein with ankyrin (PF00023), CCHC zinc finger (PF00098, C-X2-C-X4-H-X4-C) and purine nucleoside phosphorylase domain (01048)	19	38	45	4
Zn(II)Cys6 transcription factor (00172) cluster 1-5	20	43	42	5,1
Peptidase S8 subtilisin cluster 1-4	10	33	36	9,6
Unknown protein with WD40, NACHT and HET domain	13	38	35	3,4
Short chain alcohol dehydrogenase (PF00106) cluster 1 and 2	20	32	34	4,7
Unknown protein family 1-4	12	25	28	5
NAD-dependent epimerase (PFAM 01370)	10	21	23	5,8
Isoflavon reductase, plus PAPA-1 (INO80 complex subunit B), epimerase and Nmr1 domain	9	18	19	6
Ankyrin domain protein	10	17	19	8
Sugar transporters	11	24	18	10,8
GH18 chitinases	6	11	16	2
Protein kinase (00069) plus TPR domain	2	24	15	4,7
Unknown major facilitator subfamily (PF07690) domain	9	15	15	5,5
F-box domain protein	7	10	11	1,7
Ankyrin domain protein with protein kinase domain	6	8	11	2,7
Amidase	4	11	11	2,8
Epoxide hydrolase (PF06441) plus AB hydrolase_1 (PF00561)	5	14	11	3,2
FAD_binding_4, plus HET and berberine bridge enzymes (08031) domain	5	13	11	6,1
FMN oxidoreductases	2	8	10	2,5
Unknown protein with DUF84 (NTPase) and NmrA domain	5	19	10	3,7
Protein with GST_N and GST_C domains	6	12	10	4,6
Class II hydrophobins	6	8	9	1,1
Proteins with LysM binding domains	6	7	9	1,2
Unknown protein family with NmrA domain	2	11	8	0,2
Pro_CA	5	9	8	1,3
WD40 domain protein	5	11	8	2,2
C2H2 transcription factors	1	5	7	1,4
GFO_IDH_MocA (01408 and 02894) oxidoreductase	3	9	7	1,5
Protein kinase (00069)	4	6	6	0,7
Nonribosomal peptide synthase	3	4	5	1
SSCP ceratoplatenin-family	3	4	5	1
GH75 chitosanase	3	5	5	1,1
SNF2, DEAD box helicase	3	5	5	1,3
Nitrilase	3	6	5	2,2
GH65 trehalose or maltose phosphorylase (PFAM 03632)	4	4	4	0,8
AAA-family ATPase (PF00004)	4	3	4	1
Pyridoxal phosphate dependent decarboxylase (00282)	2	3	4	1,2
Unknown protein	3	4	4	1,3

^aResults are from MCL analysis of the three *Trichoderma* species (Tr, Ta, Tv) and mean values from ten other ascomycetes whose genomes are present in the JGI database [63]. Eurotiomycetes: *Aspergillus carbonarius*, *Aspergillus niger*. Sordariomycetes: *Thielavia terrestris*, *Chaetomium globosum*, *Cryphonectria parasitica*, *Neurospora discreta*, *Neurospora tetrasperma*. Dothidiomycetes: *Mycosphaerella graminicola*, *Mycosphaerella fijiensis*, *Cochliobolus heterostrophus*. The number of genes present in the "other fungi" is averaged. Data were selected from a total of 28,919 clusters, average cluster number 5.8 (standard deviation 15.73). PFAM categories printed in bold specify those that are significantly ($P < 0.05$) expanded in all three *Trichoderma* species; numbers in bold and italics specify genes that are significantly more abundant in Ta and Tv versus Tr ($P < 0.05$). GH, glycosyl hydrolase family; GST, glutathione-S transferase; SSCP, small secreted cystein-rich protein.

Another class of genes of possible relevance to myco-parasitism are those involved in the formation of secondary metabolites (Chapter 2 of Additional file 2). With respect to these, the three *Trichoderma* species contained a varying assortment of non-ribosomal

peptide synthetases (NRPS) and polyketide synthases (PKS) (Table 8; see also Tables S9 and S10 in Additional file 1). While Tr (10 NRPS, 11 PKS and 2 NRPS/PKS fusion genes [8]) ranked at the lower end when compared to other ascomycetes, Tv exhibited the highest

Table 7 Glycosyl hydrolase families involved in chitin/chitosan and b-1,3 glucan hydrolysis that are expanded in mycoparasitic *Trichoderma* species

	Taxonomy	Glycosyl hydrolase family						Total β -glucan ^b
		Chitin/chitosan ^a			β -glucan ^a			
		GH18	GH75	GH17	GH55	GH64	GH81	
<i>Trichoderma atroviride</i>	S	29	5	5	8	3	2	18
<i>Trichoderma virens</i>	S	36	5	4	10	3	1	18
<i>Trichoderma reesei</i>	S	20	3	4	6	3	2	15
Pezizomycota								
<i>Nectria haematococca</i>	S	28	2	6	5	2	1	14
<i>Fusarium graminearum</i>	S	19	1	6	3	2	1	12
<i>Neurospora crassa</i>	S	12	1	4	6	2	1	13
<i>Podospora anserina</i>	S	20	1	4	7	1	1	13
<i>Magnaporthe grisea</i>	S	14	1	7	3	1	2	13
<i>Aspergillus nidulans</i>	E	19	2	5	6	0	1	12
<i>Aspergillus niger</i>	E	14	2	5	3	0	1	9
<i>Penicillium chrysogenum</i>	E	9	1	5	3	2	1	11
<i>Tuber melanosporum</i>	P	5	1	4	2	0	3	9
Other ascomycetes								
<i>Saccharomyces cerevisiae</i>	SM	2	0	4	0	0	2	6
<i>Schizosaccharomyces pombe</i>	SS	1	0	1	0	0	1	2
Basidiomycota								
<i>Phanerochaete chrysosporium</i>	A	11	0	2	2	0	0	4
<i>Laccaria bicolor</i>	A	10	0	4	2	0	0	6
<i>Postia placenta</i>	A	20	0	4	6	0	0	10

^aMain substrates for the respective enzyme families. ^bNumber of all enzymes that can act on β -glucan as a substrate. Taxonomy abbreviations: S, Sordariomycetes; E, Eurotiomycetes; P, Pezizomycetes; SM, Saccharomycetes; SS, Schizosaccharomycetes; A, Agaricomycetes. The bold numbers indicate glycosyl hydrolase (GH) families that have a statistically significant expansion in *Trichoderma* ($P < 0.05$) or Ta and Tv (GH18). This support was obtained only when *N. haematococca* and *T. melanosporum* were not included in the analysis of GH18 and GH81, respectively.

number (50) of PKS, NRPS and PKS-NRPS fusion genes, mainly due to the abundance of NRPS genes (28, twice as much as in other fungi). A phylogenetic analysis showed that this was due to recent duplications of genes encoding cyclodipeptide synthases, cyclosporin/enniatin

Table 8 The number of polyketide synthases and non-ribosomal peptide synthetases of *Trichoderma* compared to other fungi

Fungal species	PKS	NRPS	PKS-NRPS NRPS-PKS	Total
<i>Trichoderma virens</i>	18	28	4	50
<i>Aspergillus oryzae</i>	26	14	4	44
<i>Aspergillus nidulans</i>	26	13	1	40
<i>Cochliobolus heterostrophus</i>	23	11	2	36
<i>Trichoderma atroviride</i>	18	16	1	35
<i>Magnaporthe oryzae</i>	20	6	8	34
<i>Fusarium graminearum</i>	14	19	1	34
<i>Gibberella moniliformis</i>	12	16	3	31
<i>Botryotinia fuckeliana</i>	17	10	2	29
<i>Aspergillus fumigatus</i>	13	13	1	27
<i>Nectria haematococca</i>	12	12	1	25
<i>Trichoderma reesei</i>	11	10	2	23
<i>Neurospora crassa</i>	7	3	0	10

synthase-like proteins, and NRPS-hybrid proteins (Figure S1 in Additional file 3). Most of the secondary metabolite gene clusters present in Tr were also found in Tv and Ta, but about half of the genes remaining in the latter two are unique for the respective species, and are localized on non-syntenic islands of the genome (see below). Within the NRPS, all three *Trichoderma* species contained two peptaibol synthases, one for short (10 to 14 amino acids) and one for long (18 to 25 amino acids) peptaibols. The genes encoding long peptaibol synthase lack introns and produce an mRNA that is 60 to 80 kb long that encodes proteins of approximately 25,000 amino acids, the largest fungal proteins known.

Besides PKS and NRPS, Ta and Tv have further augmented their antibiotic arsenal with genes for cytolytic peptides such as aegerolysins, pore-forming cytolytic peptides typically present in bacteria, fungi and plants, yeast-like killer toxins and cyanovirins (Chapter 2 of Additional file 2). In addition, we found two high molecular weight toxins in Ta and Tv that bear high similarity (E-value 0 for 97% coverage) to the Tc ('toxin complex') toxins of *Photobacterium luminescens*, a bacterium that is mutualistic with entomophagous nematodes [29] (Table S11 in Additional file 1). Apart from *Trichoderma*, they are

also present in *G. zeae* and *Podospora anserina*. Yet there may be several more secondary metabolite genes

to be detected: *Trichoderma* species contain expanded arrays of cytochrome P450 CYP4/CYP19/CYP26 subfamilies (Table S12 in Additional file 1), and of soluble epoxide hydrolases that could act on the epoxides produced by the latter (Figure S2 in Additional file 3).

The *Hypocrea/Trichoderma* genomes also contain an abundant arsenal of putatively secreted proteins of 300 amino acids or less that contain at least four cysteine residues (small secreted cysteine-rich proteins (SSCPs); Chapter 3 of Additional file 2). They contained both unique and shared sets of SSCPs, with a higher complexity in Tv and Ta than in Tr (Table S13 in Additional file 1).

Genes present in *T. atroviride* and *T. virens* but not in *T. reesei*

As mentioned above, 1,273 orthologous genes were

shared between Ta and Tv but absent from Tr. When the encoded proteins were classified according to their PFAM domains, fungal specific Zn(2)Cys(6) transcription factors (PF00172, PF04082) and solute transporters (PF07690, PF00083), all of unknown function, were most abundant (Table S14 in Additional file 1). However, the presence of several PFAM groups of oxidoreductases and monooxygenases, and of enzymes for AMP activation of acids, phosphopatheine attachment and synthesis of isoquinoline alkaloids was also intriguing. This suggests that Ta and Tv may contain an as yet undiscovered reservoir of secondary metabolites that may contribute to their success as mycoparasites.

We also annotated the 577 genes that are unique in *T. reesei*: the vast majority of them (465; 80.6%) encoded proteins of unknown function or proteins with no homologues in other fungi. The remaining identified 112 genes exhibited no significant abundance in particular groups, except for four Zn(2)Cys(6) transcription factors, four ankyrins, four HET-domain proteins and three WD40-domain containing proteins.

Evolution of the non-syntenic regions

A search for overrepresentation of PFAM domains and Gene Ontology terms in the non-syntenic regions described above revealed that all retroposon hot spot repeat domains [30] are found in the non-syntenic regions. In most eukaryotes, these regions are located in subtelomeric areas that exhibit a high recombination frequency [31]. In addition, the genes for the protein families in Tv and Ta that were significantly more abundant compared to Tr were enriched in the non-syntenic areas (Table 9). In addition, the number of paralogous genes was significantly increased in the non-syntenic regions. We considered three possible explanations for

Table 9 Number of PFAM domains that are enriched among paralogous genes in non-syntenic areas

	<i>T. reesei</i>	<i>T. virens</i>	<i>T. atroviride</i>
Zn2Cys6 transcription factors	9	95	69
WD40 domains	1	11	14
Sugar transporters	0	18	13
Proteases	2	28	23
Cytochrome P450	7	40	15
NmrA-domains	2	19	21
Major facilitator superfamily	7	52	60
HET domains	3	26	27
Glycoside hydrolases	3	33	26
FAD-binding proteins	2	28	24
Ankyrins	4	44	37
Alcohol dehydrogenases	4	51	71
α/β -fold hydrolases	2	26	15
ABC transporters	4	14	3
Number of genes	50	485	418
Total gene number in NS areas	92	686	1012

Boxed numbers are those that are significantly ($p < 0.05$) different from the two other species when related to the genome size. PFAM, protein family; NS, non-syntenic; HET, heteroincompatibility.

this: the non-syntenic genes were present in the last common ancestor of all three *Trichoderma* species but were then selectively and independently lost; the non-syntenic areas arose from the core genome by duplication and divergence during evolution of the genus *Trichoderma*; and the non-syntenic genes were acquired by horizontal transfer. To distinguish among these hypotheses for their origin, we compared the sequence characteristics of the genes in the non-syntenic regions to those present in the syntenic regions in *Trichoderma* and genes in other filamentous fungi. We found that the majority (>78%) of the syntenic as well as non-syntenic encoded proteins have their best BLAST hit to other ascomycete fungi, indicating that the non-syntenic regions are also of fungal origin. Also, a high number of proteins encoded in the non-syntenic regions of Ta and Tv have paralogs in the syntenic region. Finally, codon usage tables and codon adaptation index analysis [32] indicate that the non-syntenic genes exhibit a similar codon usage (Figure S3 in Additional file 3). Taken together, the most parsimonious explanation for the presence of the paralogous genes in Ta and Tv is that the non-syntenic genes arose by gene duplication within a *Trichoderma* ancestor, followed by gene loss in the three lineages, which was much stronger in Tr.

Tr, Ta and Tv each occupy very diverse phylogenetic positions in the genus *Trichoderma*, as shown by a Bayesian rpb2 tree of 110 *Trichoderma* taxa (Figure 2). In order to determine which of the three species more likely resembles the ancestral state of *Trichoderma*, we performed a Bayesian phylogenetic analysis [33] using a

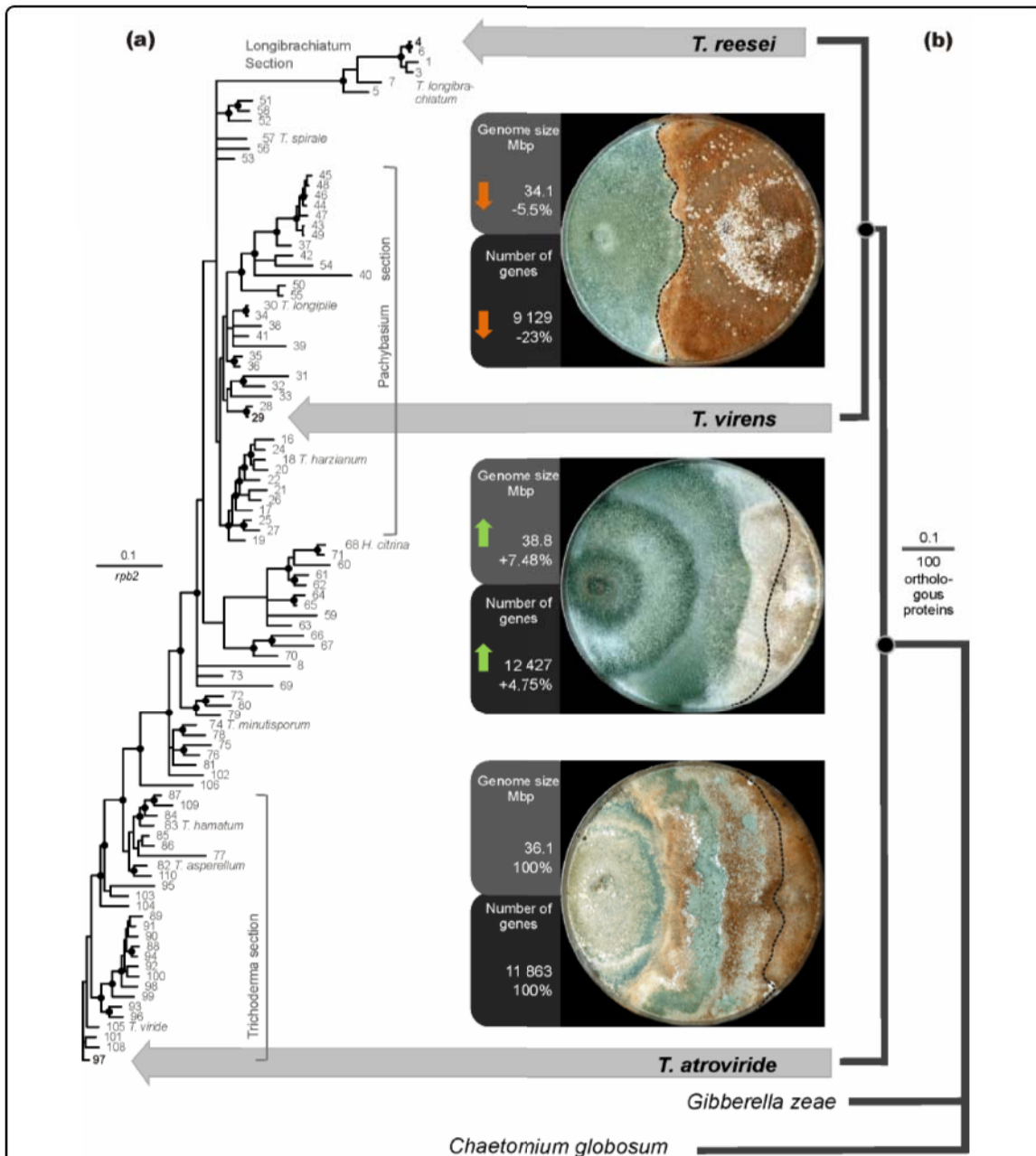

Figure 2 Mycoparasitism is an ancient life style of Trichoderma (a) Position of Ta, Tv and Tr within the genus Hypocrea/Trichoderma. The positions of Tr, Tv and Ta are 4, 29 and 97, respectively - shown in bold), and a few hallmark species are given by their names. For the identities of the other species, see the gene accession numbers (Materials and methods). (b) Bayesian phylogram based on the analysis of amino acid sequences of 100 orthologous syntenic proteins (MCMC, 1 million generations, 10,449 characters) in Tr, Tv, Ta, Gibberella zeae and Chaetomium globosum. Circles above nodes indicate 100% posterior probabilities and significant bootstrap coefficients. The numbers in the boxes between (a) and (b) indicate the genome sizes and gene counts and percentage net gain regarding Ta. Photoplates show the mycoparasitic reaction after the contact between Trichoderma species and Rhizoctonia solani. Trichoderma species are always on the left side; dashed lines indicate the position of Trichoderma overgrowth of R. solani.

concatenated set of 100 proteins that were encoded by orthologous genes in syntenic areas in the three *Trichoderma* species and also *G. zeae* and *Chaetomium globosum*. The result (Figure 2) shows that Ta occurs in a well-supported basal position to Tv and Tr. These data indicate that Ta resembles the more ancient state of *Trichoderma* and that both Tv and Tr evolved later. The lineage to Tr thus appears to have lost a significant number of genes present in Ta and maintained in Tv. The long genetic distance of Tr further suggests that it was apparently evolving faster than Ta and Tv since the time of divergence.

To test this assumption, we compared the evolutionary rates of the 100 orthologous and syntenic gene families between the three *Trichoderma* species. The median values of the evolutionary rates (K_s and K_a) of Ta-Tr and Tv-Tr were all significantly higher (1.77 and 1.47, and 1.33 and 1.19, respectively) than those of Ta-Tv (1.13 and 0.96; all P values <0.05 by the two-tailed Wilcoxon rank sum test). This result supports the above suggestion that Tr has been evolving faster than Ta and Tv.

Discussion

Comparison of the genomes of two mycoparasitic and one saprotrophic *Trichoderma* species revealed remarkable differences: in contrast to the genomes of other multicellular ascomycetes, such as aspergilli [15,17], those of *Trichoderma* appear to have the highest level of synteny of all genomes investigated (96% for Tr and still 78/79% for Tv and Ta, respectively, versus 68 to 75% in aspergilli), and most of the differences between Ta and Tv versus Tr or other ascomycetes occur in the non-syntenic areas. Nevertheless, at a molecular level the three species are as distant from each other as apes from Pices (fishes) or Aves (birds) [17], suggesting a mechanism maintaining this high genomic synteny. Espagne et al. [13] proposed that a discrepancy of genome evolution between *P. anserina*, *N. crassa* and the aspergilli and saccharomycotina yeasts is based on the difference between heterothallic and homothallic fungi: in heterothallics the presence of interchromosomal translocation could result in chromosome breakage during meiosis and reduced fertility, whereas homothallicism allows translocations to be present in both partners and thus have fewer consequences on fertility. Since *Trichoderma* is heterothallic [34], this explanation is also applicable to it. However, another mechanism, meiotic silencing of unpaired DNA [35] - which has also been proposed for *P. anserina* [13], and which eliminates progeny in crosses involving rearranged chromosomes in one of the partners - may not function in *Trichoderma* because one of the essential genes (SAD2 [36]) is missing.

Our data also suggest that the ancestral state of *Hypocrea/Trichoderma* was mycoparasitic. This supports an earlier speculation [37] that the ancestors of *Trichoderma* were mycoparasites on wood-degrading basidiomycetes and acquired saprotrophic characteristics to follow their prey into their substrate. Indirect evidence for this habitat shift in Tr was also presented by Slot and Hibbett [38], who demonstrated that Tr - after switching to a specialization on a nitrogen-poor habitat (decaying wood) - has acquired a nitrate reductase gene (which was apparently lost earlier somewhere in the Sordariomycetes lineage) by horizontal gene transfer from basidiomycetes.

Furthermore, the three *Trichoderma* species have the lowest number of transposons reported so far. This is unusual for filamentous fungi, as most species contain approximately 10 to 15% repetitive DNA, primarily composed of TEs. A notable exception is *Fusarium graminearum* [27], which, like the *Trichoderma* species, contains less than 1% repetitive DNA [8]. The paucity of repetitive DNA may be attributed to RIP, which has been suggested to occur in Tr [8] and for which we have here provided evidence that it also occurs in Ta and Tv. It is likely that this process also contributes to prevent the accumulation of repetitive elements.

The gene inventory detected in the three *Trichoderma* species reveals new insights into the physiology of this fungal genus: the strong expansion of genes for solute transport, oxidoreduction, and ankyrins (a family of adaptor proteins that mediate the anchoring of ion channels or transporters in the plasma membrane [39]) could render *Trichoderma* more compatible in its habitat (for example, to successfully compete with the other saprotrophs for limiting substrates). In addition, the expansion of WD40 domains acting as hubs in cellular networks [40] could aid in more versatile metabolism or response to stimuli. These features correlate well with a saprotrophic lifestyle that makes use of plant biomass that has been pre-degraded by earlier colonizers. The expansion of HET proteins (proteins involved in vegetative incompatibility specificity) on the other hand suggests that *Trichoderma* species may frequently encounter related yet genetically distinct individuals. In fact, the presence of several different *Trichoderma* species can be detected in a single soil sample [41]. Unfortunately, vegetative incompatibility has not yet been investigated in any *Trichoderma* species, and based on the current data, should be a topic of future research.

Finally, the abundance of SSCPs in *Trichoderma* may be involved in rhizosphere competence: the genome of the ectomycorrhizal basidiomycete *Laccaria bicolor* also encodes a large set of SSCPs, which accumulate in the hyphae that colonize the host root [42].

Gene expansions in Tv and Ta that do not occur in Tr may comprise genes specific for mycoparasitism.

As a prominent example, proteases have expanded in Ta and Tv, supporting the hypothesis that the degradation of proteins is a major trait of mycoparasites [43]. Likewise, the increase in chitinolytic enzymes and some β -glucanase-containing GH families is remarkable and illustrates the importance of destruction of the prey's cell wall in this process. With respect to the chitinases, the expansion of those bearing CBM50 modules was particularly remarkable: proteins containing these modules were recently classified into several different groups by de Jonge and Thomma [44]. Proteins that consist solely of CBM50 modules are type-A LysM proteins, and there is evidence for the role of these as virulence factors in plant pathogenic fungi. The high numbers of LysM proteins that are found in Trichoderma, however, indicate other/additional roles for these proteins in fungal biology that are not understood yet. Also, the expansion of the GH75 chitosanases was intriguing: chitosan is a partially deacetylated derivative of chitin and, depending on the fungal species and the growth conditions, in mature fungal cell walls chitin is partially deacetylated. It has also been reported that fungi deacetylate chitin as a defense mechanism [45,46]. Chitosan degradation may therefore be a relevant aspect of mycoparasitism and fungal cell wall degradation that has also not been regarded yet. Overall, the carbohydrate-active enzyme machinery present in Trichoderma is compatible with saprophytic behavior but, interestingly, the set of enzymes involved in the degradation of 'softer' plant cell wall components, such as pectin, is reduced. A possible plant symbiotic relationship [3] might rely on a mycoparasitic capacity along with a reduced specificity for pectin, minimizing the plant defense reaction.

Although the genes encoding proteins for the synthesis of typical fungal secondary metabolites (PKS, NRPS, PKS-NRPS) are also abundant, they are not significantly more expanded than in some other fungi. An exception is Tv and its 28 NRPS genes. However, our genome analysis revealed also a high number of oxidoreductases, cytochrome P450 oxidases, and other enzymes that could be part of as yet unknown pathways for the synthesis of further secondary metabolites. In support of this, several of these genes were found to be clustered in the genome (data not shown), and were more abundant in the two mycoparasitic species Ta and Tv. Together with the expanded set of oxidoreductases, monooxygenases, and enzymes for AMP activation of acids, phosphothetheine attachment, and synthesis of isoquinoline alkaloids in Ta and Tv, these genes may define new secondary metabolite biosynthetic routes.

Conclusions

Our comparative genome analysis of the three Trichoderma species now opens new opportunities for the

development of improved and research-driven strategies to select and improve Trichoderma species as biocontrol agents. The availability of the genome sequences published in this study, as well as of several pathogenic fungi and their potential host plants (for example, [47]) provides a challenging opportunity to develop a deeper understanding of the underlying processes by which Trichoderma interacts with plant pathogens in the presence of living plants within their ecosystem.

Materials and methods

Genome sequencing and assembly

The genomes of *T. virens* and *T. atroviride* each were assembled from shotgun reads using the JGI (USA Department of Energy) assembler Jazz (see Table S15 in Additional file 1 for summary of assembly statistics). Each genome was annotated using the JGI Annotation pipeline, which combines several gene prediction, annotation and analysis tools. Genes were predicted using Fgenesh [48], Fgenesh+ [49], and Genewise programs [50]. ESTs from each species (Chapter 4 of Additional file 2) were clustered and either assembled and converted into putative full-length genes directly mapped to genomic sequence or used to extend predicted gene models into full-length genes by adding 5' and/or 3' untranslated regions to the models. From multiple gene models predicted at each locus, a single representative model was chosen based on homology and EST support and used for further analysis. Gene model characteristics and support are summarized in Tables S16 and S17 in Additional file 1.

All predicted gene models were functionally annotated by homology to annotated genes from a NCBI non-redundant set and classified according to Gene Ontology [51], eukaryotic orthologous groups (KOGs) [52], and Kyoto Encyclopedia of Genes and Genomes (KEGG) metabolic pathways [53]. See Tables S18 and S19 in Additional file 1 for a summary of the functional annotation. Automatically predicted genes and functions were further refined by user community-wide manual curation efforts using web-based tools at [54,55]. The latest version gene set containing manually curated genes is called GeneCatalog.

Assembly and annotation data for Tv and Ta are available through JGI Genome Portals homepage at [54,55]. The genome assemblies, predicted gene models, and annotations were deposited at GenBank under project accessions [GenBank: ABDF00000000 and ABDG00000000], respectively. GenBank public release of the data described in this paper should coincide with the manuscript publication date.

Genome similarity analysis and genomic synteny

Orthologous genes, as originally defined, imply a reflection of the history of species. In recent years, many

studies have examined the concordance between orthologous gene trees and species trees in bacteria. With the purpose of identifying all the orthologous gene pairs for the three *Trichoderma* species, a best bidirectional blast hit approach as described elsewhere [56,57] was performed, using the predicted translated gene models for each of the three species as pairwise comparison sets. The areas of relationship known as syntenic regions or syntenic blocks are anchored with orthologs (calculated as mutual best hits or bi-directional best hits) between the two genomes in question, and are built by controlling for the minimum number of genes, minimum density, and maximum gap (genes not from the same genome area) compared with randomized data as described in [56]. While this technique may cause artificial breaks, it highlights regions that are dynamic and picking up a large number of insertions or duplications.

Orthologous and paralogous gene models were identified by first using BLAST to find all pairwise matches between the resulting proteins from the gene models. The pairwise matches from BLAST were then clustered into groups of paralogs using MCL [58]. In parallel we applied orthoMCL [59] to the same pairwise matches to identify the proteins that were orthologous in all of the three genomes. By subtracting all the proteins that were identified as orthologs from the groups of paralogs and unique genes, we were left with only the protein products of gene models that have expanded since the most recent common ancestor (MRCA) of the three *Trichoderma* genomes. We then calculated the P-value under the null hypothesis that the number of non-orthologous genes that are non-syntenic is less than the number of non-orthologous genes that are syntenic.

Identification of transposable elements

We scanned the *Trichoderma* genomes with the de novo repeat finding program Piler [19]. Next, we searched for sequences with similarity to known repetitive elements from other eukaryotes with the program RepeatMasker [21] using all eukaryotic repetitive elements in the RepBase (version 13.09) database. After masking repetitive sequences that matched the DNA sequence of known repetitive elements, we scanned the masked genome sequences with RepeatProteinMask (a component of the RepeatMasker application). This search located additional degenerate repetitive sequences with similarity to proteins encoded by TEs in the RepBase database.

CAZome identification and analysis

All protein models for Ta and Tv were compared against the set of libraries of modules derived from CAZy [60,61]. The identified proteins were subjected to manual analysis for correction of the protein models, for full modular annotation and for functional inference

against a library of experimentally characterized enzymes. Comparative analysis was made by the enumeration of all modules identified in the three *Trichoderma* species and 14 other published fungal genomes.

Phylogenetic and evolutionary analyses

One-hundred genes were randomly selected from Ta, Tv, Tr and *C. globosum* based on their property to fulfill two requirements: they were in synteny in all four genomes, and they were true orthologues (no other gene encoding a protein with amino acid similarity >50% present). After alignment, the concatenated 10,449 amino acids were subjected to Bayesian analysis [33] using 1 million generations. The respective cDNA sequences (31,347 nucleotides) were also concatenated, and Ks/Ka ratios determined using DNASp5 [62]. The same file was also used to determine the codon adaptation index [32]. In addition, 80 non-syntenic genes were also selected randomly for this purpose.

The species phylogram of *Trichoderma/Hypocrea* was constructed by Bayesian analysis of partial exon nucleotide sequences (824 total characters from which 332 were parsimony-informative) of the *rpb2* gene (encoding RNA polymerase B II) from 110 ex-type strains, thereby spanning the biodiversity of the whole genus. The tree was obtained after 5 million MCMC generations sampled for every 100 trees, using burnin = 1200 and applying the general time reversible model of nucleotide substitution. The NCBI ENTREZ accession numbers are: 1 [HQ260620]; 3 [DQ08724]; 4 [HM182969]; 5 [HM182984]; 6 [HM182965]; 7 [AF545565]; 8 [AF545517]; 16 [FJ442769]; 17 [AY391900]; 18 [FJ179608]; 19 [FJ442715]; 20 [FJ442771]; 21 [AY391945]; 22 [EU498358]; 23 [DQ834463]; 24 [FJ442725]; 25 [AF545508]; 26 [AY391919]; 27 [AF545557]; 28 [AF545542]; 29 [FJ442738]; 30 [AF545550]; 31 [AY391909]; 32 [AF545516]; 33 [AF545518]; 34 [AF545512]; 35 [AF545510]; 36 [AF545514]; 37 [AY391921]; 38 [AF545513]; 39 [AY391954]; 40 [AY391944]; 41 [AF545534]; 42 [AY391899]; 43 [AY391907]; 44 [AF545511]; 45 [AY391929]; 46 [AF545540]; 47 [AY391958]; 48 [AY391924]; 49 [AF545515]; 50 [AY391957]; 51 [AF545551]; 52 [AF545522]; 53 [FJ442714]; 54 [AF545509]; 55 [AY391959]; 56 [DQ087239]; 57 [AF545553]; 58 [AF545545]; 59 [DQ835518]; 60 [DQ835521]; 61 [DQ835462]; 62 [DQ835465]; 63 [DQ835522]; 64 [AF545560]; 65 [DQ835517]; 66 [DQ345348]; 67 [AF545520]; 68 [DQ835455]; 69 [AF545562]; 70 [AF545563]; 71 [DQ835453]; 72 [FJ179617]; 73 [DQ859031]; 74 [EU341809]; 75 [FJ179614]; 76 [DQ087238]; 77 [AF545564]; 78 [FJ179601]; 79 [FJ179606]; 80 [FJ179612]; 81 [FJ179616]; 82 [EU264004]; 83 [FJ150783]; 84 [FJ150767]; 85

[FJ150786]; 86 [EU883559]; 87 [FJ150785]; 88 [EU248602]; 89 [EU241505]; 90 [FJ442762]; 91 [FJ442741]; 92 [FJ442783]; 93 [EU341805]; 94 [FJ442723]; 95 [FJ442772]; 96 [EU2415023]; 97 [EU341801]; 98 [EU248600]; 99 [EU341808]; 100 [EU3418033]; 101 [EU2485942]; 102 [AF545519]; 103 [EU248603]; 104 [EU248607]; 105 [EU341806]; 106 [DQ086150]; 107 [DQ834460]; 108 [EU711362]; 109 [EU883557]; 110 [FJ150790].

Additional material

Additional file 1: Comparative properties and gene inventory of *T. reesei*, *T. virens* and *T. atroviride*. This file contains additional information on genomic properties and selected gene families from the three *Trichoderma* species comprising 19 tables. Table S1 summarizes the satellite sequences identified in the *Trichoderma* genomes and four other fungal genomes. Table S2 summarizes manually curated sequence alignments of transposable element families from the *Trichoderma* genomes. Table S3 lists the total number of CAZy families in *Trichoderma* and other fungi. Table S4 lists the glycoside hydrolase (GH) families in *Trichoderma* and other fungi. Table S5 lists the glycosyltransferase (GT) families in *Trichoderma* and other fungi. Table S6 lists the polysaccharide lyase (PL) families in *Trichoderma* and other fungi. Table S7 lists the carbohydrate esterase (CE) families in *Trichoderma* and other fungi. Table S8 lists the carbohydrate-binding module (CBM) families in *Trichoderma* and other fungi. Table S9 lists the NRPS, PKS and NRPS-PKS proteins in *T. atroviride*. Table S10 lists NRPS, PKS and NRPS-PKS proteins in *T. virens*. Table S11 lists the putative insecticidal toxins in *Trichoderma*. Table S12 lists the cytochrome P450 CYP4/CYP19/CYP26 class E proteins in *Trichoderma*. Table S13 lists the small-cysteine rich secreted protein from *Trichoderma* spp. Table S14 lists the most abundant PFAM domains in those genes that are unique to *T. atroviride* and *T. virens* and not present in *T. reesei*. Table S15 surveys the assembly statistics. Table S16 provides gene model support. Table S17 summarizes gene model statistics. Table S18 provides numbers of genes with functional annotation according to KOG, Gene Ontology, and KEGG classifications. Table S19 lists the largest KOG families responsible for metabolism.

Additional file 2: Additional information on selected gene groups of *Trichoderma*, methods used for genome sequencing, and legends for the figures in Additional file 3. Chapter 1: Carbohydrate-Active enzymes (CAZymes). Chapter 2: Aegerolysins and other toxins. Chapter 3: Small secreted cysteine rich proteins (SSCPs). Chapter 4: EST sequencing and analysis. Chapter 5: Legends to figures.

Additional file 3: Figures that illustrate selected aspects of the main text. Figure S1 provides a phylogeny of *Trichoderma* NRPSs. Figure S2 compares the numbers of epoxide hydrolase genes in *Trichoderma* with that in other fungi. Figure S3 compares the codon usage in genes from syntenic and nonsyntenic regions of the genomes of *Trichoderma reesei*, *T. atroviride* and *T. virens*.

Abbreviations

CAZy: Carbohydrate-Active enZymes; CBM: carbohydrate binding module; EST: expressed sequence tag; GH: glycosyl hydrolase; HET: heteroincompatibility; KEGG: Kyoto Encyclopedia of Genes and Genomes; KOG: clusters of eukaryotic orthologous groups; NRPS: non-ribosomal peptide synthase; PKS: polyketide synthase; RIP: repeat-induced point mutation; SSCP: small secreted cysteine-rich protein; Ta: *Trichoderma atroviride*; TE: transposable element; Tr: *Trichoderma reesei*; Tv: *Trichoderma virens*.

Acknowledgements

Genome sequencing and analysis was conducted by the US Department of Energy Joint Genome Institute and supported by the Office of Science of

the US Department of Energy under contract number DE-AC02-05CH11231. MGC-B, EYG-R, MH-O, and EEU-R are indebted to Conacyt for doctoral fellowships. SLC and FC was supported by the Infraestructuras en Biologie Santé et Agronomie (IBISA). EM and RH work was supported by the grants Junta de Castilla y León GR67, MICINN AGL2008-0512/AGR and AGL2009-13431-C02. The work of ISD, VS-S, LA, BS, BM, SZ, MS, and CPK was supported by the Austrian Science Foundation (grants FWF P17895-B06, P20559, T390, P18109-B12, P-19421, V139B20 and P-19340). The work of PMC and BH was supported by project number AANR-07-BIOE-006 from the French national program PNRB. MF was the recipient of a postdoctoral contract Ramón y Cajal from the Spanish Ministry of Science and Innovation (MCINN: RYC-2004-003005). SZ acknowledges support from the Vienna Science and Technology Fund (WWTF LS09-036).

Author details

¹Area Gene Technology and Applied Biochemistry, Institute of Chemical Engineering Vienna University of Technology, Getreidemarkt 9, 1060 Vienna, Austria. ²Laboratorio Nacional de Genómica para la Biodiversidad, Cinvestav Campus Guanajuato, Km. 9.6 Libramiento Norte, Carretera Irapuato-León, 36821 Irapuato, Mexico. ³Broad Institute of MIT and Harvard, 301 Binney St, Cambridge, MA 02142, USA. ⁴Centro Hispanoluso de Investigaciones Agrarias (CIALE), Department of Microbiology and Genetics, University of Salamanca, Calle Del Duero, 12, Villamayor 37185, Spain. ⁵División de Biología Molecular, Instituto Potosino de Investigación Científica y Tecnológica, Camino a la Presa San José, No. 2055, Colonia Lomas 4a Sección, San Luis Potosí, SLP., 78216, México. ⁶Department of Biology, Technion - Israel Institute of Technology, Neve Shaanan Campus, Technion City, Haifa, 32000, Israel. ⁷Nuclear Agriculture and Biotechnology Division, Bhabha Atomic Research Centre, Trombay, Mumbai 400085, India. ⁸Department of Microbiology, Faculty of Science and Informatics, University of Szeged, Közép fasor 52, Szeged, H-6726, Hungary. ⁹DOE Joint Genome Institute, 2800 Mitchell Drive, Walnut Creek, CA 94598, USA. ¹⁰School of Biological Sciences, University of Missouri- Kansas City, 5007 Rockhill Road, Kansas City, MO 64110, USA. ¹¹Institut de Biologie de l'École normale supérieure (IBENS), Institut National de la Santé et de la Recherche Médicale U1024, Centre National de la Recherche Scientifique UMR8197, 46, rue d'Ulm, Paris 75005, France. ¹²Chemistry and Biomolecular Sciences, Macquarie University, Research Park Drive Building F7B, North Ryde, Sydney, NSW 2109, Australia. ¹³TU Berlin, Institut für Chemie, FG Biochemie und Molekulare Biologie OE2, Franklinstr. 29, 10587 Berlin, Germany. ¹⁴Department of Plant Pathology and Microbiology Building 0444, Nagle Street, Texas A&M University College Station, TX 77843, USA. ¹⁵Department of Biochemical Engineering, Faculty of Science and Technology, University of Debrecen, Egyetem tér 1, Debrecen, H-4010, Hungary. ¹⁶Instituto de Agroquímica y Tecnología de Alimentos, Consejo Superior de Investigaciones Científicas, Apartado de Correos 73, Burjassot (Valencia) E-46100, Spain. ¹⁷Architecture et Fonction des Macromolécules Biologiques, UMR6098, CNRS, Université de la Méditerranée, Case 932, 163 Avenue de Luminy, 13288 Marseille 13288, France. ¹⁸Department of Biotechnology, Chemistry and Environmental Engineering, Aalborg University, Lautrupvang 15, DK-2750 Ballerup, Denmark. ¹⁹Biotechnology Department, IFP Energies nouvelles, 1-4 avenue de Bois Préau, Rueil-Malmaison, 92852, France. ²⁰Institute of Sciences of Food Production (ISPA), National Research Council (CNR), Via Amendola 122/O, 70126 Bari, Italy. ²¹Wageningen University, Systems and Synthetic Biology, Fungal Systems Biology Group, Dreijenplein 10, 6703 HB Wageningen, The Netherlands. ²²Chemical and Biological Process Development Group, Pacific Northwest National Laboratory, 902 Battelle Boulevard, Richland, WA 99352, USA.

Authors' contributions

CPK, IVG, BH, EM, SEB, CMK, and AHE contributed equally to this work as senior authors. AA, JC, MM, AS, and IVG performed global annotation and analysis, MZ and HS did the assembly, OC and CH finished the assembly, and EL and SL performed the genome and EST sequencing. SEB, AH-E, CMK and CPK designed the study, and coordinated and supervised the analysis; CPK drafted and submitted the paper. All other authors contributed research (annotations and/or analyses). All authors read and approved the final manuscript.

Received: 31 December 2010 Revised: 28 March 2011

Accepted: 18 April 2011 Published: 18 April 2011

References

- Taylor TN, Hass H, Kerp H, Krings M, Hanlin RT: Perithecial ascomycetes from the 400 million year old Rhynie chert: an example of ancestral polymorphism. *Mycologia* 2005, 97:269-285.
- Vincent C, Goettel MS, Lazarovits G: *Biological Control: A Global Perspective: Case Studies from Around the World* Wallingford, UK: CAB International; 2007.
- Harman GE, Howell CR, Viterbo A, Chet I, Lorito M: Trichoderma species-opportunistic, avirulent plant symbionts. *Nat Rev Microbiol* 2004, 2:43-56.
- Howell CR: Mechanisms employed by Trichoderma species in the biological control of plant diseases: the history and evolution of current concepts. *Plant Disease* 2003, 87:4-10.
- Harman GE: Overview of mechanisms and uses of Trichoderma spp. *Phytopathology* 2006, 96:190-194.
- Shores M, Hamman GE, Mastouri F: Induced systemic resistance and plant responses to fungal biocontrol agents. *Annu Rev Phytopathol* 2010, 48:21-43.
- Lorito M, Woo SL, Harman GE, Monte E: Translational research on Trichoderma: from 'omics to the field. *Annu Rev Phytopathol* 2010, 48:395-417.
- Martinez D, Berka RM, Henrissat B, Saloheimo M, Arvas M, Baker SE, Chapman J, Chertkov O, Coutinho PM, Cullen D, Danchin EG, Grigoriev IV, Harris P, Jackson M, Kubicek CP, Han CS, Ho I, Larrondo LF, de Leon AL, Magnuson JK, Merino S, Misra M, Nelson B, Putnam N, Robertse B, Salamov AA, Schmolli M, Terry A, Thayer N, Westerholm-Parvinen A, et al: Genome sequencing and analysis of the biomass-degrading fungus Trichoderma reesei (syn. Hypocrea jecorina). *Nat Biotechnol* 2008, 26:553-560.
- Druzhinina IS, Kopchinskiy A, Kubicek CP: The first one hundred Trichoderma species characterized by molecular data. *Mycoscience* 2006, 47:55-64.
- Chaverri P, Samuels GJ, Stewart EL: Hypocrea virens sp. nov., the teleomorph of Trichoderma virens. *Mycologia* 2001, 93:1113-1124.
- Dodd SL, Lieckfeldt E, Samuels GJ: Hypocrea atrovinidis sp. nov., the teleomorph of Trichoderma atrovinide. *Mycologia* 2003, 95:27-40.
- Druzhinina IS, Kubicek CP, Komoń-Zelazowska M, Mulaw TB, Bissett J: The Trichoderma harzianum demon: complex speciation history resulting in coexistence of agamospherical biological species, recent agamospecies and numerous relict lineages. *BMC Evol Biol* 2010, 10:94.
- Espagne E, Lespinet O, Malagnac F, Da Silva C, Jaillon O, Porcel BM, Couloux A, Aury JM, Ségurens B, Poulain J, Anthouard V, Grossetete S, Khalili H, Coppin E, Déquard-Chablat M, Picard M, Contamine V, Arnais S, Bourdais A, Berteaux-Lecellier V, Gautheret D, de Vries RP, Battaglia E, Coutinho PM, Danchin EG, Henrissat B, Khoury RE, Sainsard-Chanet A, Boivin A, Pinan-Lucaric B, et al: The genome sequence of the model ascomycete fungus *Dopospora anserina*. *Genome Biol* 2008, 9:R77.
- Fischer G, Rocha EP, Brunet F, Vergassola M, Dujon B: Highly variable rates of genome rearrangements between hemiascomycetous yeast lineages. *PLoS Genet* 2006, 2:e32.
- Galagan JE, Calvo SE, Cuomo C, Ma LJ, Wortman JR, Batzoglou S, Lee SJ, Bastürkmen M, Spevak CC, Clutterbuck J, Kapitonov V, Jurka J, Scacciochio C, Farman M, Butler J, Purcell S, Harris S, Brans GH, Draht O, Busch S, D'Enfert C, Bouchier C, Goldman GH, Bell-Pedersen D, Griffiths-Jones S, Doonan JH, Yu J, Vienken K, Pain A, Freitag M, et al: Sequencing of *Aspergillus nidulans* and comparative analysis with *A. fumigatus* and *A. oryzae*. *Nature* 2005, 438:1105-1115.
- Seoighe C, Federspiel N, Jones T, Hansen N, Bivolarov V, Surzycki R, Tamse R, Komp C, Huizar L, Davis RW, Scherer S, Tait E, Shaw DJ, Harris D, Murphy L, Oliver K, Taylor K, Rajandream MA, Barrell BG, Wolfe KH: Prevalence of small inversions in yeast gene order evolution. *Proc Natl Acad Sci USA* 2000, 97:14433-14437.
- Fedorova ND, Khaldi N, Joardar VS, Maiti R, Amedeo P, Anderson MJ, Crabtree J, Silva JC, Badger JH, Albarraq A, Angiuoli S, Bussey H, Bowyer P, Cotty PJ, Dyer PS, Egan A, Galens K, Fraser-Liggitt CM, Haas BJ, Inman JM, Kent R, Lemieux S, Malavazi I, Orvis J, Roemer T, Ronning CM, Sundaram JP, Sutton G, Turner G, Venter JC, et al: Genomic islands in the pathogenic filamentous fungus *Aspergillus fumigatus*. *PLoS Genet* 2008, 4:e1000046.
- Nadeau J, Taylor B: Lengths of chromosomal segments conserved since divergence of man and mouse. *Proc Natl Acad Sci USA* 1984, 81:814-818.
- Edgar RC, Myers EW: PILER: identification and classification of genomic repeats. *Bioinformatics* 2005, 21(Suppl 1):i152-i158.
- Benson G: Tandem repeats finder: a program to analyze DNA sequences. *Nucleic Acids Res* 1999, 27:573-580.
- RepeatMasker Open-3.0. [<http://www.repeatmasker.org>].
- Margolin BS, Garrett-Engle PW, Stevens JN, Fritz DY, Garrett-Engle C, Metzner RL, Selker EU: A methylated Neurospora 5S rRNA pseudogene contains a transposable element inactivated by repeat-induced point mutation. *Genetics* 1998, 149:1787-1797.
- Selker EU, Tountas NA, Cross SH, Margolin BS, Murphy JG, Bird AP, Freitag M: The methylated component of the Neurospora crassa genome. *Nature* 2003, 422:893-897.
- Enright AJ, van Dongen S, Ouzounis CA: An efficient algorithm for large-scale detection of protein families. *Nucleic Acids Res* 2002, 30:1575-1584.
- Seidl V: Chitinases of filamentous fungi: a large group of diverse proteins with multiple physiological functions. *Fungal Biol Rev* 2008, 22:36-42.
- Limon MC, Chacón MR, Mejías R, Delgado-Jarana J, Rincón AM, Codón AC, Benítez T: Increased antifungal and chitinase specific activities of Trichoderma harzianum CECT 2413 by addition of a cellulose binding domain. *Appl Microbiol Biotechnol* 2004, 64:675-682.
- Cuomo CA, Güldener U, Xu JR, Trail F, Turgeon BG, Di Pietro A, Walton JD, Ma LJ, Baker SE, Rep M, Adam G, Antoniw J, Baldwin T, Calvo S, Chang YL, Decaprio D, Gale LR, Gnerre S, Goswami RS, Hammond-Kosack K, Hamis LJ, Hilburn K, Kennell JC, Kroken S, Magnuson JK, Mannhaupt G, Mauceli E, Mewes HW, Mitterbauer R, Muehlbauer G, et al: The Fusarium graminearum genome reveals a link between localized polymorphism and pathogen specialization. *Science* 2007, 317:1400-1402.
- Dean RA, Talbot NJ, Ebbole DJ, Farman ML, Mitchell TK, Orbach MJ, Thon M, Kulkarni R, Xu JR, Pan H, Read ND, Lee YH, Carbone I, Brown D, Oh YY, Donofrio N, Jeong JS, Soanes DM, Djonovic S, Kolomietis E, Rehmeier C, Li W, Harding M, Kim S, Lebrun MH, Bohnert H, Coughlan S, Butler J, Calvo S, Ma LJ, et al: The genome sequence of the rice blast fungus Magnaporthe oryzae. *Nature* 2005, 434:980-986.
- Münch A, Singl L, Jung K, Heermann R: Photorhabdus luminescens genes induced upon insect infection. *BMC Genomics* 2008, 9:229.
- Wellinger RJ, Sen H: The DNA structures at the ends of eukaryotic chromosomes. *Eur J Cancer* 1997, 33:735-749.
- Freitas-Junior LH, Bottius E, Pirrit LA, Deitsch KW, Scheidig C, Guinet F, Nehrass U, Wellemis TE, Scherf A: Frequent ectopic recombination of virulence factor genes in telomeric chromosome clusters of P. falciparum. *Nature* 2000, 407:1018-1022.
- Sharp PM, Li WH: The codon adaptation index - a measure of directional synonymous codon usage bias, and its potential applications. *Nucleic Acids Res* 1987, 15:1281-1295.
- Yang Z, Rannala B: Bayesian phylogenetic inference using DNA sequences: a Markov Chain Monte Carlo Method. *Mol Biol Evol* 1997, 14:717-724.
- Seidl V, Seibel C, Kubicek CP, Schmolli M: Sexual development in the industrial workhorse Trichoderma reesei. *Proc Natl Acad Sci USA* 2009, 106:13909-13914.
- Shiu PK, Metzner RL: Meiotic silencing by unpaired DNA: properties, regulation and suppression. *Genetics* 2002, 161:1483-1495.
- Borkovich KA, Alex LA, Yarden O, Freitag M, Turner GE, Read ND, Seiler S, Bell-Pedersen D, Paietta J, Plesofsky N, Plamann M, Goodrich-Tannikulu M, Schulte U, Mannhaupt G, Nargang FE, Radford A, Selitrennikoff C, Galagan JE, Dunlap JC, Loros JJ, Catcheside D, Inoue H, Aramayo R, Polymenis M, Selker EU, Sachs MS, Marzluf GA, Paulsen I, Davis R, Ebbole DJ, et al: Lessons from the genome sequence of Neurospora crassa: tracing the path from genomic blueprint to multicellular organism. *Microbiol Mol Biol Rev* 2004, 68:1-108.
- Rossmann AY, Samuels GJ, Rogerson CT, Lowen R: Genera of Bionectriaceae, Hypocreaeae and Nectriaceae (Hypocreales, Ascomycetes). *Stud Mycol* 1999, 42:1-83.
- Slot JC, Hibbett DS: Horizontal transfer of a nitrate assimilation gene cluster and ecological transitions in fungi: a phylogenetic study. *PLoS One* 2007, 2:e1097.
- Bennett V, Bames AJ: Spectrin and ankyrin-based pathways: metazoan inventions for integrating cells into tissues. *Physiol Rev* 2001, 81:1353-1392.
- Stimimann CU, Petsalaki E, Russell RB, Müller CW: WD40 proteins propel cellular networks. *Trends Biochem Sci* 2010, 35:565-574.
- Migheli Q, Balmas V, Komoń-Zelazowska M, Scherm B, Fiori S, Kopchinskiy AG, Kubicek CP, Druzhinina IS: Soils of a Mediterranean hot spot of biodiversity and endemism (Sardinia, Tyrrhenian Islands) are inhabited by pan-European, invasive species of Hypocrea/Trichoderma. *Environ Microbiol* 2009, 11:35-46.

42. Martin F, Aerts A, Ahrén D, Brun A, Danchin EG, Duchaussoy F, Gibon J, Kohler A, Lindquist E, Pereda V: The genome of *Laccaria bicolor* provides insights into mycorrhizal symbiosis. *Nature* 2008, 452:88-92.
43. Seidl V, Song L, Lindquist E, Gruber S, Koptchinskiy A, Zeilinger S, Schmoll M, Martínez P, Sun J, Grigoriev I, Herrera-Estrella A, Baker SE, Kubicek CP: Transcriptomic response of the mycoparasitic fungus *Trichoderma atroviride* to the presence of a fungal prey. *BMC Genomics* 2009, 10:567.
44. de Jonge R, Thomma BP: Fungal LysM effectors: extinguishers of host immunity? *Trends Microbiol* 2009, 17:151-154.
45. Baker LG, Specht CA, Donlin MJ, Lodge JK: Chitosan, the deacetylated form of chitin, is necessary for cell wall integrity in *Cryptococcus neoformans*. *Eukaryotic Cell* 2007, 6:855-862.
46. El Guédari NE, Rauchhaus U, Moerschbacher BM, Deising HB: Developmentally regulated conversion of surface-exposed chitin to chitosan in cell walls of plant pathogenic fungi. *New Phytol* 2002, 156:103-111.
47. diArk: a resource for eukaryotic genome research.. [<http://www.diark.org/diark/search/>].
48. Salamov AA, Solovyyev VV: Ab initio gene finding in *Drosophila* genomic DNA. *Genome Res* 2000, 10:516-522.
49. Birney E, Durbin R: Using GeneWise in the *Drosophila* annotation experiment. *Genome Res* 2000, 10:547-548.
50. Zdobnov EM, Apweiler R: InterProScan - an integration platform for the signature-recognition methods in InterPro. *Bioinformatics* 2001, 17:847-848.
51. Ashburner M, Ball CA, Blake JA, Botstein D, Butler H, Cherry JM, Davis AP, Dolinski K, Dwight SS, Eppig JT, Harris MA, Hill DP, Issel-Tarver L, Kasarskis A, Lewis S, Matese JC, Richardson JE, Ringwald M, Rubin GM, Sherlock G: Gene Ontology: tool for the unification of biology The Gene Ontology Consortium. *Nat Genet* 2000, 25:25-29.
52. Koonin EV, Fedorova ND, Jackson JD, Jacobs AR, Krylov DM, Makarova KS, Mazumder R, Mekhedov SL, Nikolskaya AN, Rao BS, Rogozin IB, Smirnov S, Sorokin AV, Sverdlov AV, Vasudevan S, Wolf YI, Yin JJ, Natale DA: A comprehensive evolutionary classification of proteins encoded in complete eukaryotic genomes. *Genome Biol* 2004, 5:R7.
53. Kanehisa M, Goto S, Kawashima S, Okuno Y, Hattori M: The KEGG resource for deciphering the genome. *Nucleic Acids Res* 2004, 32:D277-D280.
54. *Trichoderma virens* Gv29-8 v2.0. [<http://www.jgi.doe.gov/Tvirens/>].
55. *Trichoderma atroviride* v2.0. [<http://www.jgi.doe.gov/Tatroviride/>].
56. Castillo-Ramirez S, Gonzalez V: Factors affecting the concordance between orthologous gene trees and species tree in bacteria. *BMC Evol Biol* 2008, 8:300.
57. Moreno-Hagelsieb C, Janga SC: Operons and the effect of genome redundancy in deciphering functional relationships using phylogenetic profiles. *Proteins* 2008, 70:344-352.
58. MCL - a cluster algorithm for graphs.. [<http://micans.org/mcl/>].
59. Li L, Stoeckert CJ Jr, Roos DS: OrthoMCL: identification of ortholog groups for eukaryotic genomes. *Genome Res* 2003, 13:2178-2189.
60. CAZY - Carbohydrate-Active EnZYmes database.. [<http://www.cazy.org/>].
61. Cantarel BL, Coutinho PM, Rancurel C, Bernard T, Lombard V, Henrissat B: The carbohydrate-active EnZYmes database (CAZy): an expert resource for glycogenomics. *Nucleic Acids Res* 2009, 37:D233-D238.
62. Librado P, Rozas J: DnaSP v5: a software for comprehensive analysis of DNA polymorphism data. *Bioinformatics* 2009, 25:1451-1452.
63. JGI genome portal.. [<http://genome.jgi-psf.org/>].
64. Latgé JP: The cell wall: a carbohydrate armour for the fungal cell. *Mol Microbiol* 2007, 66:279-290.
65. de Groot P, Brandt BW, Horrichi H, Ram AF, de Koster CG, Klis FM: Comprehensive genomic analysis of cell wall genes in *Aspergillus nidulans*. *Fungal Genet Biol* 2009, 46(Suppl 1):S72-S81.
66. Lieckfeldt E, Kullnig CM, Samuels GJ, Kubicek CP: Sexually competent, sucrose- and nitrate-assimilating strains of *Hypocrea jecorina* (*Trichoderma reesei*, Hypocreales) from South American soils. *Mycologia* 2000, 92:374-384.
67. Vargas WA, Mandawe JC, Kenerley CM: Plant-derived sucrose is a key element in the symbiotic association between *Trichoderma virens* and maize plants. *Plant Physiol* 2009, 151:792-797.
68. Martens-Uzunova ES, Schaap PJ: Assessment of the pectin degrading enzyme network of *Aspergillus niger* by functional genomics. *Fungal Genet Biol* 2009, 46(Suppl 1):S170-S179.
69. Beme S, Lah L, Sepčić K: Aegerolysins: structure, function, and putative biological role. *Protein Sci* 2009, 18:694-706.
70. Goodrich-Blair H, Clarke DJ: Mutualism and pathogenesis in *Xenorhabdus* and *Photorhabdus*: two roads to the same destination. *Mol Microbiol* 2007, 64:260-268.
71. Hares MC, Hinchliffe SJ, Strong PC, Eleftherianos I, Dowling AJ, French-Constant RH, Waterfield N: The *Yersinia pseudotuberculosis* and *Yersinia pestis* toxin complex is active against cultured mammalian cells. *Microbiology* 2008, 154:3503-3517.
72. Karasova D, Havlickova H, Sisak F, Rychlík I: Deletion of *sodCI* and *spvBC* in *Salmonella enterica* serovar *Enteritidis* reduced its virulence to the natural virulence of serovars *Agona*, *Hadar* and *Infantis* for mice but not for chickens early after infection. *Vet Microbiol* 2009, 139:304-309.
73. McNulty C, Thompson J, Barrett B, Lord L, Andersen C, Roberts IS: The cell surface expression of group 2 capsular polysaccharides in *Escherichia coli*: the role of *KpsD*, *RhsA* and a multi-protein complex at the pole of the cell. *Mol Microbiol* 2006, 59:907-922.
74. Altschul SF, Gish W, Miller W, Myers EW, Lipman DJ: Basic local alignment search tool. *J Mol Biol* 1990, 215:403-410.
75. SignalP 3.0 Server.. [<http://www.cbs.dtu.dk/services/SignalP/>].
76. Brotman Y, Biff E, Viterbo A, Chet I: Role of swollenin, an expansin-like protein from *Trichoderma*, in plant root colonization. *Plant Physiol* 2008, 147:779-789.
77. Max Planck Institute of Developmental Biology: Bioinformatics toolkit. [<http://toolkit.tuebingen.mpg.de/blastclust/>].
78. Talbot NJ: Growing into the air. *Curr Biol* 1997, 7:R78-R81.
79. Wösten HA, van Wetter MA, Lugones LG, van der Mei HC, Busscher HJ, Wessels JG: How a fungus escapes the water to grow into the air. *Curr Biol* 1999, 9:85-88.
80. Kubicek CP, Baker S, Gamauf C, Kenerley CM, Druzhinina IS: Purifying selection and birth-and-death evolution in the class II hydrophobin gene families of the ascomycete *Trichoderma/Hypocrea*. *BMC Evol Biol* 2008, 8:4.
81. Viterbo A, Chet I: TasHyd1, a new hydrophobin gene from the biocontrol agent *Trichoderma asperellum*, is involved in plant root colonization. *Mol Plant Pathol* 2006, 7:249-258.
82. Djonovic S, Pozo MJ, Dangott LJ, Howell CR, Kenerley CM: Sm1, a proteinaceous elicitor secreted by the biocontrol fungus *Trichoderma virens* induces plant defense responses and systemic resistance. *Mol Plant Microbe Interact* 2006, 19:838-853.
83. Djonovic S, Vargas WA, Kolomiets MV, Horndeski M, Wiest A, Kenerley CM: A proteinaceous elicitor Sm1 from the beneficial fungus *Trichoderma virens* is required for induced systemic resistance in maize. *Plant Physiol* 2007, 145:875-889.
84. Rep M: Small proteins of plant-pathogenic fungi secreted during host colonization. *FEMS Microbiol Lett* 2005, 253:19-27.
85. Mukherjee PK, Hadar R, Pardovitz-Kedmi E, Trushina N, Horwitz BA: MRSP1, encoding a novel *Trichoderma* secreted protein, is negatively regulated by MAPK. *Biochem Biophys Res Commun* 2006, 350:716-722.
86. Annaleo D, Gross SR: Structural studies on *Neurospora* RNA polymerases and associated proteins. *J Biol Chem* 1985, 260:16174-16180.
87. Vogels 50x salts. [<http://www.fgsc.net/methods/vogels.html>].
88. Jones JGD, Dunsmuir P, Bedbrook J: High-level expression of introduced chimaeric genes in regenerated transformed plants. *EMBO J* 1985, 4:2411-2418.
89. Berrocal-Tito G, Sametz-Baron L, Eichenberg K, Horwitz BA, Herrera-Estrella A: Rapid blue light regulation of a *Trichoderma harzianum* photolyase gene. *J Biol Chem* 1999, 274:14288-14294.
90. Dettler JC, Jett JM, Lucas SM, Dalin E, Arellano AR, Wang M, Nelson JR, Chapman J, Lou Y, Rokhsar D, Hawkins TL, Richardson PM: Isothermal strand displacement amplification applications for high-throughput genomics. *Genomics* 2002, 80:691-698.
91. Huang X, Madan A: CAP3: A DNA Sequence Assembling Program. *Genome Res* 1999, 9:868-877.
92. Papadopoulos JS, Agarwala R: COBALT: constraint-based alignment tool for multiple protein sequences. *Bioinformatics* 2007, 23:1073-1079.

doi:10.1186/gb-2011-12-4-r40

Cite this article as: Kubicek et al: Comparative genome sequence analysis underscores mycoparasitism as the ancestral life style of *Trichoderma*. *Genome Biology* 2011 12:R40.

The *Trichoderma atroviride* photolyase-encoding gene is transcriptionally regulated by non-canonical light response elements

Mayte G. Cervantes-Badillo¹, Tania Muñoz-Centeno¹, Edith E. Uresti-Rivera¹, Gerardo R. Argüello-Astorga¹ and Sergio Casas-Flores¹

IPICYT, Division de Biología Molecular, San Luis Potosí, Mexico

Keywords

BLR proteins; blue light; light response element; *phr-1*; *Trichoderma*

Correspondence

S. Casas-Flores, IPICYT, Division de Biología Molecular, Camino a la presa San José No. 2055, Colonia Lomas 4a sección n, C.P. 78216, San Luis Potosí, Mexico
Fax: +52 444 8342010
Tel: +52 444 8342046
E-mail: scasas@ipicyt.edu.mx

(Received 14 February 2013, revised 28 April 2013, accepted 21 May 2013)

doi:10.1111/febs.12362

The BLR-1 and BLR-2 proteins of *Trichoderma atroviride* are the *Neurospora crassa* homologs of white collar-1 and -2, two transcription factors involved in the regulation of genes by blue light. BLR-1 and BLR-2 are essential for photoinduction of *phr-1*, a photolyase-encoding gene whose promoter exhibits sequences similar to well-characterized light regulatory elements of *Neurospora*, including the albino proximal element and the light response element (LRE). However, despite the fact that this gene has been extensively used as a blue light induction marker in *Trichoderma*, the function of these putative regulatory elements has not been proved. The described LRE core in *N. crassa* comprises two close but variably spaced GATA boxes to which a WC-1/-2 complex binds transiently upon application of a light stimulus. Using 5' serial deletions of the *phr-1* promoter, as well as point mutations of putative LREs, we were able to delimit an ~ 50 bp long region mediating the transcriptional response to blue light. The identified light-responsive region contained five CGATB motifs, three of them displaying opposite polarity to canonical WCC binding sites. Chromatin immunoprecipitation experiments showed that the BLR-2 protein binds along the *phr-1* promoter in darkness, whereas the application of a blue light pulse results in decreased BLR-2 binding to the promoter. Our results suggest that BLR-2 and probably BLR-1 are located on the *phr-1* promoter in darkness ready to perform their function as transcriptional complex in response to light.

Introduction

Light is an important environmental cue to which organisms respond in many different ways. Filamentous fungi are able to adapt their physiology to light signals to induce morphogenetic pathways [1]. Blue light regulates photoconidiation, phototropism, entrainment and resetting of circadian rhythms, carotenoid synthesis, sexual and asexual development, among other processes [1–3]. For decades, the filamentous fungus *Neurospora crassa* has been the classical model system to study blue light signal transduction. In this fungus, the white collar (WC) -1 and WC-2 proteins mediate all known responses to blue light [4–6]. Both proteins contain PER-ARNT-SIM (PAS) domains for protein–protein interactions, and GATA type Zn-finger DNA binding domains. WC-1 functions as a blue light photoreceptor by means of its special-

ous fungus *Neurospora crassa* has been the classical model system to study blue light signal transduction. In this fungus, the white collar (WC) -1 and WC-2 proteins mediate all known responses to blue light [4–6]. Both proteins contain PER-ARNT-SIM (PAS) domains for protein–protein interactions, and GATA type Zn-finger DNA binding domains. WC-1 functions as a blue light photoreceptor by means of its special-

Abbreviations

APE, albino proximal element; BLR, blue light regulator; BLRC, BLR complex; ChIP, chromatin immunoprecipitation; ELRE, early LRE; LLRE, late LRE; LOV, light, oxygen and voltage; LRE, light response element; PAS, PER-ARNT-SIM; PDA, potato dextrose agar; PLRR, potential light response region; TSS, transcription start site; UCR, upstream conserved region; WC, white collar; WCC, WC complex.

BIBLIOGRAFÍA

- Ahmad, M., y Cashmore, A.R.** (1993). HY4 gene of *A. thaliana* encodes a protein with characteristics of a blue-light photoreceptor. *Nature* **366**:162–166.
- Ballario P, Talora C, Galli D, Linden H y Macino G.** (1998). Roles in dimerization and blue light photoresponse of the PAS and LOV domains of *Neurospora crassa* white collar proteins. *Mol Microbiol* **29**:719-729.
- Ballario, P., Vittorioso, P., Magrelli, A., Talora, C., Cabibbo, A. y Macino G.** (1996). White collar-1, a central regulator of blue light responses in *Neurospora*, is a zinc finger protein. *EMBO J* **15**: 1650-1657.
- Berger, S. L., B. Piña, N. Silverman, G. A. Marcus, J. Agapite, J. L. Regier, S. J. Triezenberg, y L. Guarente.** (1992). Genetic isolation of ADA2: a potential transcriptional adaptor required for function of certain acidic activation domains. *Cell* **70**:251–265.
- Berrocal-Tito, G. M., Esquivel-Naranjo, E. U., Horwitz, B. A. y Herrera-Estrella, A.** (2007). *Trichoderma atroviride* PHR1, a fungal photolyase responsible for DNA repair, autoregulates its own photoinduction. *Eukaryot. Cell* **6**:1682-1692.
- Berrocal-Tito, G., Sametz-Baron, L., Eichenberg, K., Horwitz, B. A. y Herrera-Estrella, A.** (1999). Rapid blue light regulation of a *Trichoderma harzianum* photolyase gene. *J Biol Chem.* **274**:14288–14294.
- Bertrand C., Benhamed M., Li Y, Ayadi M., Lemonnier G., Renou J., Delarue M. y Zhou D.** (2005). Arabidopsis HAF2 Gene Encoding TATA-binding Protein (TBP)-associated Factor TAF1, Is Required to Integrate Light Signals to Regulate Gene Expression and Growth. *J. Biol. Chem.* **280**:1465–1473.

- Brenna A, Grimaldi B, Filetici P y Ballaríoa P.** (2012). Physical association of the WC-1 photoreceptor and the histone acetyltransferase NGF-1 is required for blue light signal transduction in *Neurospora crassa*. *Mol Biol Cell* **23**:3863-72.
- Briggs WR, y Huala E.** (1999). Blue-light photoreceptors in higher plants. *Annu. Rev. Cell. Dev. Biol.* **15**:33-62.
- Briggs, W. R. y Christie, J. M.** (2002). Phototropins 1 and 2: versatile plant blue light receptors. *Trends Plant Sci* **7**:204-210.
- Brownell, J. E., and C. D. Allis.** (1995). An activity gel assay detects a single, catalytically active histone acetyltransferase subunit in *Tetrahymena* macronuclei. *Proc. Natl. Acad. Sci. USA* **92**:6364–6368.
- Brownell, J. E., J. Zhou, T. Ranalli, R. Kobayashi, D. G. Edmondson, S. Y. Roth, y Allis C. D..** (1996). *Tetrahymena* histone acetyltransferase A: a transcriptional co-activator linking gene expression to histone acetylation. *Cell* **84**:843–851.
- Bubner B y Baldwin IT.** (2004). Use of real-time PCR for determining copy number and zygosity in transgenic plants, *Plant Cell Rep* **23**, 263–271.
- Candau, R., P. A. Moore, L. Wang, N. Barlev, C. Y. Ying, C. A. Rosen, y Berger S. L..** (1996). Identification of human proteins functionally conserved with the yeast putative adaptors ADA2 and GCN5. *Mol. Cell. Biol* **16**:593– 602.
- Carattoli, A., Romano, R., Ballarío, P., Morelli, G. y Macino, G.** (1991). The *Neurospora crassa* carotenoid biosynthetic gene (albino 3) reveals highly conserved regions among prenyltransferases. *J Biol Chem* **266**:5854–5859.

- Casas-Flores y Herrera Estrella.** (2013). The Influence of Light on the Biology of Trichoderma. Trichoderma: Biology and Applications © CAB International. (eds P.K. Mukherjee et al.).
- Casas-Flores, S., Rios-Momberg, M., Bibbins, M., Ponce-Noyola, P. y Herrera-Estrella,** (2004). BLR-1 and BLR-2 are key regulatory elements for photoconidiation and mycelial growth in *T. atroviride*. *Microbiology* **150**: 3561-3569.
- Cashmore, A. R.** (2003). Cryptochromes: Enabling plants and animals to determine circadian time. *Cell*. **114**:537–543.
- Cerdá-Olmedo E.** (2001). Phycomyces and the biology of light and color. *FEMS Microbiol Rev.* **25**: 503-12.
- Cervantes-Badillo Mayte Guadalupe, Muñoz-Centeno Tania, Uresti-Rivera Edith Elena, Argüello-Astorga Gerardo Rafael y Casas-Flores Sergio.** (2013). The *Trichoderma atroviride* photolyase-encoding gene is transcriptionally regulated by non-canonical light response elements. *FEBS J.*
- Corrochano LM, y Garre V.** (2010). Photobiology in the Zygomycota: multiple photoreceptor genes for complex responses to light. *Fungal Genet Biol* **47**:893-9.
- Chen Hui, DeMayb Bradley S., Gladfelterb Amy S., Dunlap Jay C. y Loros Jennifer.** (2010). Physical interaction between VIVID and white collar complex regulates photoadaptation in *Neurospora*. *J. Proc Natl Acad Sci.* **107**:16715-20.
- Cheng, M., Chory, J. y Fankhauser, C.** (2004). Light signal transduction in higher plants. *Annu. Rev. Genet* **38**:87-117.

- Cheng, P., Yang, Y., Gardner, K. H. y Liu, Y.** (2002). PAS domain-mediated WC1/WC2 interaction is essential for maintaining of steady-state level of WC-1 and of function of both proteins in circadian clock and light responses of *Neurospora*. *Mol. Cell. Biol* **22**:517-524.
- Cheng, P., Yang, Y., Wang, L., He, Q. y Liu, Y.** (2003). WHITE COLLAR-1, multifunctional *Neurospora* protein involved in the circadian feedback loops, light sensing a transcription repression of *wc-2*. *J. Biol. Chem* **278**: 3801-3808.
- Cheung, P., Allis, C. D., y Sassone-Corsi, P.** (2000). Signaling to chromatin through histone modifications. *Cell* **103**:263–271.
- Demarsy Emilie y Fankhauser Christian.** (2009). Higher plants use LOV to perceive blue light. *Curr Opin Plant Biol.* **12**:69-74.
- Dyda, F., Klein, D. C., y Hickman, A. B.** (2000). GCN5-related N-acetyltransferases: a structural overview. *Annu. Rev. Biophys. Biomol. Struct.* **29**:81–103.
- Fletcher, T.M. y Hansen, J.C.** (1995) Core Histone Tail Domains Mediate Oligonucleosome Folding and Nucleosomal DNA Organization Through Distinct Molecular Mechanisms. *J. Biol. Chem.* **270**:25359-25362.
- Folta Kevin M y Maruhnich Stefanie A.** (2007). Green light: a signal to slow down or stop. *J. Exp. Bot.* **58**:3099–3111.
- Friedl, M.A., Kubicek, C.P. y Druzhinina, I.S.** (2008a). Carbon source dependence and photostimulation of conidiation in *Hypocrea atroviridis*. *Applied and Environmental Microbiology* **74**:245–250.

- Friedl, M.A., Schmoll, M., Kubicek, C.P. y Druzhinina, I.S.** (2008b) Photostimulation of *Hypocrea atroviridis* growth occurs due to a cross-talk of carbon metabolism, blue light receptors and response to oxidative stress. *Microbiology*. **154**:1229–1241.
- Froehlich, A. C., Liu, Y., Loros, J. J. y Dunlap J. C.** (2002). White collar-1, a circadian blue light photoreceptor, binding to the *frequency* promoter. *Science* **297**: 815-819.
- Gehring, W y Rosbash, M.** (2003). The coevolution of blue-light photoreception and circadian rhythms. *J. Mol. Evol.* **57**:S286–S289.
- Georgakopoulos, T., y G. Thireos.** (1992). Two distinct yeast transcriptional activators require the function of the GCN5 protein to promote normal levels of transcription. *EMBO J.***11**:4145–4152.
- Glomset, J. A., Gelb, M. H. y Farnsworth, C. C.** (1990). Prenyl proteins in eukaryotic cells: a new type of membrane anchor. *Trends Biochem Sci.* **15**:139–142.
- Green CD, y Han JD** (2011). Epigenetic regulation by nuclear receptors. *Epigenomics*. **3**:59–72.
- Gresik, M., Kolarova, N. y Farkas, V.** (1988). Membrane potential, ATP, and cyclic AMP changes induced by light in *Trichoderma viride*. *Exp. Mycol.* **12**:295-301.
- Gresik, M., Kolarova, N. y Farkas, V.** (1989). Light-stimulated phosphorylation of proteins in cell free extracts from *Trichoderma viride*. *FEBS Lett.* **12**:185-187.

- Grewal, S. I. S., M. J. Bonaduce, y A. J. S. Klar.** (1998). Histone deacetylase homologs regulate epigenetic inheritance of transcriptional silencing and chromosome segregation in fission yeast. *Genetics*. **150**:563-576.
- Grimaldi, B., Coiro, P., Filetici, P., Berge, E., Dobosy, J. R., Freitag, M., Selker, E. U y Ballario, P.** (2006). The *Neurospora crassa* White Collar-1 dependent blue light response requires acetylation of histone H3 lysine 14 by NGF-1. *Mol. Biol. Cell*. **17**:4576-4583.
- He, Q., y Liu, Y.** (2005). Molecular mechanism of light responses in *Neurospora*: from light-induced transcription to photoadaptation. *Genes Dev*. **19**: 2888-2899.
- He, Q., Cheng, P., Yang, Y., Wang, L., Gardner, K. H. y Liu, Y.** (2002). White collar-1, a DNA binding transcription factor and a light sensor. *Science* **297**: 840-843.
- Herrera-Estrella, A. y Horwitz, B.** (2007). Looking through the eyes of fungi: molecular genetics of photoreception. *Mol. Microbiol* **64**: 5-15.
- Hettmann, C., y D. Soldati.** (1999). Cloning and analysis of a *Toxoplasma gondii* histone acetyltransferase: a novel chromatin remodelling factor in *Apicomplexan* parasites. *Nucleic Acids Res*. **27**:4344–4352.
- Hong, L., G. P. Schroth, H. R. Matthews, P. Yau, y E. M. Bradbury.** (1993). Studies of the DNA binding properties of histone H4 amino terminus: thermal denaturation studies reveal that acetylation markedly reduces the binding constant of the H4 “tail” to DNA. *J. Biol. Chem*. **268**:305–314.

- Horwitz, B. A., Gressel, J., y Malkin, S.** (1985). Photoperception mutants in *Trichoderma*: mutants that sporulate in response to stress but not light. *Curr. Genet.* **9**: 605-613.
- Howe L, Auston D, Grant P, John S, Cook RG, Workman JL, y Pillus L.** (2001). Histone H3 specific acetyltransferases are essential for cell cycle progression. *Genes Dev.* **3**:3144–3154.
- Idnurm, A., y Heitman, J.** (2005). Light controls growth and development via a conserved pathway in the fungal kingdom. *PLoS Biol* **3**: e95.
- Ikegami S., Ooe Y., Shimizu T., Kasahara T., Tsuruta T., y Kijima, M.** (1993). Accumulation of multiacetylated forms of histones by trichostatin A and its developmental consequences on early starfish embryos. *Roux's Arch. Dev. Biol.* **202**:144–151.
- Iseki, M., Matsunagas, S., Murakamik, A., Ohno, K., Shiga, K., Yoshida, K., Sugai, M., Takahashil, T., Hori, T. y Watanabe, M.** (2002). A blue-light-activated adenylyl cyclase mediates photoavoidance in *Euglena gracillis*. *Nature* **415**:1047-1051.
- Ito Kazuhiro, Charron Catherine E y Adcock Ian M.** (2007). Impact of protein acetylation in inflammatory lung diseases. *Pharmacology & Therapeutics.* **116**: 249–265.
- Jenuwein T y Allis C.** (2001). Translating the histone code, *Science* **293**: 1074–80.
- Jiang P, Hu Q, Ito M, Meyer S, Waltz S, Khan S, Roeder RG, y Zhang X.** (2010). Key roles for MED1 LxxLL motifs in pubertal mammary gland development and luminal-cell differentiation. *Proc Natl Acad Sci USA* **107**:6765–6770.

- Jiao, Y., Lau, O. S. y Deng, X. W.** (2007). Light-regulated transcriptional networks in higher plants. *Nat. Rev. Genet.* **8**:217-230.
- Kaufman, L.** (1993). Transduction of blue light signals. *Plant Physiol.* **102**:333–337.
- Klein RM.** (1992). Effects of green light on biological systems. *Biol Rev Camb Philos Soc.* **2**:199-284
- .
- Ko, W. H., Nash, A. I. y Gardner, K. H.** (2007). A LOVely view of blue light photosensing. *Nat. Chem. Biol.* **3**:372-374.
- Kraus, P. R., C. B. Nichols, y J. Heitman.** (2005). Calcium and calcineurin-independent roles for calmodulin in *Cryptococcus neoformans* morphogenesis and high-temperature growth. *Eukaryot. Cell* **4**:1079–1087.
- Kumagai, T.** (1989), Temperature and myochrome system in near-uv light inducible and blue light reversible photoinduction of conidiation in *Alternaria tomato*. *Photochemistry and Photobiology.* **50**: 793–798.
- Li, L., Wright, S.J., Krystofova, S., Park, G. y Borkovich, K.A.** (2007). Heterotrimeric G proteins signaling in filamentous fungi. *Annual Review of Microbiology* **61**:423–452.
- Lilly, V.G. and Barnett, H.L.** (1951). *Physiology of the Fungi*. McGraw-Hill Book Company Inc., USA.
- Linden, H. y Macino, G.** (1997). White collar 2, a partner in blue-light signal transduction, controlling expression of light-regulated genes in *Neurospora crassa*. *EMBO J.* **16**: 98-109.

- Linden, H., Ballario, P. y Macino, G.** (1997). Blue light regulation in *Neurospora crassa*. *Fungal Genet. Biol.* **22**: 141-150.
- Lledias F, Hansberg W.** (2000). Catalase modification as a marker for singlet oxygen. *Methods Enzymol.* **319**:110-9.
- Ma, L., Li, J., Qu, L., Hager, J., Chen, Z., Zhao, H. & Deng, X. W.** (2001). Light control of *Arabidopsis* development entails coordinated regulation of genome expression and cellular pathways. *Plant Cell.* **13**:2589–2607.
- Makki Mohammad, Shahidul, Heinz Thorsten y Englert Christoph.** (2008). TSA downregulates Wilms tumor gene 1 (*Wt1*) expression at multiple levels. *Nucleic Acids Research.* **36**:4067–4078.
- Marcus, G. A., N. Silverman, S. L. Berger, J. Horiuchi, y L. Guarente.** (1994). Functional similarity and physical association between GCN5 and ADA2: putative transcriptional adaptors. *EMBO J.* **13**:4807–4815.
- Mooney, J.L., y Yager, L.N.** (1990). Light is required for conidiation in *Aspergillus nidulans*. *Genes Dev* **4**:1473–1482.
- Mukherjee, P.K. y Kenerley, C.M.** (2010). Regulation of morphogenesis and biocontrol properties in *Trichoderma virens* by a VELVET protein, Vel1. *Appl. and Environ. Microbiol.* **76**:2345–2352.
- Nagy, F. y Schäfer, E.** (2000). Nuclear and cytosolic events of light-induced, phytochrome-regulated signaling in higher plants. *EMBO J* **19**: 157-163.
- Naruse, Y., Oh-hashii, K., Iijima, N., Naruse, M., Yoshioka, H. y Tanaka, M.** (2004). Circadian and light-induced transcription of clock gene *per1* depends on histone acetylation and deacetylation. *Mol. Cell. Biol.* **24**:6278-6287.

- O'Meara Teresa R., Hay Christie, Price Michael S., Giles Steve, y Alspaugh J. Andrew.** (2010). *Cryptococcus neoformans* Histone Acetyltransferase Gcn5 Regulates Fungal Adaptation to the Host Eukaryotic Cell. **9**:1193–1202
- Purschwitz, J., Muller, S., Kastner, C., y Fischer, R.** (2006). Seeing the rainbow: light sensing in fungi. *Curr Opin Microbiol.* **9**: 566–571.
- Rau, W. & Mitzka-Schnabel, U.** (1985). Carotenoid synthesis in *Neurospora crassa*. *Methods Enzymol* **110**: 253–267.
- Rosales-Saavedra, T., Esquivel-Naranjo, E.U., Casas- Flores, S., Martinez-Hernandez, P., Ibarra-Laclette, E., Cortes-Penagos, C., y Herrera-Estrella, A.** (2006). Novel light-regulated genes in *Trichoderma atroviride*: a dissection by cDNA microarrays. *Microbiology.* **152**: 3305–3317.
- Savkur RS, Burris TP (2004).** The coactivator LXXLL nuclear receptor recognition motif. *J Pept Res* **63**:207–212.
- Schäfer E y Nagy F.** (2006). Photomorphogenesis in Plants and Bacteria: Function and Signal Transduction Mechanisms. 3rd edition, Springer, The Netherlands.
- Schmoll, M., Franchi, L., y Kubicek, C.P.** (2005). Envoy, a PAS/LOV domain protein of *Hypocrea jecorina* (Anamorph *Trichoderma reesei*), modulates cellulase gene transcription in response to light. *Eukaryot. Cell* **4**: 1998-2007.
- Schmoll, M., Schuster, A., Silva, R.N. y Kubicek, C.P.** (2009). The G-alpha protein GNA3 of *Hypocrea jecorina* (anamorph *Trichoderma reesei*) regulates cellulase gene expression in the presence of light *Eukaryot Cell* **8**:410–420.
- Schwerdtfeger, C. y Linden, H.** (2003). VIVID is a flavoprotein and serves as a fungal blue light photoreceptor for photoadaptation. *EMBO J.* **22**: 4846-4855.

- Selker Eric U.** (1998). Trichostatin A causes selective loss of DNA methylation in *Neurospora*. *Proc. Natl. Acad. Sci.* **95**: 9430–9435.
- Silverman, N., J. Agapite, y L. Guarente.** (1994). Yeast ADA2 protein binds to the VP16 protein activation domain and activates transcription. *Proc. Natl. Acad. Sci. USA.* **91**:11665–11668.
- Smith, E. R., J. M. Belote, R. L. Schiltz, X. J. Yang, P. A. Moore, S. L. Berger, Y. Nakatani, y C. D. Allis.** (1998). Cloning of *Drosophila* GCN5: conserved features among metazoan GCN5 family members. *Nucleic Acids Res.* **26**:2948–2954.
- Sterner, D.E. y Berger, S.L.** (2000). Acetylation of histones and transcription-related factors. *Microbiol. Mol. Biol. Rev.* **64**:435–459.
- Strahl B y Allis C.** (2000). The language of covalent histone modifications, *Nature* **403**: 41–5.
- VanDemark AP, Kasten MM, Ferris E, Heroux A, Hill CP, Cairns BR.** (2007). Autoregulation of the rsc4 tandem bromodomain by gcn5 acetylation. *Mol Cell* **27**: 817–828.
- Vlachonasios KE, Thomashow MF y Triezenberg SJ.** (2003). Disruption mutations of ADA2b and GCN5 transcriptional adaptor genes dramatically affect *Arabidopsis* growth, development, and gene expression.
- Walter Gehring y Michael Rosbash** (2003). The Coevolution of Blue-Light Photoreception and Circadian Rhythms. *J Mol Evol.* **57**:S286–S289.

- Washburn, B. K. y Esposito, R. E.** (2001). Identification of the Sin-3-binding site in Umc6 defines a two-step process for conversion of Ume6 from a transcriptional repressor to an activator in yeast. *Mol. Cell. Biol.* **21**:2057-2069.
- Wolfe AP y Hayes JJ.** (1999). Chromatin disruption and modification. *Nucleic Acids Res.* **27**:711-20.
- Workman, J.L., y Kingston, R.E.** (1998). Alteration of nucleosome structure as a mechanism of transcriptional regulation. *Annu. Rev. Biochem.* **67**: 545–579.
- Xu, W., D. G. Edmondson, y S. Y. Roth.** (1998). Mammalian GCN5 and P/CAF acetyltransferases have homologous amino-terminal domains important for recognition of nucleosomal substrates. *Mol. Cell. Biol.* **18**:5659–5669.
- Zhang, W., Bone, J.R., Edmondson, D.G., Turner, B.M., y Roth, S.Y.** (1998). Essential and redundant functions of histone acetylation revealed by mutation of target lysines and loss of the Gcn5p acetyltransferase. *EMBO J.* **17**: 3155–3167.