

This article may be downloaded for personal use only. Any other use requires prior permission of the author or publisher.

The following article appeared in *Results in Physics*, 7: 4278-4286 (2017); and may be found at <https://doi.org/10.1016/j.rinp.2017.10.055>

© 2017. This manuscript version is made available under the CC-BY-NC-ND 4.0 license <http://creativecommons.org/licenses/by-nc-nd/4.0/>

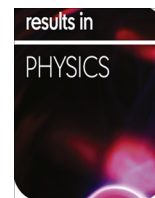

Magnetic matrices used in high gradient magnetic separation (HGMS): A review



Wei Ge^{a,b}, Armando Encinas^{b,*}, Elsie Araujo^b, Shaoxian Song^{c,*}

^aSchool of Resources and Environmental Engineering, Wuhan University of Technology, Luoshi Road 122, Wuhan, Hubei 430070, China

^bDivision de Materiales Avanzados, Instituto Potosino de investigación Científica y Tecnología, Camino a la Presa San José 2055, San Luis Potosí C.P. 78216, Mexico

^cHubei Key Laboratory of Mineral Resources Processing and Environment, Luoshi Road 122, Wuhan, Hubei 430070, China

ARTICLE INFO

Article history:

Received 19 September 2017

Received in revised form 27 October 2017

Accepted 27 October 2017

Available online 31 October 2017

Keywords:

Magnetic matrix

HGMS

Review

ABSTRACT

HGMS is effective in separating or filtering fine and weakly magnetic particles and widely applied in mineral processing, water treatment, cell and protein purification. The magnetic matrix is a crucial device used in magnetic separator to generate high magnetic field gradient and provide surface sites for capturing magnetic particles. The material, geometry, size and arrangement of the matrix elements can significantly affect the gradient and distribution of the magnetic field, and the separating or filtering performance. In this paper, the researches and developments of magnetic matrices used in HGMS are reviewed.

© 2017 The Authors. Published by Elsevier B.V. This is an open access article under the CC BY-NC-ND license (<http://creativecommons.org/licenses/by-nc-nd/4.0/>).

Introduction

Magnetic separation is a method to selectively separate and concentrate magnetic materials based on the differences in magnetic properties between particles. Conventional magnetic separators are restricted to separate strong magnetic materials with particle size larger than 50 μm [1–3]. However, the appearance of high gradient magnetic separator designed by Jones based on the concept of combining a strong magnetic field with a magnetic matrix (ferromagnetic material) placed between the magnetic poles proposed by Frantz, greatly extended the application of magnetic separation to fine and weakly magnetic particles [4]. Due to its high selectivity, high efficiency, environmental friendliness and economic advantages, HGMS has been a widely applied method of separating or filtering fine and weakly magnetic particles from fluid suspensions. Now it is widely used in many fields such as mineral processing industry for concentration of magnetic ores and purification of clay, coal and quartz, water purification and biotechnological field for purification of cell, protein and DNA [5–11].

High magnetic field gradient is a crucial factor in HGMS process which can be described as a separation process or a deep-bed filtration process in which a magnetic matrix is magnetized and used to bundle the external magnetic field in its vicinity to generate

high magnetic field gradient [12]. In the presence of strong magnetic field, paramagnetic and ferromagnetic particles can be strongly captured by the magnetized matrix when passing through it. A simplified diagram of high gradient magnetic separation process is shown in Fig. 1. Moreover, the captured magnetic particles on the matrix surfaces can be easily dislodged by rinsing when the applied magnetic field is reduced to zero.

The magnetic force (F_m) acting on a paramagnetic particle of volume (v_p) in a magnetic field (H) is given by the function (1)

$$F_m = \mu_0 \chi v_p H \nabla H \quad (1)$$

where μ_0 is the vacuum permeability, χ is the volume magnetic susceptibility of the particle, and ∇H is the gradient of the magnetic field at the position of the particle. The magnetic force F_m is proportional to the volume of magnetic particle, magnetic susceptibility, magnetic field intensity and its gradient. The former two factors are determined by the magnetic material to be captured. The latter two factors are related to the magnet and matrix of the separator. For a given magnetic particle, the magnetic force can be strengthened by two methods: increasing the magnetic field intensity H and the magnetic field gradient ∇H . In HGMS both variables are adopted to increase the magnetic force. However, increasing the magnetic field intensity can also result in higher system cost or higher energy consumption. Therefore, increasing the magnetic field gradient by optimization of the magnetic matrix is a complementary strategy to attain higher separation efficiency. The common magnetic matrices are grooved plates, steel balls, steel rods, expanded metal, woven wire mesh and steel wool. Some typical

* Corresponding authors.

E-mail addresses: armando.encinas@ipicyt.edu.mx (A. Encinas), ssx851215@whut.edu.cn (S. Song).

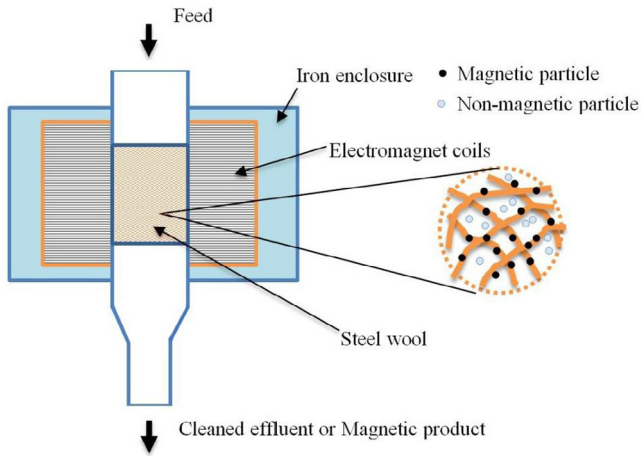

Fig. 1. Schematic diagram of HGMS process.

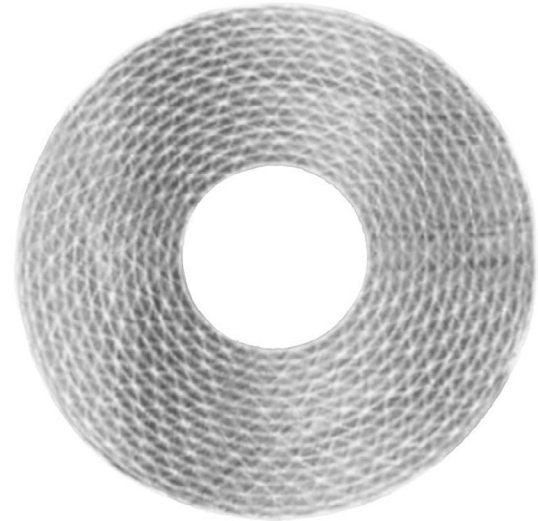

Fig. 2. Magnetic screen matrix.

values of the magnetic field gradient generated by using matrix in magnetic separators are shown in Table 1 [13]. The magnetic field gradients in matrix separators are much greater than that of non-matrix separator and steel wool has the highest magnetic field gradient as high as 2.5×10^4 T/m. The magnetic matrix used in high gradient magnetic separator not only generates the high magnetic field gradient to increase magnetic force acting on magnetic particle, but also provides surface sites with high gradient to collect magnetic material. The matrix can significantly influence the processing capacity, separation efficiency and operation cost. The magnetic field distribution and its gradient depend on the material, shape, size, arrangement and placement of the matrix elements [14–18].

With the purpose of improving separation performance and extending its application fields, a considerable amount of research has carried out to study matrix materials, geometries, magnetic field distribution around matrix element and capture performance, which are very beneficial to the matrix development [19]. However, there is few review articles about the research of magnetic matrix in HGMS. In this paper, the researches and developments focused on the magnetic matrix in HGMS system are reviewed.

Magnetic matrix

Since the advent of the first high gradient magnetic separator, HGMS has attracted considerable attention, and through the development up to current technologies, many different types of high gradient magnetic separation systems as well as different kinds of matrix have been invented and employed [3]. The use of a magnetic matrix in magnetic separation systems is earlier than the invention of high gradient magnetic separator, and at that time it was only used to capture ferromagnetic particles. The earliest magnetic matrix used in the magnetic separator invented by Frantz [20] in 1937 is magnetic screen made up of thin metal strips with sharp edges to attract and hold the magnetic particles in dry or wet separation [21], as shown in Fig. 2. Magnetic balls with high permeability were used as magnetic matrix in a columnar form to

remove ferrous magnetic particles from a fluid by Leslie [22] in 1948, and in 1968 the ball matrix was first used to capture weakly magnetic particles [23]. Grooved plates with triangular tooth as shown in Fig. 3, combined with Jones high-intensity magnetic separator were used to capture ferromagnetic particles in 1967 [24–26]. In order to capture feebly magnetic particles, randomly oriented steel wool used as matrix combined with high-intensity magnetic separator, which is an extension of Frantz’s concept, was used by Kolm for separating magnetic colloidal and sub-colloidal ceramic particles in 1971 [27].

Thereafter, the development of magnetic matrix was focused on increasing saturation magnetization by optimization of material composition, and increasing magnetic field gradient and capture performance by optimization of geometry and arrangement.

In recent decades, in order to separate or filter nanoparticles in biological field, some miniature magnetic matrices made up of ordered thin wires or films were developed by sophisticated

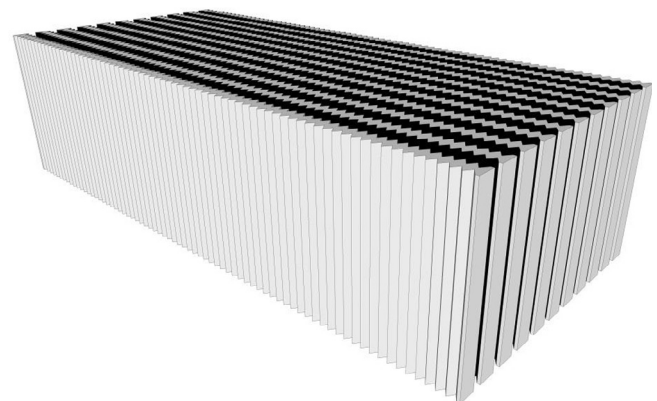

Fig. 3. Magnetic matrix of grooved plates.

Table 1
Magnetic field gradients generated in magnetic separator [13].

Magnetic separator	Non-matrix separator	Matrix separator			
		Grooved plates	Expanded metal	Steel balls	Steel wool
Magnetic field gradient (T/m)	<200	2×10^3	4×10^3	1×10^3	2.5×10^4

process of microfabrication technology, and the matrices are very different from conventional magnetic matrices in size and structure [28,29].

Materials of the magnetic matrix

The magnetic matrix employed to generate high magnetic field gradient and capture weakly magnetic particles requires material with high permeability, as well as good corrosion and abrasion resistance. These properties are determined by the matrix material and are closely related to the separation performance, and service time [2,19]. At the same external background induction, magnetic wires with a higher saturation magnetization can have a higher magnetic induction in its vicinity than that of wires with a lower saturation magnetization [30]. However, with increasing distance from the surface of matrix element, the difference in magnetic induction between materials with different saturation magnetization shrinks, and for wire or rod matrix at a distance three times of the wire or rod diameter, the difference is negligible [31].

As for the material research, much attention was paid to improve the performance of iron based alloys by changing compositions or contents. Due to its high permeability, iron based soft magnetic materials such as pure iron, low carbon steel, ferritic stainless steel and some other iron-bearing alloys have been used to fabricate magnetic matrix. However, because of its poor wear and corrosion resistance, pure iron and carbon steel were abandoned, although they have good magnetic permeability.

The chromium ferritic alloy called Cr17 stainless steel containing Cr 17.31%, Fe 81.64% used to fabricate stainless steel wool in America in 1979, has good corrosion and abrasion resistances as well as a high saturation magnetization as high as 1.2 T. Other materials such as alloy of Cr13, Cr15 and stainless steel 420 were also used to fabricate steel wool or metal mesh [32,33]. In consideration of the advantages of high toughness, good electromagnetic properties, abrasion and corrosion resistance, iron based amorphous alloys were first used to fabricate magnetic matrices in 1981, and the main compositions of the alloy are Fe, Co, Ni, Cr, P and B [34,35]. Due to slow degradation of magnetization characteristic in frequent reversals of the magnetic field, work-hardened 316L austenitic stainless wire was restricted to applications where magnetic field reversals are seldom required [36]. Magnetic stainless steel 16CrFe invented by Shanxi Iron and Steel Institute and Shanghai Iron and Steel Institute, contained Fe 83.59%, Cr 16.17%, Mn 0.15%, C 0.01% [37]. It has good processability, high magnetic permeability. Permalloy (Fe 19%, Ni 81%) matrix was used to capture metallic copper (Cu_2O , CuO), and high efficiencies larger than 90% were attainable under proper conditions in 2010 [38]. Iron-cobalt alloy with excellent performances of a high intensity of saturated magnetic induction as high as 2.38 T, high hardness, abrasion and corrosion resistances, was invented by Guangdong Iron and Steel Institute as a magnetic matrix in 2011 [39]. Besides Fe, Co, the alloy also contains small amounts of Cr, Mo, Nb and Ce to improve its magnetic and mechanical properties, and Ni is deposited on its surface to enhance corrosion resistance. Now ferritic stainless steel is the most widely used material for magnetic matrix fabrication [2,40]. In addition to iron-based alloys, magnetite-silica composite matrix with magnetite particle size from 0.2 to 1 μm , pure nickel and aluminum were also used [41–43].

Geometry of the magnetic matrix

An excellent matrix should have maximum collection efficiency, large capture area per volume, enough magnetic field gradient and minimum fluid impedance, and these properties are

sensitive to its geometrical conditions of shape, size and filling factor [38].

The generated magnetic field gradient in the vicinity of the matrix is inversely proportional to the diameter of the matrix element. With increase of the diameter of the matrix element, the area (see in Fig. 8) of strong magnetic field increases and the magnetic field gradient decreases. Conversely, with decrease of the diameter of the matrix element, the area of strong magnetic field decreases and the magnetic field gradient increases. This is because the smaller the cross-section diameter of the magnetic element, the greater the curvature of the surface of the matrix element, the more obvious the cusp magnetic effect [44]. This effect can be well illustrated by Table 2 which shows the magnitude of a magnetic gradient as a function of distance R , from the center of a ferromagnetic wire for round wires of different diameters with an internal magnetization per unit volume M at $10\text{ T}/4\pi$ [45]. The magnetic force acting on magnetic particle can be maximized by using a fine matrix. However, correct choice of the matrix for selective separation needs the size of the matrix element to be compatible with the size distribution of particles to be separated [46]. On the one hand, the magnetic force should be strong enough to capture the magnetic particles. On the other hand, the magnetic force cannot be too strong to cause the matrix blockage and mechanical entrapment of the non-magnetic component into the magnetic fraction.

Typical filling factors of various matrices are shown in Table 3 [47]. Because matrices with low filling factor cannot conduct the magnetic flux very well, strong external magnetic field is required to magnetize them. Therefore, the background magnetic induction for magnetizing steel wool to saturation is much larger than that of bulk steel [48].

For steel wool matrix, the fibers are randomly oriented and compressed to a density sufficiently high to provide a multiplicity of regions of high magnetic field gradient. Because of the cusp magnetic effect, in addition to cylinder, the fibrous long wire also can be rectangular or ribbon in shape with diameter between 0.03 and 0.20 mm.

In the case of the same sectional area, compared with sectional shapes of hexagon and eight sides, the matrices with sectional shapes of triangle and rectangle can generate higher magnetic field gradients and have similar depths of magnetic force. Considering the effective capture area, steel wool with rectangular cross-section is more efficient [49].

Expanded metal matrices generally have elements with diamond-shaped grids and diamond-shaped sections. The magnetic field near the surface of the element changes drastically, resulting in high magnetic field gradient. The effective collection area of expanded metal is larger than that of the grooved plates and steel balls. Because of the smaller element size of the expanded metal, the lower capture size limit of weakly magnetic particle size can be as small as 10 μm . However, the fluidic resistance of the expanded metal is larger than that of the grooved plate and the ball matrix.

The triangular or salient tooth of grooved plates can effectively gather the magnetic field lines and increase the magnetic field intensity. The width of the gaps between the plates should be 1.5–2 times larger than the maximum particle size [50]. Because the gap is often too large to ensure sufficient recovery of weakly fine magnetic particles, and a decrease in the width of the gap caused rapid clogging of the matrix, grooved plates are more suitable for coarse magnetic materials. The selections of tooth angle, pole pitch and teeth pitch of grooved plate, should take into account the magnetic force and collection area [51]. When the tooth angle was 66°, the magnetic force and magnetic induction intensity of the tooth tip were very high [52]. In view of the problem that a very uneven distribution of the magnetic force in the air

Table 2
Magnitude of the magnetic field gradient as a function of distance R from the center of a ferromagnetic wire for round wires of different diameters [45].

Distance from wire center	Diameter of wire				
	0.2 μm grad B (T/cm)	2.0 μm grad B (T/cm)	20 μm grad B (T/cm)	200 μm grad B (T/cm)	2000 μm grad B (T/cm)
0.1 μm	600,000	–	–	–	–
0.2 μm	75,000	–	–	–	–
0.5 μm	4800	–	–	–	–
1.0 μm	600	60,000	–	–	–
2.0 μm	75	7500	–	–	–
5.0 μm	4.8	480	–	–	–
10.0 μm	0.6	60	6000	–	–
20.0 μm	0.075	7.5	750	–	–
50.0 μm	0.0048	0.48	48	–	–
0.10 mm	0.0006	0.06	6.0	600	–
0.20 mm	0.000075	0.0075	0.75	75	–
0.50 mm	0.0000048	0.00048	0.048	4.8	–
1.0 mm	–	0.00006	0.006	0.6	60
2.0 mm	–	–	0.00075	0.075	7.5
5.0 mm	–	–	0.000048	0.0048	0.48

Table 3
Filling factors of various matrices [47].

Matrix	Filling factor
Steel wool	0.01–0.06
Expanded metal	0.12–0.28
Wire mesh	0.15–0.25
Spheres	0.50–0.64
Grooved plates	0.50–0.85

gap of the conventional grooved plate, changing the triangular valleys into trapezoidal valleys can increase the collection ability for fine particles [53].

Ball matrix is very regular and uniform in its structure, the separation or filtering action can be uniform. And in the absence of external magnetic field, the rolling of balls leads to strong anti-blocking ability, high speed of unloading, conservation of washing water and power conservation [22,54]. In magnetic separation, the magnetic field gradient and capture performance can be optimized by using balls with appropriate diameters. However, ball matrix is not popular in commercial application. The reason might be that the relatively small spherical curvature results in a limited magnetic field gradient and the effective capture area is not large.

Some matrices with special cross section shapes or surfaces showed better performance than circular cross-section matrix in capturing fine particles. Steel wool with discontinuous collection sites on surface can be used to separate more-magnetic particles from less-magnetic particles [55]. As shown in Fig. 4 nickel dendrites deposited on an existing stainless steel wool or stainless

steel netting are able to capture very dilute levels of paramagnetic nanoparticles and the dendrites contain a high number of capture sites for paramagnetic particles [56]. Spiral rod with thread shaped protrusions as shown in Fig. 5a [57] and rhombus cross-section rod matrix in Fig. 5b, with ratio of long to short diagonal from 2:1 to 3:2 [58] can generate a higher magnetic field gradient than that of the round rod and can recover weakly magnetic particles with particle size as small as 5 μm ; while the merit of large capture area of the round rod is maintained.

Placement and arrangement of the magnetic matrix

In practical applications, how the matrix is placed in the separation chamber and how the matrix elements are arranged can affect the suspension flow through the matrix and the distribution of the magnetic field in the matrix [59]. The placement and arrangement of the matrix are closely related to the separation performance.

Ferromagnetic wires are usually packed into a very open and porous structure such as a grid, chaotic tangle or ordered structure with regular arrangement. Steel wool is often packed into a net with a chaotic tangle structure at a certain filling factor, for periodic or continuous operation [60]. Due to irregular structures, complex geometries of steel wool, use of a single large centralized inlet and outlet can lead to non-uniform flow velocities, serious blockage, uneven distribution of slurry and severe wear and abrasion at points where the flow is directed to the matrix. These disadvantages are also closely related to the structure of the matrix. To

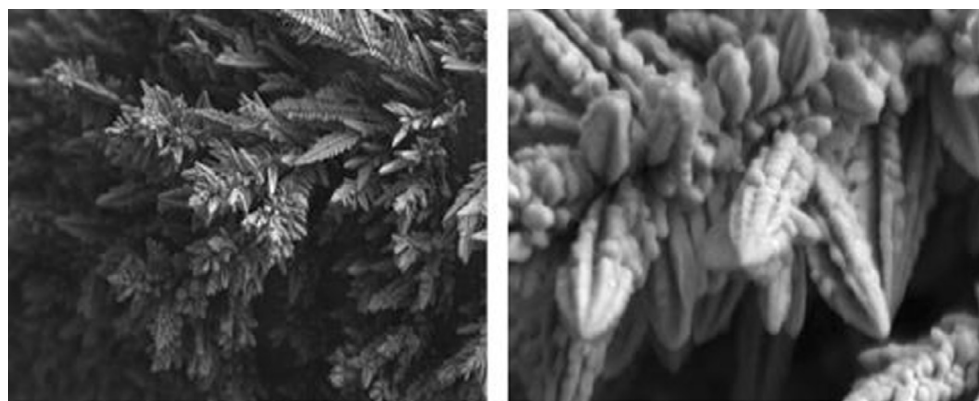

Fig. 4. Nickel dendrites deposited on steel wool surface [55].

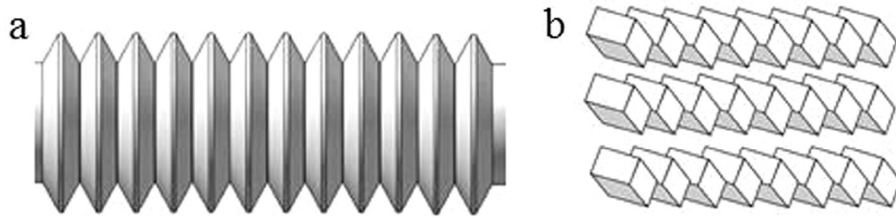

Fig. 5. Matrix of spiral rod (a) and rhombus cross-section rod (b).

overcome the shortcomings of using a single large centralized inlet and outlet, a multiple matrix assembly comprising a plurality of magnetic matrices arranged longitudinally in a stacked array are designed. Each matrix is fed by a number of inlets and had its product collected by a number of outlets [61]. In this matrix, the magnetic flux is uniformly distributed throughout the magnetic separation area, and the slurry to be separated is uniformly distributed throughout the magnetic separation area. The matrix can remove large amounts of highly magnetic material without clogging and can be easily cleaned.

To reduce physical blocking and strengthen the capture performance of steel wool, the matrix could be made up of alternate layers of expanded metal with stainless steel wool sandwiched between them [62]. Each alternate layer of expanded metal had its longitudinal axis at right angles to the longitudinal axis of the adjacent layer.

Expanded metal screens are usually placed with their planes perpendicular to the flow direction. Arrangement with screen planes screen parallel to the flow direction and to the field is an exception [63]. This arrangement permits unimpeded passage of nonmagnetic particles as large as 3 mm and at the same time, recovers the ferromagnetic particles in thin sheets and reduces the entrainment of nonmagnetic materials within flocs of ferromagnetic particles.

Compared to a disordered matrix, an ordered matrix can be easily cleaned, the filling factor is constant throughout the entire volume and the fluid velocity varies little. For an ordered rod matrix, there are three possible arrangements: longitudinal (L), transversal (T) and axial (A) configuration as shown in Fig. 6. For a longitudinal configuration, the fluid flow and the magnetic field are parallel with each other and perpendicular to the wires. In a transversal configuration, the wires, the fluid flow and the magnetic field are reciprocally perpendicular. For an axial configuration, the flow and the wires are parallel and transversal to the magnetic field. Compared to the other configurations, because the fluid flow and the magnetic field are parallel with each other, the process capacity of the high gradient magnetic separator in the longitudinal configuration can be increased by increasing the

flow cross section and width of the magnet without increasing the width of the air gap [64].

Strictly periodically ordered matrix offer a distinct advantage over matrix where this order is less strict, as the ordering of the rods has a significant influence in the separation efficiency. In practical applications, arrangement of rod elements plays a decisive role in the magnetic field distribution and in the movement of particles in the matrix, thus having a significant influence on the matrix performance [65]. For steel rods, there are two often applied arrangements, a rectangular lattice arrangement and a rhombic lattice arrangement shown in Fig. 7 [66]. The steel rods with the same diameter arranged into a rectangular lattice have higher magnetic field intensity and gradient than that of the same rods arranged into a rhombic lattice. In a rhombic lattice arrangement, the surface of the rods has a better contact with the slurry, and the collision probability of particles on rod increases [67]. In the transverse configuration, the saturation mass of an ordered matrix consisting of parallel wire decreases with decreasing inclination angle between wire and magnetic field. For an inclination angle α , the saturation mass is $m(\alpha) = m_{sp} \sin(2\alpha)$, where m_{sp} is the saturation mass value obtained for $\alpha = 90^\circ$ (wires perpendicular to the magnetic field) [68]. The separation performance of steel rods also can be improved by several ways, such as adjusting the magnetic field orientation, increasing layers of the steel rods, using steel rods with an appropriate diameter, using a combination of rods with different diameters or different cross section shapes in a certain arrangement [69–72].

An arrangement that both axes of the ferromagnetic wires and the separation chamber with multiple outlets are perpendicular to the magnetic field, is called repulsive mode [73]. In the repulsive mode, diamagnetic particles in the slurry are attracted toward the wires and paramagnetic particles are repelled from the wires. This results in the increase in concentration of the magnetic particles at one region within the slurry and depletion in concentration of the magnetic particles at another region of the slurry [74,75]. Increasing the length of the rods can provide higher material throughput as well as increased selectivity. The process is continuous and has the advantage that the material throughput rate

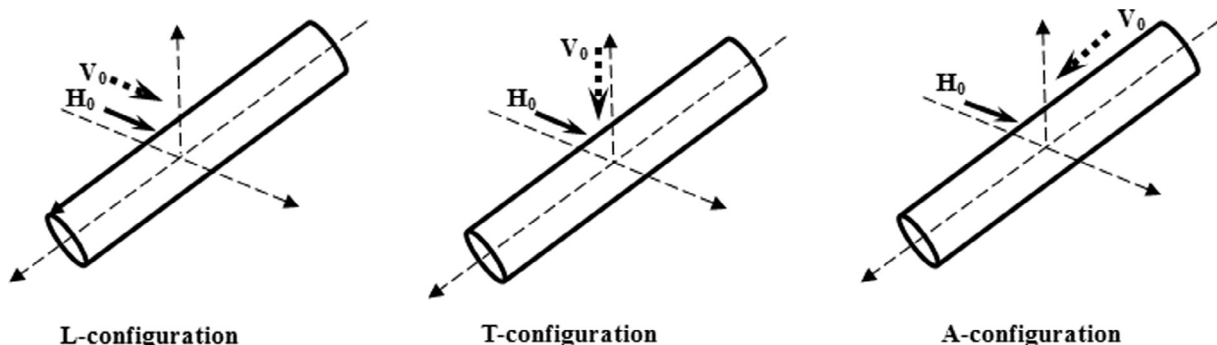

Fig. 6. Three configurations of rod matrix in HGMS.

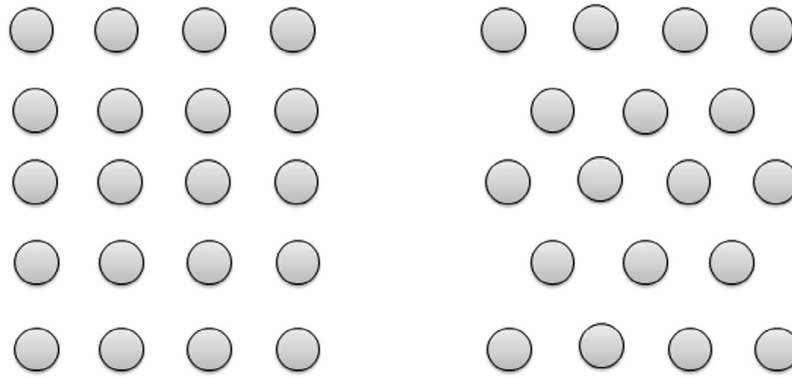

Fig. 7. Arrangements of rectangular lattice (left) and rhombic lattice (right).

and the product grade can be increased simultaneously, and stable separation without clogging is feasible [76].

For magnetic matrix of grooved plates, the plates are disposed parallel to each other and spaced apart to each other by nonmagnetic spacers in a direction perpendicular to the magnetic field. Sometimes the plates are obliquely placed at an angle in the range 5° – 45° to the horizontal. A small inclination can assist the suspension to flow through and result in a low rate of the suspension through the plates giving a high recovery of the magnetic particles. A larger inclination gives a fast flow with a decrease in the recovery of magnetic particles [77].

Magnetic field of the magnetic matrix

The magnetic field of the matrix is defined by the magnitude of magnetic field gradient and its distribution in the vicinity of magnetic element and in the matrix. The magnetic field gradient and its distribution are affected by the geometry, arrangement and placement of the matrix elements and it is an important factor that needs to be taken into consideration for improving separation performance by matrix optimization. The investigations of magnetic field in magnetic matrix are mainly carried out by magnetic simulation.

For a ferromagnetic wire or rod in a homogeneous field transverse to its axis, the surfaces in the direction of the magnetic field have the highest magnetic field intensity and positive magnetic field gradients, and on the other two side surfaces, the magnetic field intensities are weak and the magnetic field gradients are neg-

ative [78], as shown in Fig. 8. A decrease in diameter of the matrix element can increase the magnetic field gradient without changing the relative distribution of the magnetic field. After reaching the magnetic saturation, the magnetic field intensity around the matrix with high saturation magnetization, is larger than that of the matrix with low saturation magnetization. However, the magnetic field gradient doesn't change significantly with the increase in background induction [31]. This suggests that increasing the magnetic field intensity blindly may not necessarily improve the separation performance in practical use.

The magnetic field intensity and gradient around a sharp corner of the magnetic matrix are related to the angle between the sharp corner and the magnetic field. When the bisector of the sharp angle is parallel to the direction of the field, the intensity and gradient of the field around the corner is greatest. As the angle of the bisector of the sharp angle increases from 0° to 90° , the intensity and gradient of the magnetic field gradually decrease to the minimum [79].

For a matrix of circular rods with its axis transverse to the external magnetic field, the distributions of magnetic field on the surfaces are consistent with that of a single wire. There is no obvious difference in the magnetic field intensity distribution between circular rod groups in a rectangular lattice and in rhombic lattice arrangement, respectively. However, the uniformity of the magnet field in a rhombic lattice arrangement is better than that in rectangular one, which is beneficial for improving the recovery of magnetic particles [44]. The magnetic induction intensity of the matrix of rods with rhombic cross section mixed with circular ones is obviously higher than that of a matrix only containing rods with rhombic cross section. Rods with elliptic cross section can induce large magnetic field intensity and magnetic field gradient than the rod with circular matrix [80].

The investigations of the magnetic field characteristics were mainly concentrated on a single-wire or rod aiming at maximizing the magnetic force as large as possible and applying these rules to multi-collector matrix. However, in practical applications, the magnetic matrix usually contains a group of elements, and the study of a single element may not reflect the real situation of the actual matrix. More researches on the magnetic field distribution of the matrix in the form of a group of element are required.

Capture of magnetic particles in the magnetic matrix

Particle trajectory models were often used to study the capture of magnetic particles by the matrix. The earliest models mainly focused on the oversimplified analysis of a small paramagnetic particle trajectories in the vicinity of a single magnetized wire to describe the dynamic particle motion and to obtain the capture

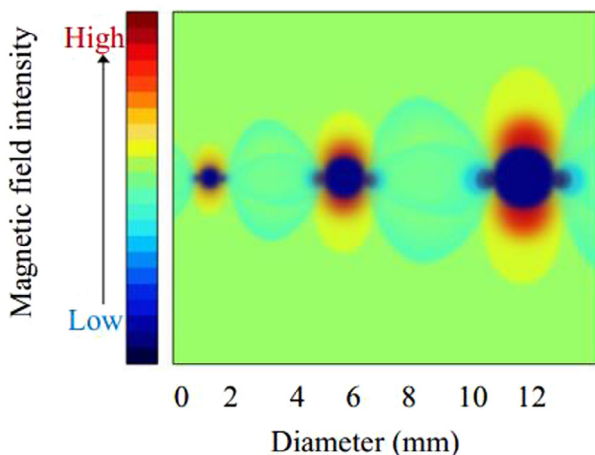

Fig. 8. Magnetic field distributions of magnetic rod with different diameters.

radius for evaluation of capture performance. In a longitudinal configuration as shown in Fig. 9, a ferromagnetic wire of radius a and saturation magnetization M_s , placed axially along the z axis. A uniform magnetic field (H_0), large enough to saturate the wire, is applied in the x direction. Spherical paramagnetic particles of susceptibility χ , volume V_p ($R \ll a$), and density ρ_p are carried by a fluid of viscosity η that flows with uniform velocity v_0 in the negative x direction. Motion equations describing the particle motion in terms of polar coordinate r_a , θ , and z are given by functions (2) and (3) [81].

$$\frac{dr_a}{dt} = \left(\frac{V_0}{a}\right) \left(1 - \frac{1}{r_a^2}\right) \cos\theta - \left(\frac{V_m}{a}\right) \left(\frac{M_s}{2\mu_0 H_0}\right) \frac{1}{r_a^5} - \left(\frac{V_m}{a}\right) \frac{\cos 2\theta}{r_a^3} \quad (2)$$

$$r_a \frac{d\theta}{dt} = -\left(\frac{V_0}{a}\right) \left(1 + \frac{1}{r_a^2}\right) \sin\theta - \left(\frac{V_m}{a}\right) \frac{\sin 2\theta}{r_a^3} \quad (3)$$

where

$$r_a = \frac{x}{a \cos\theta} = \frac{y}{a \sin\theta} \quad (4)$$

and magnetic velocity

$$V_m = \frac{2\chi M_s H_0 R^2}{9\eta a} \quad (5)$$

The values of R_c as a function of V_m/V_0 can be obtained by these equations. If time is eliminated from Eqs. (2) and (3), particle trajectories can be described by an equation of a general form [82]

$$\frac{1}{r_a} \frac{dr_a}{d\theta} = F\left(\frac{V_m}{V_0}, \frac{M_s}{2\mu_0 H_0}, r_a, \theta\right) \quad (6)$$

The path taken by the particle depends only on V_m/V_0 , $M_s/2H_0$, the initial position and the initial velocity. The effective capture cross-section per unit length of wire $2R_c$ depends only on V_m/V_0 and not V_m or V_0 separately. The dependence of R_c upon the V_m/V_0 can be divided into two categories: at low values of V_m/V_0 , the R_c increases linearly V_m/V_0 . While at large values, it increases

approximately as $R_c \sim \left(\frac{V_m}{V_0}\right)^{1/3}$ and the ratios of V_m/V_0 range from 0.1 to 400 [83].

In the axial configuration, the accumulation radius R_a as a function of time is expressed by the equation $R_a^n = At + 1$. The exponent n and the coefficient A depend on the flow concentration and magnetic field. The value of n varies from 3 to 4.

Observations by television system showed that the particle capture is a dynamic process, involving simultaneously the capture and the wash-off of the particles, and as the layer of attracted particles grows the magnetic attractive force decreases until the magnetic attractive force is equilibrium with the competing force [84,85].

The dynamic analysis of weakly magnetic particles in a high gradient magnetic field of cylindrical rod magnetic matrix by Xiong [86] showed that the acceleration of magnetic particles caused by magnetic force near the surface of the rod is much larger than that of the particles caused by the pulsation of the pulp or vibration of the matrix. The capture time of the magnetic particles is no more than 5 ms, which is much smaller than the pulsation or vibration period. Therefore, the vibration of the matrix and the pulsation of the pulp have little effect on the recovery of magnetic particles.

In the longitudinal configuration, the magnetic forces are attractive near the upstream and downstream sides of the wire and repulsive near the other sides. The particles are mainly captured on the upstream side. A finite accumulation also occurs at the downstream side of the wire. For ultra-fine particles, it is the fluid flow that is responsible for the downstream particle capture. Because of the negative magnetic gradient on the side surface, paramagnetic particles are kept away from the matrix element, and the mass flux is zero. In the transverse configuration, the particle build-up profiles, both upstream and downstream, depend on the slurry velocity. At low flow velocity the particles collect on the upstream side of the wire. As the flow velocity increases, particles also collect on the downstream side, and at a high velocity the particles do not collect on the upstream side at all.

The conclusions of the capture on a single wire are useful for understanding the dynamics of the capture in the vicinity of an isolated magnetized element, their validity for a real matrix is very limited, this is because the magnetic matrix is composed of a plurality of matrix elements. Therefore, the investigation of particle capture in a real matrix needs to take into account the interactions between matrix elements. But there are only a few researches on this problem. Okada [87] studied the capture of simple configuration in two kinds of arrangements: a rectangular lattice arrangement and a rhombic lattice arrangement. In a multi-wire matrix, enough large area facing the incoming fluid is still the main factor which affects the capture efficiency. Since the particles deposit preferentially on the upstream wires, the wire matrix tends to saturate with particles in the upstream part. The downstream wires capture a decreasing amount of particles, because these wires are in a fluid wake that is partially depleted of particles. Below the Mason number (ratio of viscous to magnetic forces) the particle is captured irrespective of its initial position in the array. Above this number, particle capture is only partially successful and depends on the particle's entry position [88].

In theoretical models of particle capture by a magnetized wire, the idealized scenario is considered in which the collection wire axis was oriented orthogonally to the magnetic field direction. However, the magnetic field produced by a group of rods or wires is different from the one produced by a single rod, and the particle need not be attracted to the rod surface, it is brought there by the flow. In this sense, the models developed for simulating and understanding the capture of magnetic particles in matrix are restrictive and limited and cannot reflect the real conditions of the capture process to an appropriate degree [89].

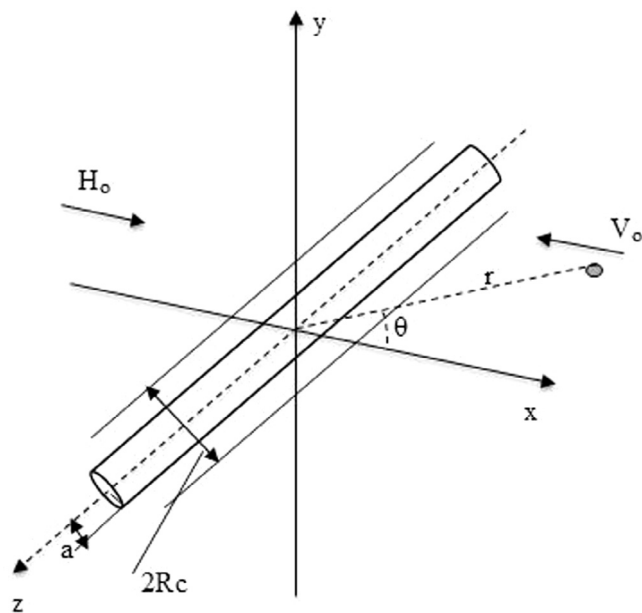

Fig. 9. A ferromagnetic wire of radius a , placed axially along the z axis, in a uniform magnetic field H_0 applied in the x direction, interacts with a paramagnetic particle of radius R in moving fluid. The fluid flows past the wire with a velocity V_0 in the negative x direction [81]

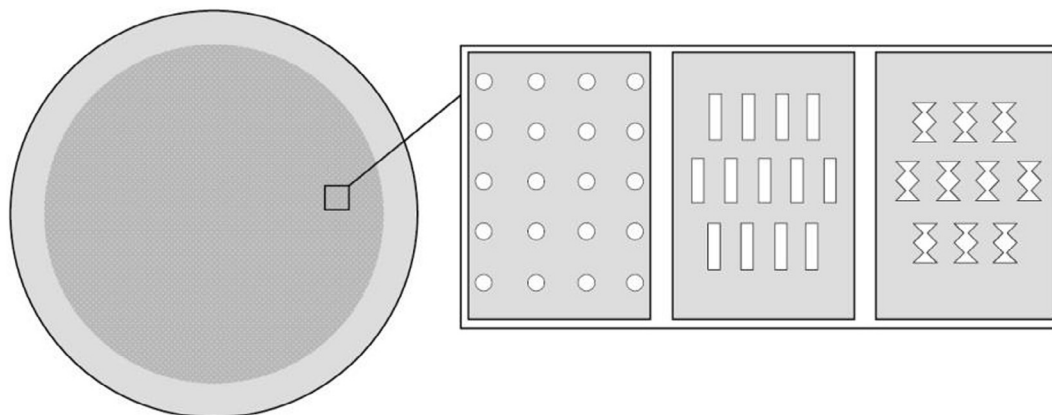

Fig. 10. Ferromagnetic membrane matrix with different pore shapes.

Micro magnetic matrix

In recent decades some micro magnetic separation devices with new designs of matrix were developed to capture superfine magnetic particles especially used in biomedical field. These micro magnetic matrices are fabricated by a series of sophisticated and expensive processes and their dimensions are in micro level, much smaller than that of conventional magnetic matrices. Due to micro size of the structure, the disadvantage is that only a small amount of suspension can be filtered at a low rate. But also because of its micro structure with ordered arrangement, the micro matrix can be used to capture superfine magnetic particles less than 50 nm with high selectivity. According to their geometries, the matrices can be divided into micro-wire, micro-pillar and micro-membrane magnetic matrix.

For micro-wire magnetic matrix, the integrating soft magnetic wires of 5 μm thick and 20 μm wide are placed at the bottom or at both sides of the separating channel with their long axis perpendicular to the channel [90,91]. The spacing between the wires is 20 μm .

In micro-pillar magnetic matrix, the soft pillar arrays are vertically incorporated on the bottom and ceiling of the separation chamber [92]. The diameter and height of the pillar are 20 μm and 25 μm , respectively, and the spacing between is 20 μm .

Ferromagnetic membranes with surfaces having different shapes of perforations also is called magnetic sifter. Three different perforation shapes are shown in Fig. 10. The thickness of the membrane is about 4 μm and the diameters of the circular holes can be 20 or 50 μm [29]. The dimension of rectangles perforation is 15 \times 45 μm , and the dimension of bowtie perforation is 36 \times 45 μm [93].

Summary

Currently, some excellent materials for fabricating magnetic matrix have been invented. Numerous researches on geometry, placement, arrangement and magnetic field of the matrix have led to a well understanding of how these parameters can be beneficial for design and optimization of the matrix. Though a lot of theoretical studies on calculation of particle trajectories around wires have been done, there is still a lack of understanding about the dynamic capture of the magnetic matrix, and more innovative theoretical researches involving this complicate process are needed.

Due to the large demand for applications requiring the filtration of superfine magnetic particles in different fields and economic advantages, ordered micro matrices that can generate much higher magnetic field gradients, which can be easily fabricated need to be developed.

Acknowledgements

The Consejo Nacional de Ciencia y Tecnología (CONACYT) of Mexico is gratefully acknowledged for offering Wei Ge the PhD scholarship No. 785987. E. Araujo thanks Fondo CONACYT-Secretaría de Energía – Sustentabilidad Energética. The financial supports to this work from the Natural Science Foundation of Hubei Province of China (2016CFA013) and Wuhan Science and Technology Bureau (2016070204020156) were gratefully acknowledged. In this paper some figures were taken from other papers, the authors are gratefully acknowledged.

References

- [1] Oberteuffer J. High gradient magnetic separation. *IEEE T Magn* 1973;9:303–6.
- [2] Oder R. High gradient magnetic separation theory and applications. *IEEE T Magn* 1976;12:428–35.
- [3] Svoboda J, Fujita T. Recent developments in magnetic methods of material separation. *Miner Eng* 2003;16:785–92.
- [4] Kelland D. High gradient magnetic separation applied to mineral beneficiation. *IEEE T Magn* 1973;9:307–10.
- [5] Yu KC. The removal of iron from hard pulverised kaolin by dry high-gradient magnetic separation. *Magn Electr Sep* 1995;6:171–7.
- [6] Altin G, Inal S, Alp I, Lekili ME. Recovery of Chromite from Processing Plant Tailing by Vertical Ring and Pulsating High-Gradient Magnetic Separation. *International Black Sea Mining & Tunnelling Symposium*; 2016.
- [7] Ha DW, Kwon JM, Baik SK, Lee YJ, Han KS, Ko RK, Sohn MH, Seong KC. Purification of condenser water in thermal power station by superconducting magnetic separation. *Physic C* 2011;471:1530–2.
- [8] Li SQ, Wang MF, Zhu ZA, Wang Q, Zhang X, Song HQ, Cang DQ. Application of superconducting HGMS technology on turbid wastewater treatment from converter. *Sep Purif Technol* 2012;84:56–62.
- [9] Takayasu M, Kelland DR, Minervini JV. Continuous magnetic separation of blood components from whole blood. *IEEE T Appl Supercon* 2000;10:927–30.
- [10] Bucak S, Jones DA, Laibinis PE, Hatton TA. Protein separations using colloidal magnetic nanoparticles. *Biotechnol Progr* 2003;19:477–84.
- [11] Levison PR, Badger SE, Dennis J, Hathi P, Davies MJ, Bruce IJ, Schimkat D. Recent developments of magnetic beads for use in nucleic acid purification. *J Chromatogr A* 1998;816:107–11.
- [12] Shukla AA, Etzel MR, Gadam S. *Process Scale Bioseparations for the Biopharmaceutical Industry*. USA: CRC Press; 2007.
- [13] Svoboda J. *Magnetic Techniques for the Treatment of Materials*. Boston: Kluwer Academic Publishers; 2004. p. 65.
- [14] Iacob G, Ciochina D, Bredeteau O, Iacob G, Ciochina D, Bredeteau O. High gradient magnetic separation ordered matrices. *Eur Cells Mater* 2002;3:167–9.
- [15] Chen L. Effect of magnetic field orientation on high gradient magnetic separation performance. *Miner Eng* 2011;24:88–90.
- [16] Kim YG, Song JB, Yang DG, Lee JS, Park YJ, Kang DH, Lee HG. Effects of filter shapes on the capture efficiency of a superconducting high-gradient magnetic separation system. *Supercond Sci Technol* 2013;26:625–9.
- [17] Takayasu M, Friedlaender F, Hiresaki Y, Kelland D. Matrices for selective diamagnetic HGMS. *IEEE T Magn* 1981;17:2810–2.
- [18] Parker MR. High gradient magnetic separation. *Phys Technol* 1981;45:263–8.
- [19] Luborsky FE. High-field gradient magnetic separation: a review. *AIP Conf Vol Am Inst Phys* 1976:633–8.
- [20] S.G. Frantz, *Magnetic separator*, US. Patent, 1937.
- [21] Svoboda J. *Magnetic Techniques for the Treatment of Materials*. Boston: Kluwer Academic Publishers; 2004. p. 114.

- [22] B.W. Leslie, Magnetic separator, US. Patent, 1948.
- [23] J. H. Carpenter, Magnetic separator, US. Patent, 1968.
- [24] Svoboda J. *Magnetic Techniques for the Treatment of Materials*. Boston: Kluwer Academic Publishers; 2004. p. 98.
- [25] J.G. Henry, Magnetic separators, US. Patent, 1967.
- [26] G.H. JONES, Magnetic separation with washing and scouring means, US. Patent, 1967.
- [27] W.M.W.M. Henry H. Kolm, Magnetic device, US. Patent, 1971.
- [28] B.A. Frazier, K.H. Han, Blood separation systems in micro device format and fabrication methods, US. Patent, 2005.
- [29] Podoyntsyn SN, Sorokina ON, Kovarski AL. High-gradient magnetic separation using ferromagnetic membrane. *J Magn Magn Mater* 2016;397:51–6.
- [30] Svoboda J. *Magnetic Techniques for the Treatment of Materials*. Boston: Kluwer Academic Publishers; 2004. p. 363.
- [31] Svoboda J. *Magnetic Techniques for the Treatment of Materials*. Boston: Kluwer Academic Publishers; 2004. p. 364.
- [32] N. M. Liang, G. J. Kun, C. Li., A kind of velutinous steel wool filling matrix box, CN, Patent, 2012.
- [33] Pereira MLG, Rodrigues D, Pinatti DG. Determination of experimental conditions for HGMS magnetic separation to reduce the inorganic contents in cellulignin catalytic fuel. *IEEE T Appl Supercon* 2003;13:1588–91.
- [34] F.J. Kaneo Mohri, High gradient magnetic separation apparatus, US. Patent, 1981.
- [35] Ohara T. Particle capture theory and experiment on an amorphous magnetic ribbon filter. *IEEE T Magn* 1984;20:436–43.
- [36] Graham MD. A precaution on using 316L stainless wire in hgms matrices. *Magn Sep N* 1986;91–4.
- [37] An S. A discussion on the development of high-gradient magnetic separation in China. *J Kunm Inst Technol* 1994;19:38–45.
- [38] Wu WI, Wu CH, Hong PK, Lin CF. Capture of metallic copper by high gradient magnetic separation system. *Environ Technol* 2011;32:1427–33.
- [39] L. Z. Jian, C. Y. Xin, H. W. Jia, H. K. Hong, A method for preparing iron cobalt alloy and strong magnetic matrix bar, CN. Patent, 2011.
- [40] Svoboda J. High-gradient magnetic separation: a search for a matrix material. *Int J Miner Process* 1981;8:165–75.
- [41] Ritter JA. Retention of iron oxide particles by stainless steel and magnetite magnetic matrix elements in high-gradient magnetic separation. *Sep Sci Technol* 2005;39:2863–90.
- [42] Watson J, Rassi D, Bahaj AS. The recovery of gold and uranium from gold ore leached residues by HGMS. *IEEE T Magn* 1983;19:2136–8.
- [43] Inglis DW, Riehn R, Austin RH, Sturm JC. Continuous microfluidic immunomagnetic cell separation. *Appl Phys Lett* 2004;85:5093–5.
- [44] Yu ZX, Lin LM, Rui C, Na GN. Analysis of factors influencing magnetic field's characteristics in HGMS based on ANSYS. *Metal Mine* 2013;139–43.
- [45] L.W.M.M. Terstappen, P.A. Liberti, Methods for biological substance analysis employing internal magnetic gradients separation and an externally-applied transport force, US. Patent, 2000.
- [46] Aharoni A. Traction force on paramagnetic particles in magnetic separators. *IEEE T Magn* 1976;12:234–5.
- [47] Svoboda J. *Magnetic Techniques for the Treatment of Materials*. Boston: Kluwer Academic Publishers; 2004. p. 383.
- [48] Svoboda J. *Magnetic Techniques for the Treatment of Materials*. Boston: Kluwer Academic Publishers; 2004. p. 64.
- [49] Z.H. Xin A New structure of magnetic matrix for high gradient magnetic separation equipment *J Filtr Separ* 1994 16 20
- [50] Svoboda J. *Magnetic Techniques for the Treatment of Materials*. Boston: Kluwer Academic Publishers; 2004. p. 99.
- [51] Wei GM, Ren WC, Yuan YX. Study on magnetic field characteristics and process parameters of tooth-plate type magnetic matrix. *Metal Mine* 1985;32–7.
- [52] Shun ZY, Liang SC, Juan WH, Yue WF. Experimental study on magnetic separation by conical flux gathering media and optimization of its cone angle. *Min Process Equip* 2012;74–9.
- [53] Ren WC, Wei GM. Research on the existing problems and improvement of conventional gear plate Matrix. *Metal Mine* 1986;33–5.
- [54] C.J. Hall, Magnetic separator, US. Patent, 1968.
- [55] P.G. Marston, I. Wechsler, J.J. Nolan, Magnetic separation method, US Patent, 1975.
- [56] Gorobets SV, Mikhailenko NA. High-gradient ferromagnetic matrices for purification of wastewaters by the method of magnitoelectrolysis. *J Water Chem Technol* 2014;36:153–9.
- [57] Bo LW, He TY, Xin HY, Tao YZ. Effect of magnetic media on performances of high-gradient magnetic separation. *Metal Mine* 2013;105–107:138.
- [58] L. S. Hou, L. Geng, A kind of high gradient magnetic matrix for high-intensity magnetic separator, CN. Patent, 2012.
- [59] Pasteur A, Tippkotter N, Kampeis P, Ulber R. Optimization of high gradient magnetic separation filter units for the purification of fermentation products. *IEEE T Magn* 2014;50:1–7.
- [60] Wu FD, Ying PS, Yuan SZ, Jin C. Development of belt type permanent high gradient magnetic separator. *Ming Metall* 1996:50–3.
- [61] C. John J. Nolan, P.M.G.B. G., Flow control unit for magnetic matrix, US Patent, 1977.
- [62] A.P. William F. Howell, Filter cartridge for a magnetic separator, US Patent, 1975.
- [63] Kelland D, Dobby G, Maxwell E. Efficient HGMS for highly magnetic materials. *IEEE T Magn* 1981;17:3308–10.
- [64] Hayashi S, Mishima F, Akiyama Y, Nishijima S. Development of high gradient magnetic separation system for a highly viscous fluid. *IEEE T Appl Supercon* 2010;20:945–8.
- [65] Ming Z, Quan HJ, Ming XL. Research on the arrangement style of magnetic medium rod of the sss-type vertical ring and pulsating high gradient magnetic separator. *Ming Process Equip* 2009:97–9.
- [66] Chen L, Ding L, Zhang H, Huang J. Slice matrix analysis for combinatorial optimization of rod matrix in PHGMS. *Miner Eng* 2014;58:104–7.
- [67] Chen LZ, Xu GD, Wen SM, Liu SQ, Gao LK. Effect of rod arrangement in matrix on high gradient magnetic separation performance. *Adv Mater Res* 2013;634–638:3351–4.
- [68] Iacob G, Rezelescu N. Experimental observations on the saturation mass in the capture process of an ordered transverse high gradient magnetic separation matrix. *Powder Technol* 1998;97:233–6.
- [69] Ding L, Chen LZ, Zeng JW. Investigation of combination of variable diameter rod elements in rod matrix on high gradient magnetic separation performance. *Adv Mater Res* 2014;1030:1193–6.
- [70] Chen LZ, Yang R, Guan C, Zeng J, Shao Y, Huang L. Enhanced pulsating hgms of fine hematite with combinative rod matrix. *Sep Sci Technol* 2016;51:564–8.
- [71] Chen LZ, Qian Z, Wen S, Huang S. High-gradient magnetic separation of ultrafine particles with rod matrix. *Min Proc Ext Met Rev* 2012;34:340–7.
- [72] Chen YZ, Chen LZ, Liu WB, Zhen YM. Comparative investigation between parallel and perpendicular combination matrices in high gradient magnetic separation. *Min Metall* 2016;4:25–8.
- [73] L.M. Avid R. Kelland, Magnetic separator and method, 1981.
- [74] Y. Wada, K. Yamamoto, O. Tsukamoto, T. Ohara, C. Miyake, S. Mori, Column and method for separating particles in accordance with their magnetic susceptibility, US. Patent, 1995.
- [75] D.R. Kelland, M. Takayasu, Method and apparatus for continuous magnetic separation, US, 1987.
- [76] Hoffmann C, Franzreb M. A novel repulsive-mode high gradient magnetic separator. Part I. Design and experimental results. *IEEE T Magn* 2004;40:456–61.
- [77] Turkenich AM. Theory and performance of a slurry flow in form of a film in the 6ERM–35/315 separator with a high-gradient magnetic field. *Magn Electr Sep* 1996;8:53–60.
- [78] Lei C, Gang WH, Xiang RH. *Simulation Analysis of Influence of Magnetic Medium on Magnetic Field Characteristics*. Beijing: Metallurgical Industry Press; 2014. p. 4.
- [79] Song CC, Ning GH, Yuan ZY, Jing LX, Hui CC, Yao MS. Investigation of the influence of different matrix rotation angles on the surrounding magnetic field in a uniform magnetic field. *Ming Metall Eng* 2014;34:290–4.
- [80] Zheng X, Wang Y, Lu D. Particle capture of elliptic cross-section matrices for parallel stream high gradient magnetic separation. *Compel* 2016;35:187–99.
- [81] Watson JHP. Magnetic filtration. *J Appl Phys* 1973;44:4209–13.
- [82] Watson J. Theory of capture of particles in magnetic high-intensity filters. *IEEE T Magn* 1975;11:1597–9.
- [83] Birss R, Dennis B, Gerber R. Particle capture on the upstream and downstream side of wires in HGMS. *IEEE T Magn* 1979;15:1362–3.
- [84] Cowen C, Friedlaender F, Jaluria R. High gradient magnetic field particle capture on a single wire. *IEEE T Magn* 1975;11:1600–2.
- [85] Friedlaender FJ, Takayasu M, Rettig J, Kentzer C. Particle flow and collection process in single wire HGMS studies. *IEEE T Magn* 1978;14:1158–64.
- [86] Xiong DH. Dynamic analysis of weakly magnetic mineral particles in high gradient magnetic field of rod matrix. *Metal Mine* 1988;8:19–22.
- [87] Okada H, Mitsuhashi K, Ohara T, Whitby ER, Wada H. Computational fluid dynamics simulation of high gradient magnetic separation. *Sep Sci Technol* 2005;40:1567–84.
- [88] Eisenträger A, Vella D, Griffiths IM. Particle capture efficiency in a multi-wire model for high gradient magnetic separation. *Appl Phys Lett* 2014;105:33508.
- [89] Henci V, Jahoda K, Madai E. Analysis of magnetic and hydraulic forces in an oriented real matrix of a high gradient magnetic separator. *Magn Sep N* 1985;1:173–82.
- [90] Lund-Olesen T, Dufva M, Hansen MF. Capture of DNA in microfluidic channel using magnetic beads: increasing capture efficiency with integrated microfluidic mixer. *J Magn Magn Mater* 2007;311:396–400.
- [91] Bu M, Christensen TB, Smistrup K, Wolff A, Hansen MF. Characterization of a microfluidic magnetic bead separator for high-throughput applications. *Sensor Act A-Phys* 2008;145–146:430–6.
- [92] Dong T, Su Q, Yang Z, Karlsen F, Jakobsen H, Egeland EB, Hjelseth S. Fully integrated micro-separator with soft-magnetic micro-pillar arrays for filtrating lymphocytes, International Conference of the IEEE. *Embs* 2010:6522–6.
- [93] Earhart CM, Nguyen EM, Wilson RJ, Wang YA, Wang SX. Designs for a microfabricated magnetic sifter. *IEEE T Magn* 2009;45:4884–7.