

**INSTITUTO POTOSINO DE INVESTIGACIÓN
CIENTÍFICA Y TECNOLÓGICA, A.C.**

POSGRADO EN CIENCIAS APLICADAS

**"Non-coastal Mexican wetlands: waterfowl
representativeness, habitat occupancy, threats,
conservation actions, and research"**

Tesis que presenta

Natalia de Gortari Ludlow

Para obtener el grado de

Doctora en Ciencias Aplicadas

en la opción de

Ciencias Ambientales

Director de la Tesis:

Dr. Leonardo Chapa Vargas

San Luis Potosí, S.L.P., 8 de Agosto de 2014



Constancia de aprobación de la tesis

La tesis "***Humedales mexicanos no costeros: representatividad de aves acuáticas, ocupación del hábitat, acciones de conservación y de investigación***" presentada para obtener el Grado de Doctora en Ciencias Aplicadas en la opción de Ciencias Ambientales fue elaborada por **Natalia de Gortari Ludlow** y aprobada el **ocho de agosto de dos mil catorce** por los suscritos, designados por el Colegio de Profesores de la División de Ciencias Ambientales del Instituto Potosino de Investigación Científica y Tecnológica, A.C.

Dr. Leonardo Chapa Vargas
Director de la tesis

Dr. Arturo De Nova Vázquez
Miembro del Comité Tutorial

Dr. Joel David Flores Rivas
Miembro del Comité Tutorial

Dr. Javier Salgado Ortiz
Miembro del Comité Tutorial

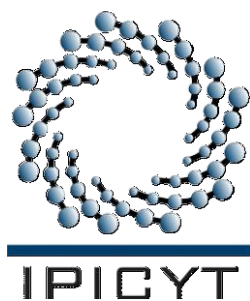

Créditos Institucionales

Esta tesis fue elaborada en la División de Ciencias Ambientales en el Área de Ecología y Cambio Ambiental Global del Instituto Potosino de Investigación Científica y Tecnológica, A.C., bajo la dirección del Dr. Leonardo Chapa Vargas.

Este trabajo fue realizado con el financiamiento de Consejo Potosino de Ciencia y Tecnología (COPOCYT) clave de Proyecto FMSLP-2008-C02-104322, otorgados por el Dr. Leonardo Chapa Vargas.

Durante la realización del trabajo el autor recibió una beca académica del Consejo Nacional de Ciencia y Tecnología (No. 206471).



Instituto Potosino de Investigación Científica y Tecnológica, A.C.

Acta de Examen de Grado

El Secretario Académico del Instituto Potosino de Investigación Científica y Tecnológica, A.C., certifica que en el Acta 026 del Libro Primero de Actas de Exámenes de Grado del Programa de Doctorado en Ciencias Aplicadas en la opción de Ciencias Ambientales está asentado lo siguiente:

En la ciudad de San Luis Potosí a los 8 días del mes de agosto del año 2014, se reunió a las 19:00 horas en las instalaciones del Instituto Potosino de Investigación Científica y Tecnológica, A.C., el Jurado integrado por:

Dr. Javier Salgado Ortiz	Presidente	UMICH
Dr. Leonardo Chapa Vargas	Secretario	IPICYT
Dr. Arturo De Nova Vázquez	Sinodal externo	UASLP
Dr. Joel David Flores Rivas	Sinodal	IPICYT

a fin de efectuar el examen, que para obtener el Grado de:

**DOCTORA EN CIENCIAS APLICADAS
EN LA OPCION DE CIENCIAS AMBIENTALES**

sustentó la C.

Natalia De Gortari Ludlow

sobre la Tesis intitulada:

Humedales mexicanos no costeros: representatividad de aves acuáticas, ocupación del hábitat, acciones de conservación y de investigación

que se desarrolló bajo la dirección de

Dr. Leonardo Chapa Vargas

El Jurado, después de deliberar, determinó

APROBARLA

Dándose por terminado el acto a las 21:45 horas, procediendo a la firma del Acta los integrantes del Jurado. Dando fe el Secretario Académico del Instituto.

A petición de la interesada y para los fines que a la misma convengan, se extiende el presente documento en la ciudad de San Luis Potosí, S.L.P., México, a los 8 días del mes de agosto de 2014.

Mtra. Ivonne Lizette Cuevas Vélez
Jefa del Departamento del Posgrado

Dr. Mañcial Bonilla Marín
Secretario Académico



Dedications

Particularmente quiero externar mi mayor agradecimiento a mi director de tesis, el Dr. Leonardo, quien me tuvo la suficiente paciencia para lograr formarme en el ramo científico y en el trabajo de campo, ya que en un principio mi enfoque estaba mayormente orientado hacia las áreas sociales. Con ambos enfoques (científico y social) el producto del trabajo de tesis fue más integral, sinérgico y enriquecedor. El trabajo fue elaborado en equipo; ya que siempre tuvo disponibilidad de tiempo para sus alumnos, en cuanto a dudas, comentarios y sugerencias siempre estuvo presente.

Asimismo quiero agradecer el apoyo brindado a todo mi comité tutorial que contribuyo al enriquecimiento, fortalecimiento, y conclusión del trabajo de tesis. Al Dr. Javier por su apoyo, sus atinados comentarios y preguntas, y por su disponibilidad de tiempo. Al Dr. Guillermo por fortalecer el trabajo de tesis desde otra perspectiva diferente, pero muy pertinente. Y al Dr. Joel por los comentarios al trabajo, y por todo el material proporcionado, el cual fue muy adecuado para el desarrollo de la tesis. También quiero agradecer a mis amigos y compañeros del IPICYT, con los cuales compartí gratos momentos. Y especialmente gracias a aquellos con los que entablé una relación personal que espero que siga por mucho tiempo. Gracias por sus pláticas, su tiempo, y las experiencias vividas a Gaby, Renato, Heidi, Nieves, Marco, Maritere y Julio.

Asimismo quiero agradecer a mi familia, cuyo apoyo y cariño entrañable, contribuyeron a la fructificación de esta tesis.

Content

Constancia de aprobación de la tesis	iii
Créditos institucionales	iv
Acta de examen	v
Dedications	vi
Content	viii
List of tables	x
List of figures	xiv
Resumen	xv
Abstract	
Presentation and content of the Chapters	1-6
CHAPTER 1. IDENTIFYING CONSERVATION GAPS, OMISSIONS, AND PRIORITIES, FOR MEXICAN NON-COASTAL WATERBIRDS	7
Abstract	8
Resumen	9
Study area	10
Methods	14
Conservation potential of individual sites	15
Similarity among ecoregions	17
Spatial arrangement of PMNCW	17
Potential distribution and protection level	18
Number of aquatic birds species	19
Results	20
Conservation potential of individual sites	20
Similarity among ecoregions	20
Spatial arrangement of PMNCW	23
Potential distribution and protection level	23
Number of aquatic birds species	24
Discussion	27
References	35
CHAPTER 2. THREATS, CONSERVATION ACTIONS, AND RESEARCH WITHIN 78 MEXICAN NON-COASTAL PROTECTED WETLANDS	46
Abstract	47
Resumen	48
Introduction	49

Methods	52
Databases	52
Statistical analysis	55
Results and discussion	58
Conclusions and conservation implications	71
References	73

**CHAPTER 3. HABITAT OCCUPANCY BY WATERBIRDS AT A
WETLAND SYSTEM MODIFIED BY CHANNELIZATION AND
LARGE-SCALE AGRICULTURE: HABITAT TYPE VS.
LANDSCAPE COMPOSITION**

Abstract	83
Resumen	84
Background of the Rioverde Valley	85
Introduction	88
Methods	94
Study region	94
Field work	95
Landscape composition	96
Statistical analysis	97
Statistical modelling	98
Results	100
Discussion	109
Conclusions	113
References	115
General conclusions	125
Appendices	
1. 78 MPNCW and their physical and biological characteristics	128
2. 78 MPNCW and their administrative and management features	131

List of Tables

Table 1.1. Model selection results of <i>a priori</i> models of number of aquatic bird species present in Mexican non-coastal wetlands (MNCW). Models presented include number of aquatic habitat types (Hab), altitude effects (Alt), and location effects (latitude and longitude, Lat and Long). Number of estimated parameters (k), and AIC_c weights (w_i) for each model are provided.	25
Table 1.2. Model-averaged parameter estimates for effects influencing species richness. Parameter abbreviations are as in Table 1.1	25
Table 3.1 Model selection criteria for five models explaining habitat occupancy (Ψ) by <i>C. palustris</i> during the rainy season in response to habitat type (Hab), percentage of agriculture within 10,000 m ($\%Agri$), and interactions of these two variables. AIC = Akaike information criterion, ΔAIC = scaled value of AIC , $AIC w_i$ = Akaike weights, and P_i = detectability.	101
Table 3.2. Model selection criteria for five models explaining habitat occupancy (Ψ) by <i>C. palustris</i> during the dry season in response to habitat type (Hab), percentage of agriculture within 10,000 m ($\%Agri$), and interactions of these two variables. AIC = Akaike information criterion, ΔAIC = scaled value of AIC , $AIC w_i$ = Akaike weights, and P_i = detectability.	102
Table 3.3. Model selection criteria for five models explaining habitat occupancy (Ψ) by <i>F. americana</i> during the rainy season in	104

response to habitat type (Hab), percentage of agriculture within 10,000 m (%Agri), and interactions of these two variables. AIC= Akaike information criterion, ΔAIC = scaled value of AIC, AIC w_i = Akaike weights, and P_i = detectability.

Table 3.4. Model selection criteria for five models explaining habitat occupancy (Ψ) by *F. americana* during the dry season in response to habitat type (Hab), percentage of agriculture within 10,000 m (%Agri), and interactions of these two variables. AIC= Akaike information criterion, ΔAIC = scaled value of AIC, AIC w_i = Akaike weights, and P_i = detectability. 105

Table 3.5. Model selection criteria for five models explaining habitat occupancy (Ψ) by *Ch. vociferus* during the rainy season in response to habitat type (Hab), percentage of agriculture within 10,000 m (%Agri), and interactions of these two variables. AIC= Akaike information criterion, ΔAIC = scaled value of AIC, AIC w_i = Akaike weights, and P_i = detectability. 107

Table 3.6. Model selection criteria for five models explaining habitat occupancy (Ψ) by *Ch. vociferus* during the dry season in response to habitat type (Hab), percentage of agriculture within 10,000 m (%Agri), and interactions of these two variables. AIC= Akaike information criterion, ΔAIC = scaled value of AIC, AIC w_i = Akaike weights, and P_i = detectability. 108

List of Figures

Figure 1.1. Location of 78 Protected Mexican non-coastal Wetlands. 14

Figure 1.2. A Similarity based on species present among level 1 Mexican ecoregions: WDF (Warm Dry Forests), MSE (Midland Semiarid Elevations), GP (Great Plains), MHF (Moist Hot Forests), NAD (North American Deserts), and TM (Temperate Mountains). Left panel shows results from hierarchical cluster analysis; right panel shows results of Non Metric Multidimensional Scaling analysis. Both analyses were based on fourth-root transformed species richness, and Bray-Curtis similarity. 21

Figure 1.2. B Similarity based on species present among level 2 Mexican ecoregions: SPCPR (Southern Pacific Coastal plains and ridges), SCPM (Soconusco Coastal Plains and Mountains), WCPHC (Western Coastal plain hills and canyons), SSM (Southern Sierra Madre), FSMO (Foothills Sierra Madre Occidental), ID (Intermountain depressions), TTSP (Tamaulipas-Texas Semiarid plain), MP (Mexican plateau), ESM (Eastern Sierra Madre), CASMC (Central American Sierra Madre and Chiapas Highlands), WB (Water Bodies), WSM (Western Sierra Madre), YPPM (Yucatán Peninsula Plains and Mountains), TNS (Transversal Neovolcanic System), WD (Warm deserts), and GMCPMH (Gulf of Mexico Coastal Plains and Moist Hills). Left panel shows results from hierarchical cluster analysis; right panel shows results of Non Metric Multidimensional Scaling analysis. Both analyses were based on fourth-root transformed species richness, and Bray-Curtis similarity. 22

Figure 1.3. Estimated aquatic bird species richness in MNCW as a

response to number of aquatic habitats types present. Expected number of species was estimated from model-averaged coefficients of logistic exposure models. Dotted lines indicate Standard Errors.	26
Figure 1.4. Estimated aquatic bird species richness in MNCW as a response to altitude (masl). Expected number of species was estimated from model-averaged coefficients of logistic exposure models. Dotted lines indicate Standard Errors.	26
Figure 2.1. Location of 78 Protected non-coastal Mexican wetlands.	52
Figure 2.2. Number established sites through time (black dots) and number of published management plans through time (gray triangles). Best fit poisson regression trends are shown for established sites (dotted line), and management plans (black line).	60
Figure 2.3. Number of established sites (white bars), management plans (grey bars) and conservation actions (black bars) per level 1 ecoregion. Ecoregion abbreviations are as follows: NAD=North American Deserts, MSE= Midland Semiarid Elevations, GP= Great Plains, WDF= Warm Dry Forests, MHF= Moist Hot Forests, and TM=Temperate Mountains.	62
Figure 2.4. Number of level 2 direct threats (black bars), and conservation actions (grey bars) per site.	63
Figure 2.5. Number of sites reporting different types of level 1 direct threats (black bars, capital letters), and conservation actions (grey bars, lower case letters). Threat categories are as follows: AGR=Agriculture and aquaculture, EP= Energy production and	66

mining, TRS=Transportation and service corridors, BRU= Biological resource use, HI=Human intrusions and disturbance, NSM= Natural systems modifications, IPSP=Invasive and other problematic species and genes, POLL=Pollution, and CCW=Climate change and severe weather. Conservation actions categories are as follows: lwm= Land water and management, spm= Species management, ea= Education and awareness, lpol= Law and policy, lhei=Livelihood, economic and other incentives, and ecb=External capacity building.

Figure 2.6. Number of published studies per site. 68

Figure 2.7. Number of published studies per year combining all sites, poisson regression trends are shown for the 1857-1966 (black dots, white line), and 1967-2013 (grey triangles, grey line). 69

Figure 3.1. Estimated habitat occupancy by *Cistothorus palustris* during the 2012 rainy season. 101

Figure 3.2. Estimated habitat occupancy by *Cistothorus palustris* during the 2013 dry season. 102

Figure 3.3. Estimated habitat occupancy by *Fulica americana* during the 2012 rainy season. 103

Figure 3.4. Estimated habitat occupancy by *Fulica americana* during the 2013 dry season. 104

Figure 3.5. Estimated habitat occupancy by *Charadrius vociferus* during the 2012 rainy season. 106

108

Figure 3.6. Estimated habitat occupancy by *Charadrius vociferus* during the 2013 dry season.

Resumen

"Humedales mexicanos no costeros: representatividad de aves acuáticas, ocupación del hábitat, principales amenazas, acciones de conservación y de investigación"

En total son 78 humedales no costeros protegidos (HMNCP) los cuales han sido decretados como ANP's, sitios Ramsar y/o Aicas. En la primera parte del presente estudio, se analizó la capacidad de cada uno de los 78 sitios para contribuir a la conservación de la riqueza de aves, las especies con algún grado de amenaza, y las especies con algún grado de sensibilidad. Asimismo se realizaron dos análisis para identificar la similitud en composición de especies en los niveles ecorregionales 1 y 2, y el nivel de representatividad que poseen 183 especies de aves acuáticas dentro de los 78 humedales estudiados. Se comparó la distribución potencial de cada una de las especies con respecto a toda la extensión del territorio mexicano. En general se encontró que las aves acuáticas están poco representadas dentro de estos sitios. Por último, a escala nacional se identificaron las variables que condicionan la riqueza de especies, las cuales fueron el número de tipos de hábitats acuáticos y la altitud. En la segunda parte, se determinó cuales son las amenazas directas más frecuentes sobre los 78 sitios, asimismo las acciones de conservación e investigación que se han implementado hasta el momento. Y las posibles correlaciones entre los tres rubros anteriores, encontrándose que la agricultura es la amenaza más frecuente y que existe poca correlación entre amenazas, acciones de conservación, e investigación. Y la última parte, fue un estudio de caso a dos escalas espaciales, local y de paisaje acerca del efecto de la agricultura sobre los patrones de ocupación de tres especies de aves con diferente grado de vulnerabilidad. En esta sección se concluyó que la agricultura puede tener efectos a ambas escalas, pero estos efectos dependen de la época del año.

PALABRAS CLAVE. aves acuáticas, distribución, omisiones de conservación, amenazas, acciones de conservación, investigación, ocupación de hábitat, agricultura.

Abstract

"Non-coastal Mexican wetlands: waterfowl representativeness, habitat occupancy, threats, conservation actions, and research"

In total 78 Mexican protected non-coastal wetlands (MPNCW) have been declared as NPA's, Ramsar sites and/or IBA's. In the first part, the capacity of each of the 78 sites to contribute to the conservation of bird richness, species with some degree of threat, and species with some sensitivity was analyzed. Also two analyses were performed to identify the similarity in species composition among level 1 and 2 ecoregions in terms of species composition. The level of representation that each of 183 species of waterfowl within the 78 wetlands studied was quantified, and the potential distribution of each species with respect to the full extent of Mexico was analyzed. In general, aquatic bird species are underrepresented among MPNCW. Finally, at the national scale the variables that are most important at determining species richness were identified, these were number of types of aquatic habitats and altitude. In the second part, the most common direct threats, conservation actions and research were determined for each of the 78 sites studied. Possible correlations between these three items were also investigated. It was found that agriculture is the most common threat, and that there is a lack of correlation among threats, conservation actions, and research. The last part of this study was a case study that assessed the effect of agriculture on habitat occupancy by three species of waterbirds with different degrees of vulnerability at two spatial scales; local, and landscape. The results showed that both scales are important, but the response pattern also varies among seasons of the year.

KEYWORDS. aquatic birds, distribution, conservation omissions, threats, conservation actions, research, habitat occupancy, agriculture.

Presentation and content of the Chapters

Aquatic birds are among the most charismatic components of the fauna inhabiting wetlands and are a valuable resource for research, education, and recreation. Waterbirds are also key species because they occupy important places in trophic chains and contribute to ecosystem functioning. They are also good indicators of the state of conservation and health of their ecosystems (Morrison 1986; Kushlan 1993). Regular and consistent monitoring of aquatic birds can help in the process of documenting changes both in their populations and their habitats. Monitoring of waterbird populations and communities also allows collecting information related to distribution, abundance, population trends and identification of sites that host large populations and diverse communities. Hence, populations of species in numerical regression, and the most urgent conservation actions can be identified. In addition, identifying important sites for waterbirds yields valuable information for biodiversity conservation. Species richness and abundance of species regularly using wetlands are indices that can help determine their importance.

In the first chapter of this dissertation, the conservation status of resident and migratory waterbirds distributed in 78 Mexican non-coastal wetlands (MNCW) was studied. The sites under investigation are distributed in 28 Mexican states, and have been established as Natural Protected Areas (NPA's), Wetlands of International Importance (Ramsar), and Areas of Importance for the Conservation of Birds of Mexico (IBA's). Currently, a large proportion of waterbirds associated to non-coastal wetlands are vulnerable from at least one point of view. Many of these species belong to some level of sensitivity (Stotz et al. 1996) and/or are listed in

some risk category either at the national (SEMARNAT-2010) or international level (BirdLife International 2000; CITES 2013; The IUCN Red List of Threatened Species 2013; Virkkala et al. 2013). An additional source of vulnerability is due to the loss of the natural habitats that are used by these species to develop their vital activities such as resting, roosting, feeding and/or nesting. Finally, many species are vulnerable because their distribution is highly restricted, or because their distribution ranges are not adequately represented within reserves.

In order to deepen understanding of specific threats to waterbirds inhabiting Mexican Non-coastal Wetlands, the second chapter of this dissertation was dedicated to the identification of threats, conservation actions, and research within the 78 Mexican non-coastal wetlands (MNCW) that have been established as Natural Protected Areas (NPA's), Wetlands of International Importance (Ramsar), and/or Areas of Importance for the Conservation of Birds of Mexico (IBA's). Within these sites, the loss and deterioration of native habitats of waterbirds is caused by various anthropogenic threats. In order of importance, these threats are agriculture and aquaculture, biological resource use, pollution, transportation and service corridors, human intrusions and disturbance, invasive and other problematic species and genes, natural system modifications, climate change and severe weather, and energy production and mining. Generally, in Mexico these threats have not been adequately resolved; usually the implemented management fails at responding to such threats, and thus, conservation measures required for each non-coastal wetland and its associated biota are insufficient. In addition, at the country level and within individual sites, there is no comprehensive analysis of

threats and conservation actions, and research is insufficient. Moreover, there is no relation whatsoever between threats, conservation actions, and research.

The purpose of the last chapter of this dissertation was to conduct a case study that would generate additional knowledge about the mechanisms through which agriculture and water channelization influence aquatic birds at the population level. Agriculture and channelization were selected because these impacts were identified as some of the most important throughout the country. Therefore, habitat occupancy patterns by three water bird species were investigated. The focal species were the Marsh Wren (*Cistothorus palustris*), the American Coot (*Fulica americana*), and the Killdeer (*Charadrius vociferus*). Habitat occupancy at the local scale was compared between two habitat types (aquatic vs. agriculture). At a larger, landscape scale; effects of landscape composition (proportion at landscapes of a 10-km radius) were assessed. Finally, possible interactions of local and landscape effects on habitat occupancy patterns were studied.

In the case of the Marsh Wren, the proportion of agriculture within the landscape had little effect on occupation, but this parameter was large for the water habitat, and nearly zero in agriculture independently of season. Contrastingly, habitat occupancy by the American Coot varied among seasons; during the rains, occupancy increased in both habitat types with increasing agriculture within the landscape. However, during the dry season, occupancy by this species was near zero at the agriculture, and increased exponentially with increasing agriculture within the landscape for the water habitat. And finally, for the Killdeer, in the rainy season habitat occupancy rapidly increased with increasing agriculture within the water habitat, and the opposite happened within the agricultural habitat. In

contrast, within the dry season, the agriculture was unoccupied whereas occupancy increased with increasing agriculture within the landscape for the aquatic habitat. These results illustrate how different species respond very differently in habitat occupancy to land use changes to agriculture depending on their degree of vulnerability. The mechanisms governing these responses may be related to idiosyncrasies of the species in terms of habitat needs and feeding habitats. However, many other factors associated to interactions within the community, reproductive aspects, etc. may also be involved.

References

- BirdLife International. (2000). Threatened birds of the world. Barcelona & Cambridge, UK: Lynx Edicions & BirdLife International.
- Convention on International Trade in Endangered Species of Wild Flora and Fauna (CITES). (2013). Available from: <http://www.cites.org> (accessed June 2014).
- International Union for Conservation of Nature, IUCN. (2013.2). The IUCN Red List of Threatened Species. Available from <http://www.iucnredlist.org/>.
- Kushlan, J. A. (1993). Colonial Waterbirds as Bioindicators of Environmental Change. *Colonial waterbirds*, 223-251.
- Morrison, M. L. (1986). Bird populations as indicators of environmental change; in Johnston R.J. (Ed.). *Current Ornithology*, Vol. 3:429-451. Plenum Publ. Corporation.
- Secretaría de Medio Ambiente y Recursos Naturales, SEMARNAT (2010). Norma Oficial Mexicana (NOM-059-SEMARNAT-2010), Protección ambiental-Especies Nativas de México de Flora y Fauna Silvestres-Categorías de Riesgo y Especificaciones para su Inclusión, Exclusión o Cambio-Lista de Especies en Riesgo. Diario Oficial de la Federación. 30 de diciembre de 2010, México, DF.
- Stotz D. F., Fitzpatrick J. W., Parker III T. A., & Moskovitz D. K. (1996). *Neotropical birds: ecology and conservation*. University of Chicago Press, Chicago and London.

Virkkala R., Heikkinen R. K., Fronzek S., & Leikola N. (2013). Climate Change, Northern Birds of Conservation Concern and Matching the Hotspots of Habitat Suitability with the Reserve Network. *PloS one*, 8(5), e63376.

CHAPTER 1

IDENTIFYING CONSERVATION GAPS, OMISSIONS,
AND PRIORITIES, FOR MEXICAN NON-COASTAL
WATERBIRDS

Abstract

Due to their unctiguous and restricted distribution, non-coastal wetlands are vulnerable ecological systems. Although they provide ecosystem services and maintain high levels of diversity of flora and fauna, anthropogenic disturbance threatens the viability of these ecosystems and the associated biota. This study analyzed 78 Mexican non-coastal Wetlands which receive some form of conservation management (PMNCW), including Natural Protected Areas, Wetlands of International Importance, and Areas of Importance for the Conservation of birds. To diagnose the level of protection provided to Mexican waterbirds, databases were generated and used to assess: the distribution pattern of these PMNCW, 2) the representativeness for 183 species of resident and migratory waterbirds that associate to these sites, 3) the capacity of each site to contribute to the conservation of bird richness, species at risk, and species with some level of sensitivity, and 4) the level of complementarity among the 78 PMNCW included in the study. In addition, we evaluated variables that could influence species richness at the extent of the entire country. A significant proportion of species, including some that are sensitive or in risk categories are underrepresented in the PMNCW system. We recorded less similitude among PMNCW grouped in level 1 than level 2 ecoregions. The most important environmental variables explaining species richness within sites were altitude and number of habitat types. Agencies concerned with the conservation of waterbirds should aim at identifying sites which would increase complementarity among PMNCW, and conservation should also be implemented outside protected areas.

KEY WORDS. Waterbird management, wetlands, Ramsar, NPA's, IBA's, nature reserve systems, complementarity.

Resumen

Debido a su distribución disyunta y restringida los humedales no costeros son sistemas ecológicos vulnerables. A pesar de que proveen servicios ecosistémicos y mantienen altos niveles de diversidad de flora y fauna, el disturbio antropogénico amenaza la viabilidad de estos ecosistemas y su biota asociada. Este estudio analiza 78 humedales no costeros que reciben alguna forma de manejo de conservación (HMNC), incluyendo Áreas Naturales Protegidas, Humedales de Importancia Internacional, y Áreas de Importancia para la Conservación de las aves. Para diagnosticar el nivel de protección que proveen a las aves acuáticas mexicanas, se generaron bases de datos y fueron usadas para evaluar: 1) el patrón de distribución de estos HMNC, 2) la representatividad de 183 especies de aves acuáticas residentes y migratorias que están asociadas a estos sitios, 3) la capacidad de cada sitio para contribuir en la conservación de la riqueza de especies, especies en riesgo, y especies con algún nivel de sensibilidad, y 4) el nivel de complementariedad entre los 78 HMNC incluidos en el estudio. Además, evaluamos las variables que pueden influir en la riqueza de especies en toda la extensión del país. Una significativa proporción de especies, incluyendo algunas que son sensibles o en categorías de riesgo están sub representadas en el sistema de HMNC. Se registro menor similitud entre los HMNC agrupados en el nivel ecoregional 1 que en el nivel 2. Las variables ambientales que mejor explican la riqueza de especies dentro los sitios fueron la altitud y el número de tipos de hábitats. Las agencias interesadas en la conservación de aves acuáticas deben tener como objetivo la identificación de sitios que podrían incrementar la complementariedad entre los HMNC, y la conservación también debe ser implementada afuera de las áreas protegidas.

PALABRAS CLAVE. Manejo de las aves acuáticas, humedales, Ramsar, ANP's, AICAS, sistemas de reserva natural, complementariedad.

Introduction

A large proportion of Mexican ecosystems and species face conservation risks (CONABIO 2001; SEMARNAT-2010). Mexican non-coastal wetlands (MNCW), including streams, springs, permanent or seasonal rivers, marshes, bogs, lakes, ponds, and reservoir oases, are vulnerable ecosystems because their distribution is uncontiguous and cover relatively small areas, unlike coastal ecosystems whose distribution is usually larger and contiguous. One of the various services that these ecosystems offer is the habitat that they provide to numerous species of flora and fauna. Unfortunately, alteration of their natural conditions through water extraction, pollution from urban runoff, industrial, agricultural and mining, land use changes, and urban and industrial growth has driven many of their associated species to extinction risk categories (Cooke et al. 2000; Green 2002).

Typically, non-coastal wetlands are permanently or temporarily inhabited by both people and bird communities, and have high bird abundance, richness, and diversity values (Elphick et al. 2001; Manzano-Fischer et al. 2006). However, the viability of waterbird populations is closely related to the conservation status of these ecosystems (Mistry & Simpson 2008; Faragó & Hangya 2012), which are vulnerable to anthropogenic impacts (Klein 1993; Fahrig 2003). Therefore, ecological knowledge applicable to conservation actions for these wetlands and their associated biota is necessary.

Despite their social and ecological importance, only a small percentage of Mexican wetlands are protected. Ideally, management should focus at the metapopulation level, and thus promote both genetic exchange between individual

populations (Hanski & Simberloff 1997; Margules & Pressey 2000), and their long-term viability. One of the most effective tools for natural resources conservation is the establishment of ecological reserve networks (Balmford 2002; Primack 2002). These networks should adequately represent regional ecosystems and biodiversity (Margules & Pressey 2000; Margules & Sarkar 2007). The level of representation that each species or ecosystem requires, depends on its biology (Murphy & Noon 1992), or unique ecosystem characteristics. Consequently, the appropriate level of representation varies between species and ecosystems (Scott et al. 2001; Tear et al. 2005). Therefore, the design of ecological reserve systems is a complex task.

In Mexico, different types of reserves have been established to conserve bird species which depend on MNCW. These reserve types include Natural Protected Areas (NPA's), Wetlands of International Importance (Ramsar), and Areas of Importance for the Conservation of birds (IBA's). Typically, natural reserves have been established in remote areas far from human developments. These sites are regarded as having limited quality for agriculture or livestock (Margules & Sarkar 2007). These criteria, however, may have nothing to do with the biological value and the capacity of a site to represent biodiversity (CONANP & CONABIO 2007).

Furthermore, the processes to identify reserve networks have rarely taken into account the complementarity among individual sites (Sarkar & Margules 2002; Ervin 2003; Sarkar et al. 2004). In order to identify trends within Mexico that would be useful for waterbird conservation, we hypothesized that there is a regional trend in Mexico in terms of presence of key species; arid ecosystems of Northern Mexico should be important for rallids, some waterfowl like *Chen caerulescens*, and for

some migrants such as *Grus canadensis*. Aquatic vegetation in Central Mexico should foster populations of some rallids such as *Rallus limicola*, *R. elegans*, and others such as *Coturnicops noveboracensis*. In addition, open water bodies with high water quality in this region should be feasible for diving birds as *Aechmophorus clarkii*, and *A. occidentalis*. Finally, in the south, though the Tabasco-Yucatán area is important for concentrations of some resident anatids, we didn't expected to find a pattern in this area because our analysis was based on presence and not abundance. Some areas of Yucatan region, however, should prove their importance for phalaropes, tringas, and *Phoenicopterus ruber*. In terms of species concentrations, we hypothesized that location (latitude and longitude), altitude, and number of aquatic habitat types would influence species richness so that species concentrations should be higher in: 1) southern latitudes, near coastlines and near the tropic of cancer, 2) lowlands and regions of intricate topographies, and 3) wetlands with higher number of aquatic habitat types.

Our objectives included: 1) to determine the spatial arrangement of 78 protected MNCW (thereafter PMNCW) in relation to level 1 and 2 terrestrial ecoregions for Mexico, 2) to quantify percent potential distribution relative to total area of the Mexican territory, and the level of protection and representation within 78 PMNCW for each of the 183 aquatic bird species included in the study, 3) to determine the capacity of each PMNCW to contribute to conservation of bird richness, species with some level of extinction risk, and species with some level of sensitivity, 4) to identify the degree of similarity between the PMNCW under study when these are grouped in level 1 and level 2 ecoregions, and 5) to determine how different

environmental variables (number of habitats, location, and altitude) contribute to species richness within individual PMNCW's at the country-wide extent.

The results of this study are useful for government and NGO's concerned with the establishment of conservation priorities and waterbird management implementation in Mexico. Specifically, individual waterbird species that need additional protection, and candidate regions for the establishment of new wetland reserves are identified. In addition, we identify environmental variables whose management could promote the conservation of aquatic bird species richness at the country scale. These guidelines are applicable for conservation of the entire non-coastal water-related avifauna across Mexico.

Study area

The study included 78 non-coastal Mexican wetlands that have been established as NPA's, Ramsar sites, and/or IBA's (Figure 1.1.). These sites are lacustrine (lakes, and permanent/seasonal ponds), riparian (river basins, rivers, canyons, permanent and intermittent streams, and ponds), palustrine (swamps, freshwater marshes, shrub swamps, bogs, freshwater forested wetlands, freshwater springs, and oasis), karst (sinkholes), and artificial (dams and ponds) systems.

Figure 1.1. Location of 78 Protected Mexican non-coastal wetlands.

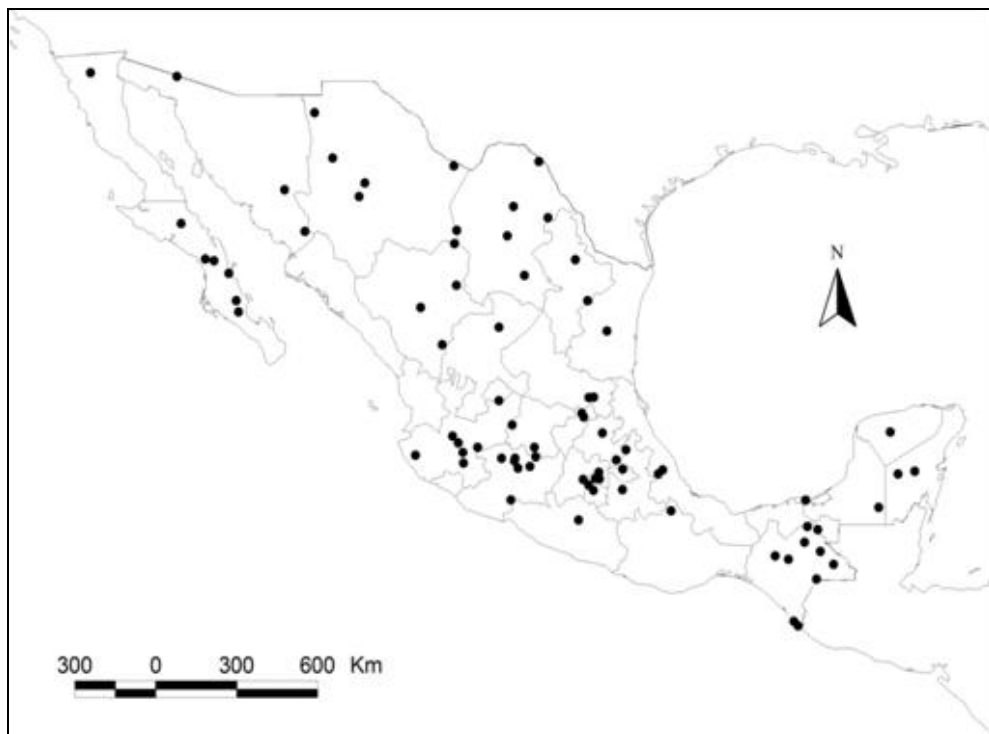

Methods

Database

We developed a database containing the list of aquatic bird species that are distributed in each of the 78 PMNCW included in this study (thereafter PMNCW). The study included 183 bird species that associate to these PMNCW during part or all of their lifecycle. This information was obtained from the Ramsar Wetlands technical sheets (The Ramsar Convention on Wetlands 2013), the IBA's of Mexico (Arizmendi & Márquez-Valdelamar 2000; CONABIO 2002), and from scientific publications (Arriaga-Cabrera et al. 1997; Rojas-Soto et al. 1999; 2002; Garza et al. 2007; Palomera et al. 2007; Pineda et al. 2010; Valencia-Herverth et al. 2011). For sites lacking species lists, or whose published listings are clearly incomplete, we consulted published potential distribution models for Mexican bird species (Navarro-Sigüenza & Peterson 2007), and based on this information we determined if the species is likely to be present or absent from the site.

Conservation potential of individual sites

For each species, we entered additional information related to various vulnerability categories according to the following criteria; criterion 1) the Mexican list of species at risk (SEMARNAT-2010) with values 1=subject to special protection, 2=threatened, and 3=endangered, criterion 2) sensitivity level according to Stotz et al. (1996) with values 1=low, 2=medium, and 3=high, criterion 3) CITES (Convention on International Trade in Endangered Species of Wild Fauna and Flora, 2012) with values 1=species for which Mexico has requested assistance from other members, and 2=species for which trade must be controlled, criterion 4)

IUCN (International Union for Conservation of Nature 2013) with values 1=least concern, 2=near threatened, 3=vulnerable, and 4=endangered. Finally, the database was reviewed by Mexican aquatic bird experts (R. Pineda-López and J.P. Tenorio) and the suggested changes from these experts were incorporated in the database.

The conservation potential index for each site was calculated from the following information: 1) total number of species, 2) NOM value, the sum of values for the level of vulnerability associated to all species present in each site, 3) sensitivity value, the sum of sensitivity values according to Stotz et al. (1996) across all species present in each site, 4) CITES value, the sum of all values from the CITES appendices associated to each species present in each site, and 5) IUCN value, the sum of the values corresponding to threat categories from the IUCN Red List for each species present in each site. To calculate the conservation potential index we homogenized the scale across all five criteria as follows: we calculated the maximum possible value for each criteria taking into account the total number of species considered in the study, and standardized the scale for each site by calculating the percentage of each criterion corresponding to each site with respect to 100%, which is the maximum possible value if all 183 species were present. Then, we calculated the index with the following formula: $CPI = (R \times 0.20) + (NOM \times 0.20) + (S \times 0.20) + (CITES \times 0.20) + (IUCN \times 0.20)$, where R=standardized total number of species for a given site, NOM=standardized NOM value, S=standardized sensitivity value, CITES=standardized CITES value, and IUCN=standardized IUCN value. This index takes values from zero to 100 where

zero corresponds to a site with no value for conservation of waterbirds, and 100 corresponds to a site with the highest possible conservation value.

Similarity among ecoregions

Based on species composition, we evaluated similarity among level 1, and among level 2 ecoregions (INEGI et al. 2008). For this purpose we performed Non Metric Multidimensional Scaling Analysis (NMMDS, Clarke 1993) based on Bray-Curtis similarity of fourth-root transformed richness of each site, to identify groups of ecoregions having similar assemblages in terms of species composition. For this analysis we included additional data in our database indicating level 1 and level 2 ecoregion in which each PMNCW is embedded. Using the same database, we conducted hierarchical cluster analysis based on Bray-Curtis similarity to classify ecoregions based on their similarity in terms of species composition. Both NMMS and hierarchical cluster analysis were conducted using Program Primer (Clarke & Gorley 2006), and the results of both analyses were displayed in adjacent figures for ease of interpretation.

Spatial arrangement of PMNCW

Using Arc View 3.3 (Environmental Systems Research Institute 2002) we overlapped layers of level 1 and level 2 terrestrial ecoregions of Mexico (INEGI et al. 2008) with a layer depicting locations of each PMNCW. We then determined which ecoregions do not contain or contain a few limited number of PMNCW.

Potential distribution and protection level

For all 183 species considered in the study, we download models of potential niche distribution from the National Commission for the Knowledge and Use of Mexican Biodiversity (CONABIO; Navarro-Sigüenza & Peterson 2007). These are the best available maps of Mexican species potential distributions. Using these models, we quantified proportion of the Mexican territory potentially occupied by each species. Then, we assigned each species to one of the following distribution categories: 1) highly restricted potential distribution, corresponding to species present in $\leq 3\%$ of the Mexican territory, 2) restricted potential distribution species that are present in $>3\%$ and $<10\%$ of the territory, 3) wide potential distribution, corresponding to species present in $>10\%$ and $< 25\%$ of the country, and 4) very wide potential distribution, corresponding to species that occupy $\geq 25\%$ of the Mexican territory.

For each species, based on total potential distribution area from ecological niche models (see above), we quantified proportion of species potential distribution included within PMNCW. Based on the criteria defined by the International Convention on Biological Diversity (United Nations, Convention on Biological Diversity 2004) we assigned each species to one of the following protection level categories: 1) adequately represented, corresponding to species that are present in at least 18% of all sites, 2) type I conservation omissions, corresponding to species that are present in $>13\%$ and $<18\%$ of all sites, 3) type II conservation omissions, corresponding to species present in $<13\%$ of the sites, and 4) conservation gaps, corresponding to species that are absent from all sites. For

species having potential distribution ranges which vary among seasons, we only considered the most restricted and/or least protected distribution for the final analyses.

Number of aquatic bird species

We used generalized lineal models to assess the effect of site location, altitude, and number of aquatic habitat types present on richness of aquatic birds. Akaike's Information Criterion corrected for small sample sizes (*AICc*), and Akaike weights (*w_i*) were used to evaluate support for several *a priori* models of our hypotheses related to effects influencing number of aquatic bird species (Burnham & Anderson 2002). We constructed the following eight models: 1) a null model which only included an intercept term, 2) linear effects of number of aquatic habitat types, 3) linear effects of site location which included latitude and longitude, expressed in decimal degrees, 4) linear effects of altitude, 5), 6), and 7) linear two-way combinations of all of the above models, and 8) a global model incorporating all effects from previous models. We used *AICc*, ΔAIC , and *w_i* to rank models from most to least supported by the data (Burnham & Anderson 2002). Then, to account for model-selection uncertainty, we calculated model-averaged weighted parameter estimates and their associated standard errors using *w_i* as weights as suggested by Burnham & Anderson (2002). All generalized lineal models, as well as model ranking and calculations of model-averaged parameter estimates were performed using the R statistical package (R Development Core Team 2010), and the libraries *MASS*, *bbmle*, and *AICcmodavg*.

Results

Conservation potential of individual sites

The conservation potential index ranged from 8.46 to 53.10, and averaged 29.51. The three sites with the highest values were: Cajón de Peñas Dam with a value of 53.10, Hanson Lagoon, 1857 Constitution National Park with a value of 51.63, and Yaqui River Basin valued in 50.87. The three sites with the lowest values were: System of Dams and Biological Corridors of Necaxa River Basin with a value of 9.74, Atlagantepec Dam with a value of 9.29, and Jaco Lagoon valued in 8.46. Number of aquatic bird species per site ranged from 21 to 126 and averaged 69.6. There are 46 species listed in the NOM-059 (SEMARNAT-2010), 15 within CITES, and 23 are classified in the higher level of Sensitivity according to Stotz et al. (1996).

The pattern of key species present varies throughout the country; in the north many migrant, some rallids, and waterfowl are present. Central Mexico is distinguished for the presence of species with restricted distributions such as *Rallus limicola*, *R. elegans*, and *C. noveboracensis*. Finally at the south, the Yucatan region is very important for some phalaropes, tringas, and also for *Phoenicopterus ruber*.

Similarity among ecoregions

Considering level 1 ecoregions, and based on both NMMS and hierarchical cluster analysis, there was clear separation between ecoregions; we identified four distinctive groups, two of which contain two ecoregions and two containing one

ecoregion (Figure 1.2. A). On the other hand, when the analysis was based on level 2 ecoregions, the presence of five groups of ecoregions could be identified. In this case, however, the separation within and among these five groups was subtle (Figure 1.2. B).

Figure 1.2. A. Similarity based on species present among level 1 Mexican ecoregions: WDF (Warm Dry Forests), MSE (Midland Semiarid Elevations), GP (Great Plains), MHF (Moist Hot Forests), NAD (North American Deserts), and TM (Temperate Mountains). Left panel shows results from hierarchical cluster analysis; right panel shows results of Non Metric Multidimensional Scaling analysis. Both analyses were based on fourth-root transformed species richness, and Bray-Curtis similarity.

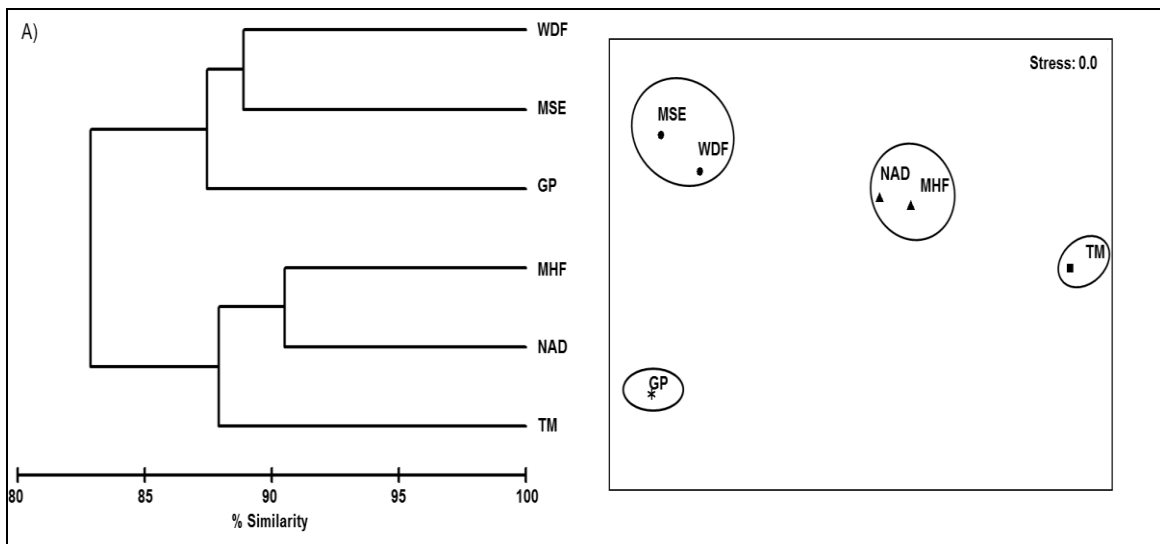
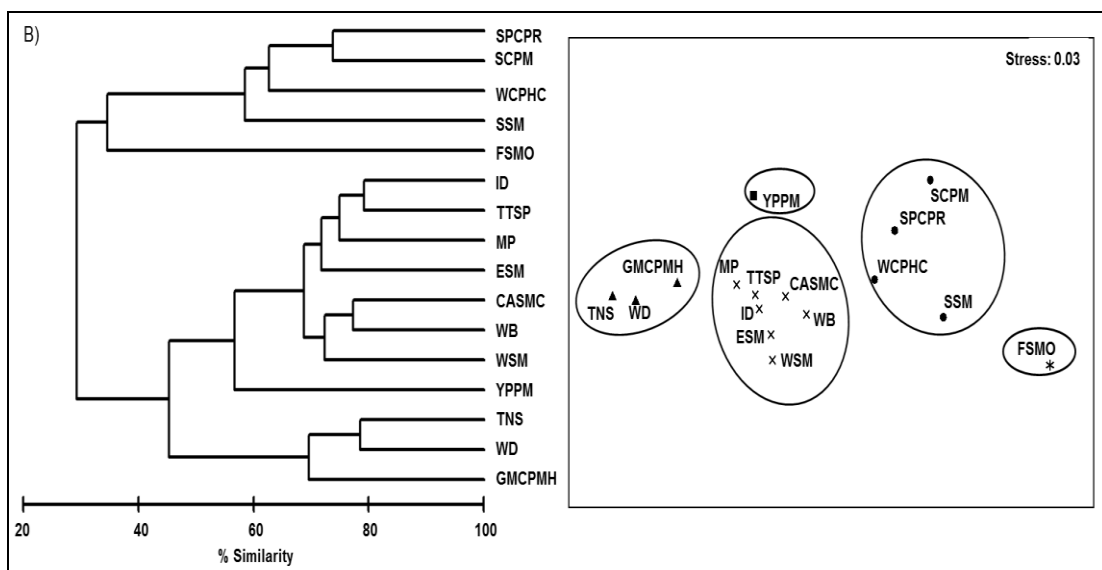

Figure 1.2. B. Similarity based on species present among level 2 Mexican ecoregions: SPCPR (Southern Pacific Coastal plains and ridges), SCPM (Soconusco Coastal Plains and Mountains), WCPHC (Western Coastal plain hills and canyons), SSM (Southern Sierra Madre), FSMO (Foothills Sierra Madre Occidental), ID (Intermountain depressions), TTSP (Tamaulipas-Texas Semiarid plain), MP (Mexican plateau), ESM (Eastern Sierra Madre), CASMC (Central American Sierra Madre and Chiapas Highlands), WB (Water Bodies), WSM (Western Sierra Madre), YPPM (Yucatán Peninsula Plains and Mountains), TNS (Transversal Neovolcanic System), WD (Warm deserts), and GMCPMH (Gulf of Mexico Coastal Plains and Moist Hills). Left panel shows results from hierarchical cluster analysis; right panel shows results of Non Metric Multidimensional Scaling analysis. Both analyses were based on fourth-root transformed species richness, and Bray-Curtis similarity.



Spatial arrangement of PMNCW

From all seven level 1 Mexican ecoregions, only one, the Mediterranean Californian ecoregion, did not contain any PMNCW, and another ecoregion contained only three PMNCW. On the other hand, only 16 out of 23 level 2 ecoregions contain PMNCW. Level 2 ecoregions not containing any PMNCW are Mediterranean californian, Northwest lowlands of the Yucatan Peninsula, Coastal plain of Texas-Louisiana, Gulf of Mexico Coastal Plains and Dry Hills, Western plains and ridges, Tuxtla Sierra, and Sierra and Cape plains. In addition, three level 2 ecoregions had one PMNCW each, five ecoregions had two PMNCW each, and three ecoregions had three PMNCW each.

Potential distribution and protection level

Of the 183 species considered, 10.4% (n=19) have highly restricted potential distribution, 16.9% (n=31) have restricted potential distribution, 34.4 % (n=63) have wide potential distribution, and 38.3% (n=70) are potentially very widely distributed. On the other hand 4.4% of all 183 species (n=8) have an adequate representation, 2.2% (n=4) correspond to type I conservation omissions, 92.9% (n=170) are type II conservation omissions, and 0.54% (n=1, *Coturnicops noveboracensis*) is a conservation gap.

Ten species simultaneously have a very limited protection, and restricted distribution. These are: *Podiceps auritus*, *Branta bernicla*, *Coturnicops noveboracensis*, *Rallus longirostris*, *Grus americana*, *Charadrius melodus*, *Aphriza virgata*, *Setophaga petechia*, *Geothlypis beldingi*, and *G. flavovelata*.

Number of aquatic bird species

The model explaining species richness which received the most support from the data included linear effects of altitude as the only explanatory variable. In addition, the model including number of habitat types and altitude, received support equivalent to the best-supported model ($\Delta AIC_c=1.5$). No additional models received substantial support from the data ($\Delta AIC_c < 2$, Table 1.1.). Based on model-averaged parameter estimates (Table 1.2.), we concluded that expected number of species slightly increased with increasing number of habitat types (Figure 1.3.), and decreased with increasing altitude (Figure 1.4.). Data dispersion, however, was large, especially for effects of number of habitat types, suggesting that model fit was moderate (Figures 1.3. and 1.4.). No additional variables had substantial effects on number of species present.

Table 1.1. Model selection results of *a priori* models of number of aquatic bird species present in Mexican non-coastal wetlands (MNCW). Models presented include number of aquatic habitat types (Hab), altitude effects (Alt), and location effects (latitude and longitude, Lat and Long). Number of estimated parameters (k), and AIC_c weights (w_i) for each model are provided.

Model	k	AIC_c	ΔAIC_c	w_i
Alt	3	722.1	0.0	0.56437
Hab+Alt	4	723.6	1.5	0.26762
Alt+Lat+Long	5	726.3	4.1	0.07201
Null	2	727.3	5.2	0.04183
Global	6	728.0	5.8	0.03066
Hab	3	729.2	7.0	0.01668
Lat+Long	4	731.6	9.5	0.00492
Hab+Alt+Long	5	733.5	11.4	0.00191

Table 1.2. Model-averaged parameter estimates for effects influencing species richness. Parameter abbreviations are as in Table 1.1.

Effect	Coefficient	SE
Intercept	75.44	21.3
Hab	2.16	2.65
Alt	-0.01	0
Lat	-0.47	1.08
Long	-0.38	0.74

Figure 1.3. Estimated aquatic bird species richness in MNCW as a response to number of aquatic habitats types present. Expected number of species was estimated from model-averaged coefficients of logistic exposure models. Dotted lines indicate Standard Errors.

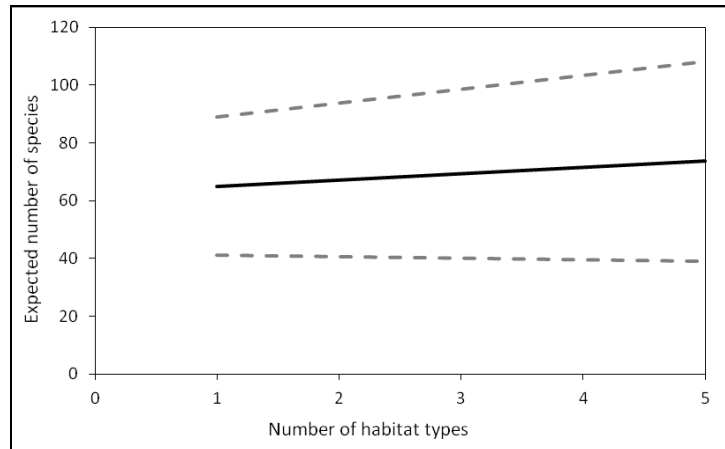
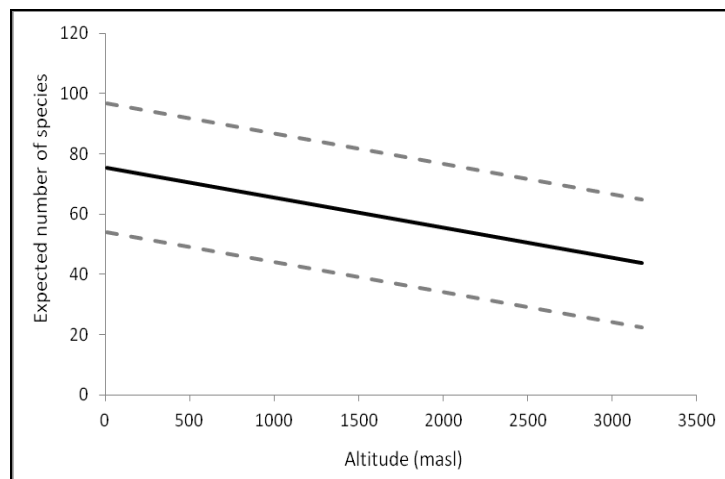

Figure 1.4. Estimated aquatic bird species richness in MNCW as a response to altitude (masl). Expected number of species was estimated from model-averaged coefficients of logistic exposure models. Dotted lines indicate Standard Errors.



Discussion

The efficiency of conservation networks should be systematically assessed, taking into account the effectiveness of the design and management, as well as ecological integrity (Ervin 2003). The effectiveness of the design is related to the location, number (Godet et al. 2007), shape, size, and composition of sites (Kunin 1997; Donnelly & Marzluff 2004). These features promote reserve networks containing richness and abundance of flora and fauna that are as representative as possible of the biodiversity of the ecosystems to be protected (Church et al. 2000), which in turn is an indication of environmental integrity. Our results allowed us to make inferences related to the effectiveness of the PMNCW system in terms of ecological integrity. Specifically, we evaluated, 1) the effectiveness of the design, 2) the protection level provided to waterbird community, and 3) the level of protection provided to individual species. These results show that the distribution pattern of PMNCW is not uniform among ecoregions, which may reflect a lack of conservation strategy implementation in various ecoregions of the country. The pattern that we documented can clearly be used as a basis for conservation planning at the ecoregional level. Both government and NGO's should probably set the priority of identifying and establishing of PMNCW in ecoregions that are poorly or not represented by PMNCW. We also found that whereas most waterbird species are present in at least one PMNCW, potential distribution of most species, including some that are vulnerable, is not adequately represented according to international standards (United Nations, Convention on Biological Diversity 2004).

The scaling approach of landscape ecology, allowed us to identify a pattern of similarity among ecoregions; when the grain used was coarse, only moderate similarity was found among level 1 ecoregions in terms of species composition. Using a finer grain, on the other hand, revealed that level 2 ecoregions were more similar among them. Finer resolution also revealed that a large proportion of the ecoregions were unrepresented. This result is consistent with previous studies suggesting that management should be implemented at fine scales, but coordinated at larger scales (e.g., Chapa-Vargas & Monzalvo-Santos 2012).

The lack of homogeneous distribution of PMNCW is in consistency with results reported by similar studies which analysed the distribution of Mexican protected areas, and the representation within protected areas of different taxa across ecoregions (e.g., Pérez-Arteaga et al. 2002; Pérez-Arteaga & Gaston 2004). Previous studies have also confirmed the limited effectiveness and representativeness of biodiversity by Mexican NPA's (Brandon et al. 2005; Castaño-Villa 2005).

This pattern has originated from a lack of correlation between reserve location and biodiversity of different taxa, which also reflects limitations in the planning process. Regarding non-coastal wetlands in Mexico, the information related to the species present is fragmented, because inventories and monitoring processes have been limited (Kushlan et al. 2002). As a consequence of both, this lack of information, and the limitations of the protected areas system, a large proportion of Mexican biodiversity remains unprotected or is poorly represented in the current system of NPA's. In consistency with this information, our results indicate that potential distribution of most non-coastal aquatic bird species is inadequately protected.

Moreover, nearly one third of all species have very restricted potential distribution within the country, whereas the remaining species have wide or very wide potential distribution. The species *P. auritus* and *A. virgata* are of special concern because they have both restricted potential distribution and poor representation within PMNCW. Moreover, these species are not listed in the Mexican list of species at risk. Therefore, we suggest that further studies related to their population status are necessary. Overall, our results indicate that it is necessary to identify and establish new wetland sites harbouring some of the species that we identified as being poorly protected.

The number of species present varied substantially among individual PMNCW, and consequently, conservation potential also varied substantially. This difference is potentially influenced by several factors such as wetland size, climatic conditions, diversity of habitats present, latitudinal location, etc. In addition, we used data from different sources that may have different degrees of quality and accuracy. Consequently some of these differences could be related to data quality. Therefore, our results are valid only at the coarse scale of our study. At the countrywide scale, we identified number of habitats present and altitude as variables influencing number of species present. Latitude and longitude were not important at this scale, maybe because these variables are important at coarser scales (Turner et al. 2001). On the other hand, many variables including biotic interactions, food availability, wetland area, disturbance and succession, hydrologic regime, salinity, water fluctuation, depth, and connectivity among wetlands may be important determinants of species at the smaller, within site scale (Marques & Vicente 1999; Fletcher & Koford 2004; Jaksic 2004; Paracuellos & Tellería 2004;

González-Gajardo et al. 2009; Ma et al. 2010; Sonal et al. 2010; Peña-Villalobos et al. 2012), and these variables could not be quantified at the scale of our study. Thus, the large variation in all these factors caused the range in conservation value for PMNCW, and this variation should be considered for conservation planning purposes.

Regarding individual species, our results agree with those from previous studies (e.g., Pérez-Arteaga & Gaston 2004), which have shown that although some Mexican species are well represented by conservation efforts (e.g., *Dendrocygna autmnalis*, *Anas clypteata*, *A. discors*, *A. cyanoptera*, *A. americana*, *Aythya valisineria*, and *Oxyura jamaicensis*), many others receive inadequate protection (e.g., *Cairina moschata*, *Falco femoralis*, *F. peregrinus*, *Geothlypis beldingi*, *G. flavovelata*, *G. speciosa*, *Ixobrychus exilis*, *Plegadis chihi*, *Agamia agami*, *Pandion halietus*, *Bucephala albeola*, *Buteogallus urubitinga*, and *Rallus elegans*). Again, these results confirm that the natural reserves are insufficient to protect biodiversity across the country. Consequently, we conclude that there are limitations to conservation actions for species of different taxonomic groups. The NPA's, for example, exclude the distribution of representatives of some groups such as mammals (Ceballos 2007; Vázquez & Valenzuela-Galván 2009) and some waterfowl whose populations are in decline such as *Anas strepera*, *A. platyrhynchos*, *A. crecca*, *A. americana*, *A. acuta*, *Aythya affinis*, *A. collaris*, *Branta canadensis*, *Cairina moschata*, and *Dendrocygna bicolor* (Pérez-Arteaga et al. 2002; Pérez-Arteaga & Gaston 2004). This is in part, because areas that have been intensely studied have often been protected, whereas those remaining largely unknown are devoid of conservation strategies. Furthermore, there has been a

tendency to protect remote, inaccessible sites (Peres & Terborg 1995; Margules & Pressey 2000).

Therefore, it is essential to develop scientific studies to determine which new areas merit inclusion within the conservation priorities. In addition, considering the political difficulties related to protected area implementation in Mexico, and that in reality, management for conservation in Mexico is not always implemented within these reserves, conservation strategies should also consider areas outside NPA's. An ideal approach of quality matrix in terms of ecological landscape and agroecological management of ecosystems will be one that simultaneously seeks to conserve wildlife habitat and encourage human food production. Alternatives for this type of management should consider habitat management to promote habitat quality at the local scale, and habitat diversity within the agricultural matrix at the landscape scale.

The group of endangered species has not been comprehensively evaluated. Therefore, the level of protection for some of these species such as *Cairina moschata*, *Cygnus columbianus*, *Nomonyx dominicus*, *Nyctanassa violaceus*, and *Jabiru mycteria* (SEMARNAT-2010) is not known in detail. Among these are some of the species most susceptible to local extinction due their specialized habitat requirements, restricted distribution, and susceptibility to anthropogenic disturbances such as habitat loss, degradation, and fragmentation (Lawler et al. 2003). This group should be considered among the top conservation priorities.

In terms of planning for the conservation of non-coastal water birds, it is also important to note that the published models of potential distribution of these species (Navarro-Sigüenza & Peterson 2007) seem to overestimate actual

distribution areas; these models suggest that the distribution of these species correspond to large polygons. However, the location of these species is more restricted because within these large polygons, they only occupy MNCW. Although it is likely that conservation omissions analyses (see Koleff et al. 2009 for details) underestimate their level of protection, these birds are more vulnerable than terrestrial species due to their uncontiguous distribution. This distributional pattern, in combination with the level of threat to these species, habitat specificity, population rarity, as well as rarity and fragility of their habitat, are indicators of vulnerability or threat to aquatic species in terms of metapopulation dynamics. Therefore, it is very likely that many Mexican non-coastal waterbirds require a higher protection level in comparison with other species. They probably require a protection level which surpasses the usual 18% of their current distribution (Scott et al. 2001; Tear et al. 2005).

To achieve the conservation of Mexican biological diversity, it is fundamental to establish networks of sites with high richness of aquatic avifauna. In addition, it is important to provide some redundancy between sites in terms of shared species. This could promote genetic exchange between populations, and thus facilitate the existence of genetic diversity at the metapopulation level (Pulliam 1988; Goldstein & Holsinger 1992; Pickett & Meeks-Wagner 1995). Choosing complementary priority areas ensures long-term persistence of communities (Navarro-Sigüenza et al. 2011). Perhaps, management for complementarity among reserves should be planned at both coarse and intermediate scales; in this study we corroborated our hypothesized patterns in terms of importance of wetlands of Northern, Central, and Southern Mexico for key species, suggesting that this may be the scale in which

management for metapopulations may function. On the other hand, patterns of species richness suggested that similarity at the community level vary to some degree at coarser scales. According to our results, most of the 78 MNCW evaluated showed intermediate values of similarity in terms of species composition. These results agree with those obtained by similar studies which analyzed land and coastal birds, or other animal groups within specific regions of Mexico (Ramírez-Albores 2007; Bojorges-Baños 2011). High similarity values suggest that sites could provide an adequate level of redundancy for shared species. This redundancy, however, could mean a sacrifice in terms of complementarity among sites. Therefore, a balance between similarity and complementarity should be accomplished at the regional scale. The intermediate levels of similarity that we recorded may indicate that this balance is accomplished.

However, it remains to be seen whether the dispersal ability of individual species, allows them to maintain a good level of genetic exchange between sub-populations to ensure metapopulation genetic viability at the long-term. Additionally, the results suggest that future conservation efforts should contemplate increasing redundancy for species which occurred in a limited number of PMNCW (e.g., *Podiceps auritus*, *Cygnus columbianus*, *Laterallus jamaicensis*, *Charadrius melodus*, *Limosa haemastica*, etc.), and especially for species that are absent from the PMNCW such as *Coturnicops noveboracensis* and *Anous stolidus*. In order to establish conservation strategies for these species, it is first necessary to identify whether the source of rarity is related to their restricted distribution, low local abundance (Méndez-Iglesias 1998), nature (eg., *Anous stolidus*) or anthropogenic disturbances. In any event, because their potential distribution is

underrepresented, establishing research programs and conservation strategies for their protection should be a priority. Specifically, additional priority sites should be those harbouring species that are currently underrepresented in the current PMNCW network (Ceballos 2007). Regarding species that are misrepresented or those having some degree of vulnerability, studies aimed at clarifying factors affecting their population viability such as population size, metapopulation genetics (Koopman et al. 2007) and habitat protection would certainly contribute to their conservation.

Additionally, it is necessary to identify sites whose protection will promote conservation of waterbirds at both the population and community levels under different climate change scenarios. It is also necessary to establish conservation priorities that consider individual species listed as threatened, rare, endemic, and those that are valuable for humans. Also, biological communities that are threatened or those which hold high diversity values should be taken into account among conservation plans (Primack et al. 2001).

References

- Arizmendi, M.C., & Márquez-Valdelamar L. (Eds). (2000). Áreas de Importancia para la Conservación de las Aves en México. México: CONABIO & CIPAMEX.
- Arriaga-Cabrera, L., Díaz, S., Domínguez, R., & León, J. L. (1997). Composición florística y vegetación. In L. Arriaga, & R. Rodríguez Estrella (Eds.), *Los oasis de la península de Baja California* (pp. 69-106). La Paz Baja California Sur, México: SIMAC & CIBNOR.
- Balmford, A. (2002). Selecting sites for conservation. In K. Norris, & D.J. Pain (Eds.), *Conserving Bird Biodiversity, General Principles and their Applications* (pp.74-104). Cambridge, UK: Cambridge University Press.
- Bojorges-Baños, J.C. (2011). Riqueza y diversidad de especies de aves asociadas a manglar en tres sistemas lagunares en la región costera de Oaxaca, México. *Revista Mexicana de Biodiversidad*, 82, 205-215.
- Brandon, K., Gorenflo, L.J., Rodrigues, A.S.L., & Waller, R.W. (2005). Reconciling Biodiversity Conservation, People, Protected Areas and Agricultural Suitability in Mexico. *World Development*, 33,1403-1418.
- Burnham, K.P., & Anderson, D.R. (2002). Multimodal inference: understanding AIC and BIC in model selection. *Socio. Meth. Res*, 33, 261-304.
- Castaño-Villa G.J. (2005). Áreas protegidas, criterios para su selección y problemáticas en su conservación. *Boletín Científico, Centro de Museos, Museo de Historia Natural*, 10, 79-101.

- Ceballos G. (2007). Conservation priorities for mammals in megadiverse Mexico: the efficiency of reserve networks. *Ecological Applications*, 17, 569-578.
- Chao, A., Chazdon, R.L., Colwell, R.K., & Shen, T. (2005). A new statistical approach for assessing similarity of species composition with incidence and abundance data. *Ecology Letters*, 8, 148-159.
- Chapa-Vargas, L., & Monzalvo-Santos K. (2012). Natural protected areas of San Luis Potosí, Mexico: ecological representativeness, risks, and conservation implications across scales. *International Journal of Geographical Information Science*, 26, 1625-1641.
- Church, R., Gerrard, R., Hollander, A., & Stom, D. (2000). Understanding the tradeoffs between site quality and species presence in reserve site selection. *Forest Science*, 46, 157-167.
- Clarke, K.R. (1993). Non-parametric multivariate analyses of changes in community structure. *Australian Journal of Ecology*, 18(1), 117-143.
- Clarke, K.R., & Gorley, R.N. (2006). Primer v6: User manual/Tutorial. Primer-E. Plymouth.
- Collwell R.K. (2009). EstimateS, Statistical Estimation of Species Richness and Shared Species from Samples, version 8.2.0, copyright Colwell RK. Available from: <http://viceroy.eeb.uconn.edu/estimates> (accessed April 2012).
- Comisión Nacional para el Conocimiento y Uso de la Biodiversidad. (2001). In CONABIO (Ed.), Provincias biogeográficas de México, Escala 1:4 000000. México DF: CONABIO.

Comisión Nacional para el Conocimiento y Uso de la Biodiversidad. (2002). In CONABIO (Ed.), Acceso a la información de cada AICA por lista. Available from: <http://conabioweb.conabio.gob.mx/aicas/doctos/aicaslista.html> (accessed August 2012).

Comisión Nacional de Áreas Naturales Protegidas, Comisión Nacional para el Conocimiento y Uso de la Biodiversidad. (2007). Mapa de AP para los análisis de vacíos y omisiones en conservación. México DF: CONANP, CONABIO (Eds.).

Convention on International Trade in Endangered Species of Wild Flora and Fauna (CITES). (2012). Available from: <http://www.cites.org> (accessed September 2012).

Cooke, F., Francis, C.M., Cooch, E.G. & et al. (2000). Impact of hunting on population growth of midcontinent lesser snow geese. In H. Boyd (Ed.), *Population modeling and management of snow geese* (pp. 17–31). Ontario Canada: Canadian Wildlife Service, Occasional Paper 102.

Donnelly, R., & Marzluff, J.M. (2004). Importance of reserve size and landscape context to urban bird conservation. *Conservation Biology*, 18, 733-745.

Elphick, C.S., Dunning, J.B., & Sibley, D.S. (2001). *The Sibley Guide to Bird Life and Behaviour*. New York: Knopf.

Environmental Systems Research Institute (ESRI). (2002). ArcView v. 3.3., Redlands, California: Environmental Systems Research Institute.

Ervin, J. (2003). Protected Area Assessments in Perspective. *Bioscience*, 53(9), 819-822.

- Fahrig, L. (2003). Effects of Habitat Fragmentation on Biodiversity. *Annual Review of Ecology, Evolution, and Systematics*, 34, 487-515.
- Faragó, S., & Hangya, K. (2012). Effects of water level on water bird abundance and diversity along the middle section of Danube River. *Hydrobiologia*, 697(1), 15-21.
- Fletcher, R.J., & Koford, R.R. (2004). Consequences of rainfall variation for breeding wetland blackbirds. *Canadian Journal of Zoology*, 82, 1316–1325.
- Garza, A., Aragón, E.E., Neri, M., Sánchez, A., De León, G.D., & Gutiérrez, S.R. (2007). Guía de aves de la Reserva de la Biósfera de Mapimí. Durango, Durango: Instituto de Ecología A.C.
- Godet, L., Devictor, V., & Jiguet, F. (2007). Estimating relative population size included within protected areas. *Biodiversity Conservation*, 16(9), 2587-2598.
- Goldstein, D.B., & Holsinger, K.E. (1992). Maintenance of Polygenic Variation in Spatially Structured Populations: Roles for Local Mating and Genetic Redundancy. *Evolution*, 46(2), 412-429.
- González-Gajardo, A., Victoriano, P., & Schlatter, P. (2009). Waterbird Assemblages and Habitat Characteristics in Wetlands: Influence of Temporal Variability on Species-Habitat Relationships. *Waterbirds*, 32(2), 225-233.
- Green, A.J. (2002). Analyses of Globally Threatened Anatidae in Relation to Threats, Distribution, Migration Patterns, and Habitat Use. *Conservation Biology*, 10(5), 1435-1445.

- Hanski, I., & Simberloff, D. (1997). The metapopulation approach, its history, conceptual domain, and application to conservation. In I.A. Hanski, & M.E. Gilpin (Eds.), *Metapopulation Biology* (pp. 5-26). San Diego, California Academic Press.
- Instituto Nacional de Estadística, Geografía e Informática (INEGI), Comisión Nacional para el Conocimiento y Uso de la Biodiversidad (CONABIO), Instituto Nacional de Ecología (INE) (2008). Available from: <http://www.conabio.gob.mx/informacion/gis/> (accessed November 2013).
- International Union for Conservation of Nature, IUCN (2013.2). The IUCN Red List of Threatened Species. Available from: <http://www.iucnredlist.org/> (accessed July 2012).
- Jaksic, F.M. (2004). El niño effects on avian ecology: lessons learned from the southeastern pacific. *Ornitología Neotropical*, 15 (Suppl.), 61–72.
- Klein, M.L. (1993). Waterbird behavioral responses to human disturbances. *Wildlife Society Bulletin*, 21, 31-39.
- Koleff, P., Tambutti, M., March, I.J., Esquivel, R., Cantú, C., & Lira-Noriega, A. (2009). Identificación de prioridades y análisis de vacíos y omisiones en la conservación de la biodiversidad de México. In Capital natural de México, vol II: *Estado de conservación y tendencias de cambio* (pp. 651-718). México, CONABIO.
- Koopman, M.E., Hayward, G. D., & McDonald, D. B. (2007). High connectivity and minimal genetic structure among North American Boreal Owl (*Aegolius funereus*) populations, regardless of habitat matrix. *The Auk*, 124(2), 690-704.

- Kunin, W. E. (1997). Sample shape, spatial scale and species counts: Implications for reserve design. *Biological Conservation*, 82(3),369-377.
- Kushlan, J. A., Steinkamp, M., Parsons, K. et al. (2002). Waterbird conservation for the Americas: The North American waterbird conservation plan, version 1. Waterbird Conservation for the Americas: Washington, D.C.
- Lawler, J. J., White, D., Sifneos, J. C. & Master, L. (2003). Rare Species and the Use of Indicator Groups for Conservation Planning. *Conservation Biology*, 17(3), 875-882.
- Ma, Z., Cai, Y., Li, B., & Chen, J. (2010). Managing Wetland Habitats for Waterbirds: An International Perspective. *Wetlands*, 30,15–27.
- Manzano-Fischer, P., List, R., Ceballos, G., & Cartron, J. E. (2006). Avian diversity in a priority area for conservation in North America: the Janos-Casas Grandes Prairie Dog Complex and adjacent habitats in northwestern Mexico. *Biodiversity and Conservation*, 15(12), 3801-3825.
- Margules, C. R., & Pressey, R. L. (2000). Systematic conservation planning. *Nature*, 405, 243–253.
- Margules, C. R., & Sarkar, S. (2007). Systematic Conservation Planning. Cambridge, Cambridge: University Press.
- Marques, P., & Vicente, L. (1999). Seasonal variation of waterbird prey abundance in the sado estuary rice fields. *Ardeola*, 46(2), 231-234.
- Méndez-Iglesias, M. (1998). Aves comunes y raras: patrones, causas y consecuencias. *El Draque*, 3, 187-200.

- Mistry, J., Berardi, A., & Simpson, M. (2008). Birds as indicators of wetland status and change in the North Rupununi, Guyana. *Biodiversity and Conservation*, 17(10), 2383-2409.
- Murphy, D. D., & Noon, B. R. (1992). Integrating Scientific Methods with Habitat Conservation Planning: Reserve Design for Northern Spotted Owls. *Ecological Applications*, 2(1), 3-17.
- Navarro-Sigüenza A.G., & Peterson, A.T. (2007). Catálogo de metadatos geográficos. CONABIO. Available from: <http://www.conabio.gob.mx/informacion/metadatos/gis/> (accessed December 2012).
- Navarro-Sigüenza, A. G., Lira-Noriega, A., Arizmendi, M. C., Berlanga, H., Koleff, P., García-Moreno, J., & Townsend, A. (2011). *Áreas de conservación para las aves: hacia la integración de criterios de priorización* (pp. 109-129). In P. Koleff, & T. Urquiza-Haas (Eds.), *Planeación para la conservación de la Biodiversidad terrestre en México: retos en un país megadiverso*. México DF: CONABIO & CONANP.
- Palomera-García, C., Santana, E., Contreras-Martínez, S., & Amparán, R. (2007). Jalisco (pp. 1-48). In R. Ortiz-Pulido, A. Navarro-Sigüenza, H. Gómez de Silva, O. Rojas-Soto, & T.A. Peterson (Eds.), *Avifaunas Estatales de México*. Pachuca, Hidalgo: CIPAMEX.
- Paracuellos, M., & Tellería, J. L. (2004). Factors Affecting the distribution of a waterbird community: the role of habitat configuration and bird abundance. *Waterbirds*, 27(4), 446-453.

- Peña-Villalobos, I., Fibla, P., Salazar, J. E., & Sallaberry, M. (2012). Seasonal changes in the abundance and composition of the waterbirds assemblage in artificial ponds of Central Chile. *Gayana*, 76(2), 92-101.
- Peres, C. A., & Terborgh, J. W. (1995). Amazonian Nature Reserves: An Analysis of the Defensibility Status of Existing Conservation Units and Design Criteria for the Future. *Conservation Biology*, 9(1),34–46.
- Pérez-Arteaga, A., Gaston, K. J., & Kershaw, M. (2002) Undesignated sites in Mexico qualifying as wetlands of international importance. *Biological Conservation*, 107(1), 47-57.
- Pérez-Arteaga, A., Gaston, K. J., & Kershaw, M. (2002). Population trends and priority conservation sites for Mexican Duck *Anas diazi*. *Bird Conservation International*, 12, 35-52.
- Pérez-Arteaga, A., & Gaston, K. J. (2004). Wildfowl population trends in Mexico, 1961-2000: a basis for conservation planning. *Biological Conservation*, 115(3), 343-355.
- Pickett, F. B., & Meeks-Wagner, D. R. (1995). Seeing double: appreciating genetic redundancy. *Plant Cell*, 7(9), 1347-1356.
- Pineda, R., Arellano, A., Almazán, R. C., López, C., & González, F. (2010). Nueva información para la avifauna del estado de Querétaro, México. *Acta Zoológica Mexicana*, 26(1), 47-57.
- Primack, R., Rozzi, R., Dirzo, R., & P. Feinsinger. (2001). ¿Donde se encuentra la diversidad biológica? In R. Primack, R. Rozzi, P. Feinsinger, R. Dirzo, & F. Massardo (Eds.), *Fundamentos de Conservación Biológica, Perspectivas latinoamericanas* (pp. 99-128). México DF: Fondo de Cultura Económica.

- Primack, R. B. (2002). *Essentials of Conservation Biology*. Sunderland Massachusetts: Sinauer Associates.
- Pulliam, H. R. (1988). Sources, Sinks and Population Regulation. *The American Naturalist*, 132(5), 652-661.
- R Development Core Team. (2010). R: a Language and Environment for Statistical Computing. Vienna: R Foundation for Statistical Computing. Available from: <http://www.r-project.org/> (accessed November 2013).
- Ramírez-Albores, J.E. (2007). Bird diversity and conservation of Alto Balsas (Southwestern Puebla), Mexico. *Revista de Biología Tropical*, 55(1), 287-300.
- Rojas-Soto, O., & Navarro-Sigüenza, A.G. (1999). Nueva información sobre la avifauna del Estado de Puebla, México. *Anales del Instituto de Biología, Serie Zoología*, 70, 205-213.
- Rojas-Soto, O., Sánchez-González, L.A., & López de Aquino, S. (2002). New information on birds from northern Hidalgo. *The Southwestern Naturalist*, 47, 471-475.
- Sarkar, S., & Margules, C. (2002). Operationalizing biodiversity for conservation planning. *Journal Biosciences*, 27(4), 299-308.
- Sarkar, S., Pappas, C., Garson, J., Aggarwal, A., & Cameron, S. (2004). Place prioritization for biodiversity conservation using probabilistic surrogate distribution data. *Diversity and Distributions*, 10, 125-133.
- Scott, J.M., Abbitt, R.J.F., & Groves, C.R. (2001). What are we protecting? The United States conservation portfolio. *Conservation Biology in Practice*, 2(1),18-19.

Secretaría de Medio Ambiente y Recursos Naturales, SEMARNAT (2010). Norma Oficial Mexicana (NOM-059-SEMARNAT-2010), Protección ambiental-Especies Nativas de México de Flora y Fauna Silvestres-Categorías de Riesgo y Especificaciones para su Inclusión, Exclusión o Cambio-Lista de Especies en Riesgo. Diario Oficial de la Federación. 30 de diciembre de 2010, México, DF.

Sonal, D., Jargruti, R., & Geeta, P. (2010) Avifaunal diversity and water analysis of an inland wetland. *Journal of Wetlands Ecology*, 4, 1-32.

Stotz, D.F., Fitzpatrick, J.W., Parker II, T.A., & Moskovitz, D.K. (1996). Neotropical birds: ecology and conservation, Chicago and London: University of Chicago Press.

Tear, T. H., Kareiva, P., Angermeier, P. L., Comer, P., Czech, B., Kautz, R., Landon, L., Melhman, D., Murphy, K., Ruckelshaus, M., Scott, J. M., & Wilhere, G. (2005). How Much Is Enough? The Recurrent Problem of Setting Measurable Objectives in Conservation. *BioScience*, 55(10), 835–849.

The Ramsar Convention on Wetlands (Ramsar), Comisión Nacional de Áreas Nacionales Protegidas (CONANP), Secretaría de Medio Ambiente y Recursos Naturales (SEMARNAT). (2013) Humedales de México, Humedales Mexicanos de Importancia Internacional (Sitios Ramsar). Available from: <http://ramsar.conanp.gob.mx/sitios.php> (accessed May 2012).

- Turner, M. G., Gardner, R. H., & O'Neill, R. V. (2001) Causes of Landscape Pattern. In M.G. Turner et al. (Eds.), *Landscape Ecology in theory and practice, pattern and process* (pp. 72-92). New York: Springer.
- United Nations, Convention on Biological Diversity (2004). Available from: <http://www.cbd.int/convention/text/> (accessed January 2012).
- Valencia-Herverth, J., Valencia-Herverth, R., Mendiola-González, M. E., Sánchez Cabrera, M., Martínez-Morales, M. A. (2011). New and outstanding bird records to the State of Hidalgo, Mexico. *Acta Zoológica Mexicana*, 27(3), 843-861.
- Vázquez, L. B., & Valenzuela-Galván, D. (2009). ¿Qué tan bien representados están los mamíferos mexicanos en la red federal de áreas naturales protegidas del país? *Revista Mexicana de Biodiversidad*, 80, 249-258.

CHAPTER 2

THREATS, CONSERVATION ACTIONS, AND RESEARCH WITHIN 78 MEXICAN NON-COASTAL PROTECTED WETLANDS

This Chapter was published with: De Gortari-Ludlow, N., Espinosa-Reyes, G., Rivas-Flores, J., Salgado-Ortiz, J., & Chapa-Vargas, L. (2014). Threats, conservation actions, and research within 78 Mexican non-coastal protected wetlands. *Journal for Nature Conservation*. Available from: <http://www.sciencedirect.com/science/article/pii/S1617138114000685#>

Abstract

We reviewed scientific literature and internet sources related to types of threats, conservation actions, and focus of research implemented in 78 Mexican non-coastal wetlands. These sites have been established as Natural Protected Areas, Ramsar Sites, and/or Important Bird Areas, and thus hold the highest priority for wetland conservation in Mexico. According to the information obtained, the main threats within these sites included “agriculture and aquaculture”, “biological resource use”, and “pollution”. The most commonly reported conservation action was “education and awareness”, and the least frequent were “law and policy”, as well as “livelihood, economic, and other incentives”. The most popular research focus was “site description”, whereas the least frequent were “conservation”, and “impacts”. These results suggest that both management and research fail at addressing existing threats within most sites. Our study is useful for identification of information gaps, and conservation priorities that should be set within these sites according to available information.

KEYWORDS. Mexican non-coastal wetlands, threats, conservation, research, management.

Resumen

Revisamos literatura científica y fuentes de internet relacionadas con los tipos de amenazas, acciones de conservación, y el enfoque de la investigación implementados en 78 humedales no costeros mexicanos. Estos sitios se han establecido como Áreas Naturales Protegidas, sitios Ramsar, y/o Áreas Importantes para las Aves, y por lo tanto mantienen la más alta prioridad para la conservación de humedales en México. De acuerdo con la información obtenida, las principales amenazas dentro de estos sitios incluyen "la agricultura y la acuicultura", "utilización de los recursos biológicos" y la "contaminación". La acción de conservación más frecuentemente reportada fue "la educación y la conciencia", y los menos frecuentes fueron "la ley y la política", así como "los medios de vida, económica y otros incentivos." El enfoque de la investigación más popular fue "descripción del sitio", mientras que los menos frecuentes fueron la "conservación" y los "impactos". Estos resultados sugieren que tanto la gestión y la investigación fallan en abordar las amenazas existentes en la mayoría de los sitios. Nuestro estudio es útil para la identificación de vacíos de información, y las prioridades de conservación que deberían implementarse en estos sitios de acuerdo a la información disponible.

PALABRAS CLAVE. Humedales mexicanos no costeros, amenazas, conservación, investigación, gestión.

Introduction

Throughout the world, non-coastal wetlands (i.e., land freshwater bodies located away from coastlines) are complex, dynamic, and highly productive systems that provide environmental services, and habitat for numerous species of flora and fauna and thus harbour high biodiversity values. However, it has been documented that these wetlands are often subject to different direct anthropogenic threats (“proximate human activities causing destruction, degradation or impairment of biodiversity”, defined by Salafsky et al. 2008) such as agriculture, aquaculture and livestock farming, pollution, biological resource use, exposure to invasive species, climate change, urbanisation etc. (e.g. Hartig et al. 1997; Brinson & Malvárez 2002; Zedler 2003; McLeod et al. 2013). As a result of these threats, that persist even where management is intense (Antos et al. 2007), due to lack of appreciation (Weston et al. 2006), wetlands are among the most threatened habitats globally.

The subject of the current study was non-coastal wetlands of Mexico, a mega diverse country that contains a large number of wetlands of conservation concern. We conducted our study at the national scale because management actions are usually implemented locally, but in order to meet national and international priorities, these actions should be coordinated at such large scales (Chapa-Vargas & Monzalvo-Santos 2012). To date, there is not a critical review about conservation status and research needs at the national scale. Because more than 75% of all Mexican freshwater resources are far from centers of high population density (Hardoy et al. 1992; Montero-Contreras 2009), water is often

transported long distances, thus creating an imbalance between supply, and demand for water resources. This imbalance has promoted overexploitation of aquifers and their associated resources, thus resulting in many direct anthropogenic threats to non-coastal wetlands and their associated biota (Custodio 2002; Esteller & Andreu 2005).

Establishment of ecological reserves is considered among the most effective ecosystem conservation strategies (Primack 1993). Reserve effectiveness, however, depends on the design and implementation of management actions based on sound scientific information (Margules & Pressey 2000). Consistent with what has happened in many regions of the world, the system of Mexican non-coastal wetlands is not adequately protected, partly because systematic conservation planning (*sensu* Margules & Pressey 2000) has rarely been implemented, and because most Mexican protected sites are not managed adequately (Toledo 2005; Koleff et al. 2007).

Currently, there is not a critical review related to conservation status and research needs for managed Mexican non-coastal wetlands that may guide future effort. This information gap motivated the current review. Our objective was to identify and synthesize the main direct threats, conservation actions, and research focus within Mexican non-coastal wetland sites that have been established as either, Natural Protected Areas (NPAs), Ramsar Sites, and/or Important Bird Areas (IBAs). We intended to document many types of threats present. On the other hand, we expected to find an increase through time in management actions and research studies. To determine if research focus is associated to existing threats, and if management actions are based on research findings, we also aimed at

assessing potential correlations among threats, research focus, and conservation actions. Based on previous reports of insufficient management for most Mexican protected areas (see above), we predicted that correlations among these three variables would be not significant or weak. Finally, we discuss potential driving forces (“the ultimate factors, usually social, economic, political, institutional, or cultural, that enable or otherwise add to the occurrence or persistence of direct threats”, defined by Salafsky et al. 2008) that have determined the trends that we identified. Therefore, this work should aid managers from both government and non-government agencies to identify within-site conservation strategies, as well as research priorities and strategies at the national scale. Our results could also serve as a source of motivation for strengthening communication between land managers and members of the academic community not only in Mexico but in other regions facing similar conservation challenges.

Methods

Our study comprised 78 Mexican non-coastal wetlands that have been established as NPAs, Ramsar Sites, and/or IBAs (Figure 2.1.).

Figure 2.1. Location of 78 Protected non-coastal Mexican wetlands.

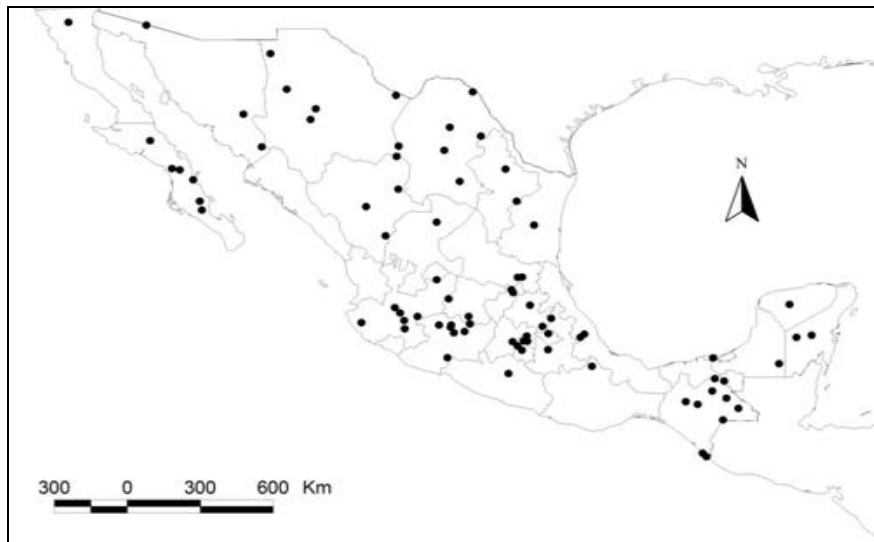

Databases

We constructed three databases containing information related to; 1) direct threat types, 2) conservation actions, and 3) focus of research implemented within each of the 78 non-coastal wetlands included in the study. We also obtained information related to year in which each wetland was established for the first time either as NPA, Ramsar, and/or IBA, and year in which a management plan for each of these sites was published. In addition, for each site we identified the Level 1 ecoregion in which it is located (INEGI et al. 2008). All information was obtained from technical sheets of Ramsar wetlands (The Ramsar Convention on Wetlands 2013), the IBAs

of Mexico (Arizmendi & Márquez-Valdelamar 2000; CONABIO 2002), description sheets from the National Commission for the Knowledge and Use of Biodiversity (CONABIO 1995), and from scientific publications (Arriaga-Cabrera et al. 1997; Ramírez-Albores 2007; Rojas-Soto & Navarro-Sigüenza 1999; Rojas Soto et al. 2002). The information in each database was organised systematically into different categories based on direct threat, and conservation action classifications previously established by Salafsky et al. (2008). We adopted this classification scheme because it integrates previous efforts from the Conservation Measures Partnership (CMP 2005), and from the International Union for the Conservation of Nature (IUCN 2005a, 2005b), and because it is intended to be simple, hierarchical, comprehensive, consistent, expandable, exclusive, and scalable. Therefore, it is of universal applicability, and is intended for standardisation, thus allowing comparisons among studies. We also defined categories for focus of research that would be related to the threat and conservation action categories that we used. Thus, we included the following level 1 and 2 categories (level 2 categories within each level 1 category are shown in parentheses). 1) Direct threats to the native biota and their habitats included eight level 2 categories: agriculture and aquaculture (annual and perennial no timber crops, and livestock farming and ranching), energy production and mining (mining and quarrying), transportation and service corridors (roads and railroads), biological resource use (hunting and collecting terrestrial animals, gathering terrestrial plants, logging and wood harvesting, and fishing and harvesting of aquatic resources), human intrusions and disturbance (recreational activities), natural system modifications (dams and water management/use), invasive and other problematic species and genes (invasive

non-native/alien species), pollution (household sewage and urban waste water, industrial effluents, agricultural and forestry effluents, garbage and solid waste, and excess energy), and climate change and severe weather (droughts, storms, and flooding). 2) Conservation actions were grouped into six level 1 categories: land/water protection (resource and habitat protection, site/area management, and habitat and natural process restoration), species management (management for individual species conservation, species recovery, and ex situ conservation), education and awareness (formal education, training, and awareness and communications), law and policy (legislation, policies and regulations, and compliance and enforcement), livelihood, economic and other incentives (linked enterprises and livelihood alternatives, and substitution), and external capacity building (institutional and civil society development, alliance and partnership development, and conservation finance). 3) Focus of research included three level 1 categories: descriptive studies (biodiversity indices, monitoring, taxonomy, flora and fauna auto ecological studies, climate, abiotic aspects, conservation status, sociological and environmental studies, and policy problems), conservation (management, ecotourism, ethno biology, environmental education, and land/water management), and impacts studies about current or potential risks (biological invasions, hunting, fishing, logging and gathering of plants, climate change, pollution, land use change and vegetation perturbation, and urban impacts within sites). Not all information was available for all categories. Thus, study sites with missing data points were excluded from some statistical analyses, and consequently sample sizes vary among analyses.

We constructed scatterplots depicting: 1) number of sites established as NPAs, Ramsar, and/or IBAs per year, 2) number of management plans per year, and 3) number of published research studies per year. Regression curves showing the best fit to the data (see below) are depicted in these plots. We also generated bar graphs showing: 1) number of sites reporting different level 1 categories of direct threats, and conservation actions, 2) number of level 2 direct threats, and conservation actions per site, and 3) number of level 2 conservation actions, established sites, and management plans within each level 1 ecoregion. Finally, we report number of level 2 research actions per site.

Statistical analysis

Summary statistics are presented as untransformed means \pm standard deviations. All statistical analyses were performed using R (R Development Core Team 2010). To identify temporal trends in yearly rates of site establishment, publication of management plans, and publication of studies through time, we conducted simple linear, quadratic, and exponential regressions to assess the change in these variables through time. For these analyses we specified the poisson distribution which is the most appropriate for count data which usually fail at fitting the normal distribution (Crawley 2005). However, whenever overdispersion was evidenced as indicated by larger residual deviance in comparison to degrees of freedom, quasipoisson distribution was specified as recommended by Burnham and Anderson (2002), and by Crawley (2005). In order to select among the three linear models (linear, quadratic, and exponential) for each analysis, we chose the model receiving the greatest support from the data based on the Akaike Information

Criterion (AIC). AIC was estimated through maximum likelihood (see Burnham & Anderson 2002 for details), and the linear model having the smallest AIC value was considered as the best-supported model. For two analyses (number of published management plans, and published studies vs. year, see below), two models received equivalent support from the data (AIC difference between models was < 2 AIC units, e.g. Burnham & Anderson 2002). By inspecting scatterplots of these data we realised that this effect resulted when average number of publications or published management plans per year through a long time period was ≤ 1 , but a few years had two or three publications. This produced a pattern similar to that of an exponential relationship, but visual inspection of the scatterplot revealed a linear trend. This is an indication of fads (see below), and thus we selected the lineal model in both cases. Regarding number of published studies per year, we found that up to 1966, only a very limited number of studies were published yearly. Thereafter, however, the rate of publications per year rapidly increased (see results section). Therefore, we ran two regressions; one including studies published before 1967, and the second focusing in studies published after 1966. For time-series data such as these, 'fads' may arise, which consist of short time periods with high rates in values of the interest variable (Abraham & Hines 2006), which in our case were establishment of sites, publication of management plans, and/or published scientific studies. Fads represent deviations from trends that are defined as consistent, long-term change in general direction. Thus, we inspected our data to identify fads, and discriminated these from trends which were characterised by a statistically significant fit of a curve or line exhibiting consistent change through time (e.g. Yarwood et al. 2014).

In addition to the temporal analyses, we evaluated whether proportion of sites reporting threats, conservation actions, and sites having been the subject of scientific studies varied among threat types, conservation action categories, and research categories, respectively, using proportion tests (Crawley 2005). To determine whether the number of established sites is homogeneous among federal government periods, and if the number of established sites, management plans, and conservation actions are homogeneous among level 1 ecoregions, chi-square tests for homogeneity were conducted.

Linear regressions were performed to evaluate the strength of two-way relationships between direct threats, conservation actions, and research actions. Poisson was used as the distribution for these analyses. However, whenever we found evidence of overdispersion quasipoisson distribution was used. For all poisson regressions we used chi-square goodness of fit tests (GOF) to assess to what extent the models fit the data. Whenever there is indication of lack of fit between the model and the data, as indicated by a small P value (<0.05), the results should be interpreted with caution.

Results and discussion

We obtained information from 1875 sources, 104 of which refer to types of risks and conservation actions within individual sites. The remaining 1771 are scientific publications. In average, each study referred to 1.82 ± 2.95 sites.

1936 was the first year in which a non-coastal site, the Zempoala Lagoon, was established as a protected area. The change in establishment of new sites showed a quadratic trend (AIC=243.3, vs. 247.6 for lineal and exponential models, regression coefficients: lineal=-3.2, quadratic=0.0008, $P < 0.001$); from the 1930s through to the 1980s, few sites were established (0.28 ± 0.58 sites per year). The rate of establishment of new sites, however, increased after the mid 1990s (Fig. 2.2.) (3.59 ± 5.87 per year). During the last eight decades, several periods of eight-to-17 consecutive years with no new established sites took place, and apparently four fads (1936-1941, 1959-1962, 1978-1980, 1999-2009) took place (Fig. 2.2). One extreme value was registered for 1999, the year in which all the IBAs were established (Arizmendi & Márquez-Valdelamar 2000), and several fads occurred, in the late 30s and early 40s, early 60s, early 90s, and during the last 13 years (Fig. 2.2). Due to the presence of these fads, the model fit was poor (GOF, $X^2=167.93$, $df=74$, $P < 0.001$). Interpretation of temporal data has limitations because drivers of change are, at best, inferred (Yarwood et al. 2014). Trends in establishment of new sites may have resulted from changes in federal government plans between consecutive governments, which in Mexico change every six years; in fact the number of new established sites was not homogeneous among

government periods ($X^2=200.3$, $df=12$, $P<0.001$), with five periods having no new established sites (1946-1952, 1952-1958, 1964-1970, 1970-1976, and 1982-1988), and three periods having a large number of established sites (>10 ; 1994-2000, 2000-2006, and 2006-2012, Fig. 2.2). Of the 78 sites included in our study, only 28 have management plans. The first management plan for an individual site was published in 1995. Thereafter, one new management plan was published every year, with the exceptions of 2001 with two management plans, and both 1997 and 2010, when no management plans were published (Fig. 2.2). Therefore, the lineal model received the best support from the data (AIC=41.3 vs. 43.04 for the quadratic model). The lineal model suggested that there were no significant changes in rates of publication of management plans through time (lineal regression coefficient=-0.005, $P=0.91$), and the fit of this statistical model was good (GOF, $X^2=4.70$, $df=15$, $P=0.99$).

Figure 2.2. Number established sites through time (black dots) and number of published management plans through time (gray triangles). Best fit poisson regression trends are shown for established sites (dotted line), and management plans (black line).

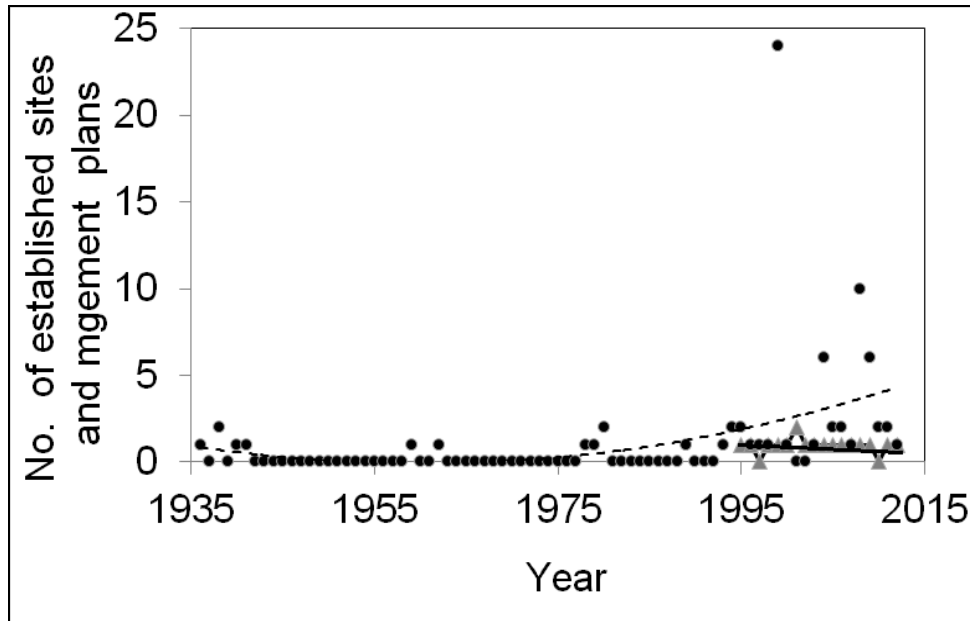

The main driver for the establishment of both protected sites, and publication of management plans starting in 1995 may have been the signing of the Convention on Biological Diversity (United Nations 1992), and the Conference of the Parties (COP 1994). Signatory nations to these agreements have approved implementation specific biodiversity conservation actions, including the establishment of biological reserves and management plans. It is likely that the signing of international agreements may have also positively influenced the establishment of conservation actions in both aquatic and other ecosystem types of other countries around the globe. The number of sites established as NPAs, Ramsar, and/or IBAs, and published management plans within ecoregions was

13.00 \pm 8.90, and 4.70 \pm 2.40 respectively. These numbers were not homogeneous among ecoregions (established sites: $X^2=55.70$, $df=6$, $P<0.01$; management plans: $X^2=13.50$, $df=6$, $P=0.04$). The "Temperate Mountains" ecoregion had the largest number of established sites and management plans (Fig. 2.3.). Temperate Mountains are located at high elevations having difficult access. It has been previously reported elsewhere that biological reserves are often established in remote sites with difficult access, but remoteness may not necessarily be associated with all ecological processes that require protection (Margules & Pressey 2000; Chapa-Vargas & Monzalvo-Santos 2012). Therefore, other types of ecosystems located in most other ecoregions should be evaluated for their usefulness for conservation of biological diversity. The Mediterranean californian ecoregion, for instance, did not contain any protected non-coastal wetlands. These results are consistent with previous findings suggesting that natural reserves are insufficient to represent biodiversity both in Mexico (Conabio-Conanp-TNC-PRONATURA-FC & UANL 2007; Fuller et al. 2007; Figueroa & Sánchez-Cordero 2008) and in other parts of the globe (Scott et al. 2001).

Figure 2.3. Number of established sites (white bars), management plans (grey bars) and conservation actions (black bars) per level 1 ecoregion. Ecoregion abbreviations are as follows: NAD=North American Deserts, MSE= Midland Semiarid Elevations, GP= Great Plains, WDF= Warm Dry Forests, MHF= Moist Hot Forests, and TM=Temperate Mountains.

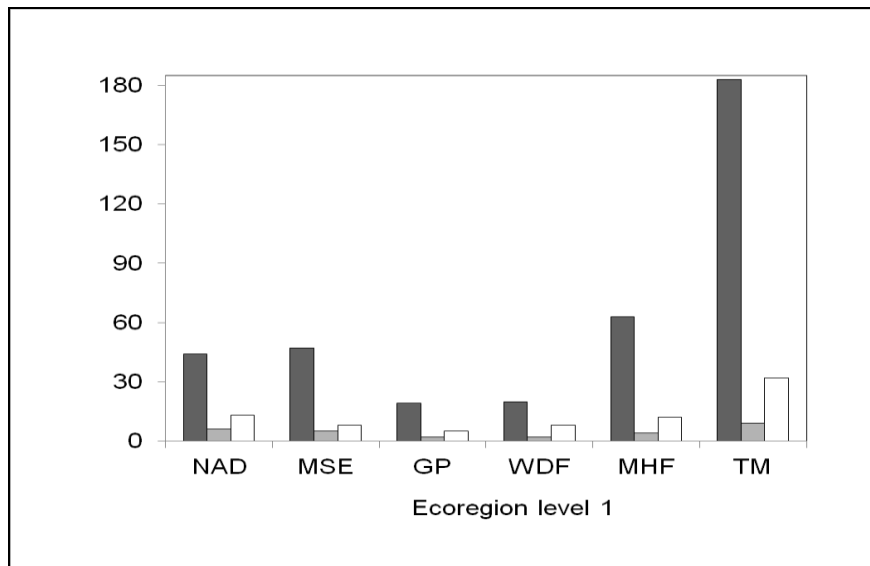

The number of reported level 2 direct threats was 7.45 ± 2.77 per site. Direct threats are indeed quite common in most sites (Fig. 2.4). Proportion of sites reporting threats varied among threat types (proportion test, $X^2=248.90$, $df=8$, $P<0.01$). Agriculture and aquaculture, biological resource use, and pollution were the most reported level 1 direct threats for >60% of all sites, whereas energy production and mining, and climate change and severe weather were the least reported (Fig. 2.5). Agriculture is indeed among the major causes of loss of

vegetative cover near non-coastal wetlands in different regions of the world (Hartig et al. 1997; Cortina-Villar et al. 1999; Brinson & Malvárez 2002; Zedler 2003).

Figure 2.4. Number of level 2 direct threats (black bars), and conservation actions (grey bars) per site.

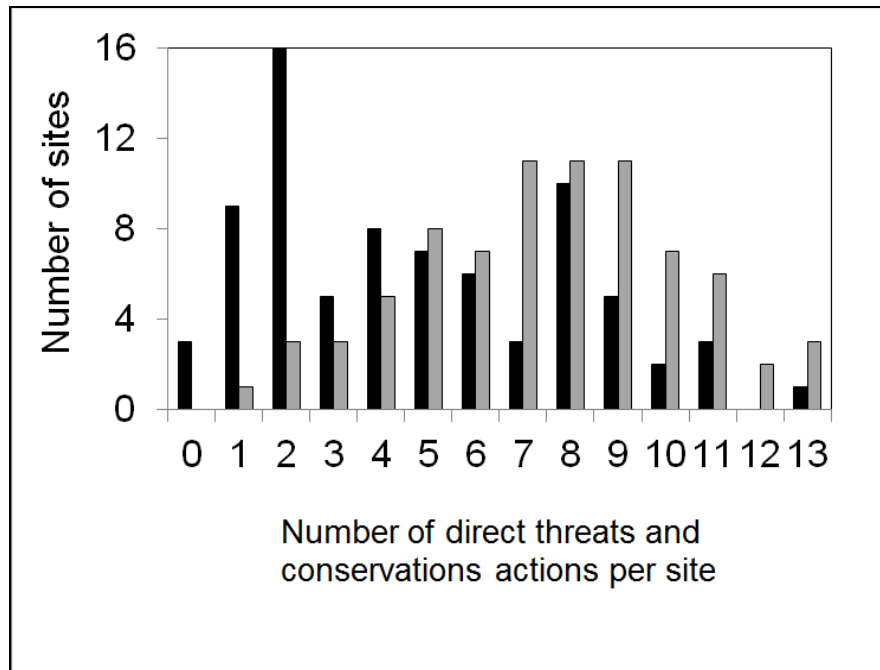

Government institutional programs are strong drivers for the increase in agriculture in Mexico (García-Barríos et al. 2009; Ribeiro-Palacios et al. 2013). For at least the last four decades, the Mexican government has implemented programs promoting establishment of agricultural complexes, some examples of these programs include “Procampo”, a program which sponsored agrarian development throughout the country (Support Programs SAGARPA, 2014), and the National Program of Agrarian Certification (Certification Program of Ejido Rights and Titling of Urban Plots) which accentuated the smallholder regime, the privatisation of the

sugarcane industry, and the creation of private agribusinesses in Northern Mexico for the production of garden vegetables for export in the 1990s. Many other programs such as the Support Program for Investment in Equipment and Infrastructure from SAGARPA (the Department of Agriculture, Livestock Farming, Rural Development, Fisheries, and Feeding) have promoted aquaculture (programs subject to operating rules with fisheries and aquaculture components 2013). Ultimately, the exponential population growth during the last decades (Repetto 1989; Appendini 1994; Torres-Torres & Gasca Zamora 2001) has increased the demand for food. Because long-term persistence of resources depends largely on the type of agriculture either traditional, and/or extensive, and because the same happens with livestock intensity (Toledo et al. 1989; Betancourt-Yáñez & Pulido 2006), alternative practices promoting diversity of habitats within the agricultural matrix at the landscape-level should be implemented. Such diverse landscapes maintain alternative feeding resources for the long term viability of wildlife populations, even in fragmented ecosystems (Medici & Desbiez 2012). Considering that natural reserves are insufficient to represent all biodiversity, conservation should also be implemented outside reserves (Sepúlveda et al. 1997; Guevara & Laborde 2009).

Logging is an important economic activity because it provides timber and energy. However, the use of this resource is a growing threat as it is linked with deforestation, alteration of natural fire regimes, hunting and trade of wildlife species, as well as wild flora extraction for ornamental purposes. This result is consistent with previous studies that have identified biological resource uses as some of the main threats to non-coastal wetland habitats elsewhere (Kiringe et al.

2007; Salafsky et al. 2008; Battisti et al. 2008). In Mexico there is a lack of awareness about which species are at risk. We believe that the absence of law enforcement personnel and infrastructure, and the demand for timber are likely among the main drivers for biological resource use in Mexico. In addition there is a lack of ecological and biological knowledge about proper management techniques for wild populations (Iñigo & Enkerlin 2003).

Another problem requiring a quick solution is pollution. Sources of contamination are diverse (agrochemicals, solid waste, garbage, etc.), but most ecotoxicological studies in Mexico have focused on chemical and biological pollution (Cardona et al. 1993; Rivera- Rodríguez et al. 2007; Espinosa-Reyes et al. 2014), and even this research is scarce taking into account the magnitude of the problem. Population growth, immigration to cities and industrialisation may be drivers of increased pollution (De Bauer & Krupa 1990; Cramer 1998).

The number of level 2 conservation actions was 4.79 ± 3.27 per site (Fig. 2.4). Proportion of sites reporting conservation actions varied among conservation action categories (proportion test, $X^2=112.90$, $df=5$, $P<0.01$). Education and awareness, and species management were the most common level 1 conservation actions, and were reported for 70% and 57% of all sites, respectively (Fig. 2.5).

Figure 2.5. Number of sites reporting different types of level 1 direct threats (black bars, capital letters), and conservation actions (grey bars, lower case letters). Threat categories are as follows: AGR=Agriculture and aquaculture, EP= Energy production and mining, TRS=Transportation and service corridors, BRU= Biological resource use, HI=Human intrusions and disturbance, NSM= Natural systems modifications, IPSP=Invasive and other problematic species and genes, POLL=Pollution, and CCW=Climate change and severe weather. Conservation actions categories are as follows: lwm= Land water and management, spm= Species management, ea= Education and awareness, lpol= Law and policy, lhei=Livelihood, economic and other incentives, and ecb=External capacity building.

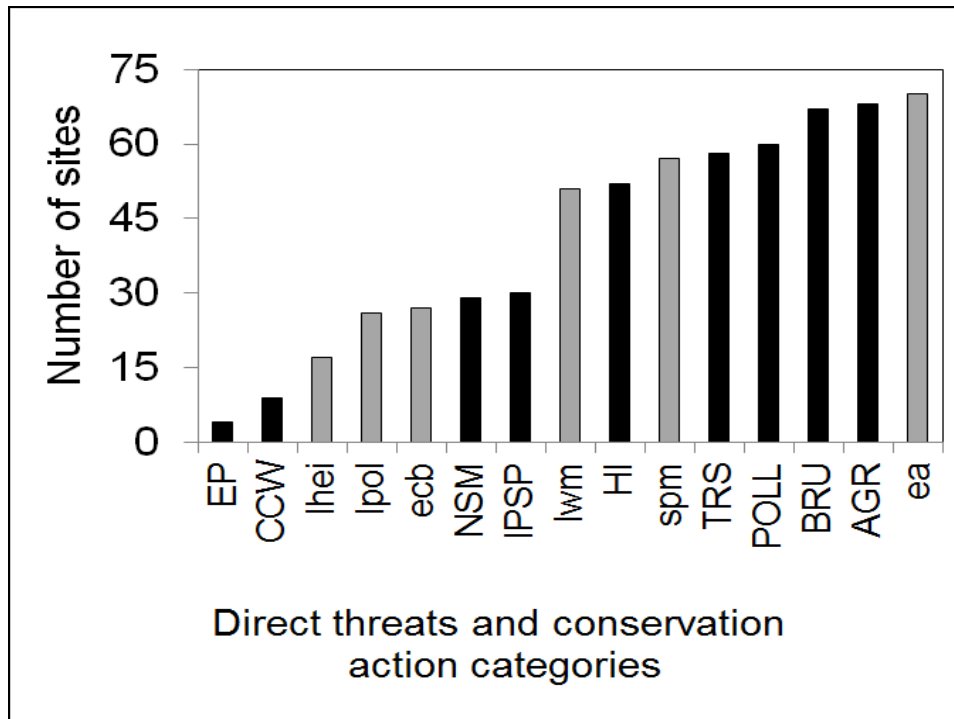

Because conservation actions within these sites are common, we believe that the establishment of NPAs, Ramsar Sites, and/or IBAs indeed promotes the implementation of conservation activities. From all conservation actions, however, education and awareness is the one that contributes the least to directly avoiding and/or reverting the effects of the direct threat types that were identified as the most important (see above), and it is not completely related to the drivers that were discussed above. In fact, these threat types require implementation of conservation actions focused not only at the individual species level, but also centered on ecosystems and entire sites. These last types of actions were only reported for $\leq 51\%$ of all sites (Fig. 2.5.), thus suggesting that conservation actions partially fail at addressing specific threats and do not focus on drivers that are the most important factors that should be addressed. Activities attempting to mitigate the effects of agriculture and aquaculture, biological resource use, and pollution are indeed lacking in most sites. In addition, we found that the number of conservation actions was only related to number of threats per site (regression coefficient=0.03, $P=0.08$), and that the fit of this statistical model was very weak (GOF, $X^2=178.26$, $P<0.01$). Overall, this result confirms conclusions from previous studies (Brandon & Wells 1992; Schwartzman et al. 2000) as it indicates that the objectives for which most of these reserves were established have not yet been completely fulfilled.

Only a few research studies have been conducted in most individual sites (22.70 ± 25.03 , mode=1, Fig. 2.6.), suggesting that research is also insufficient.

Figure 2.6. Number of published studies per site.

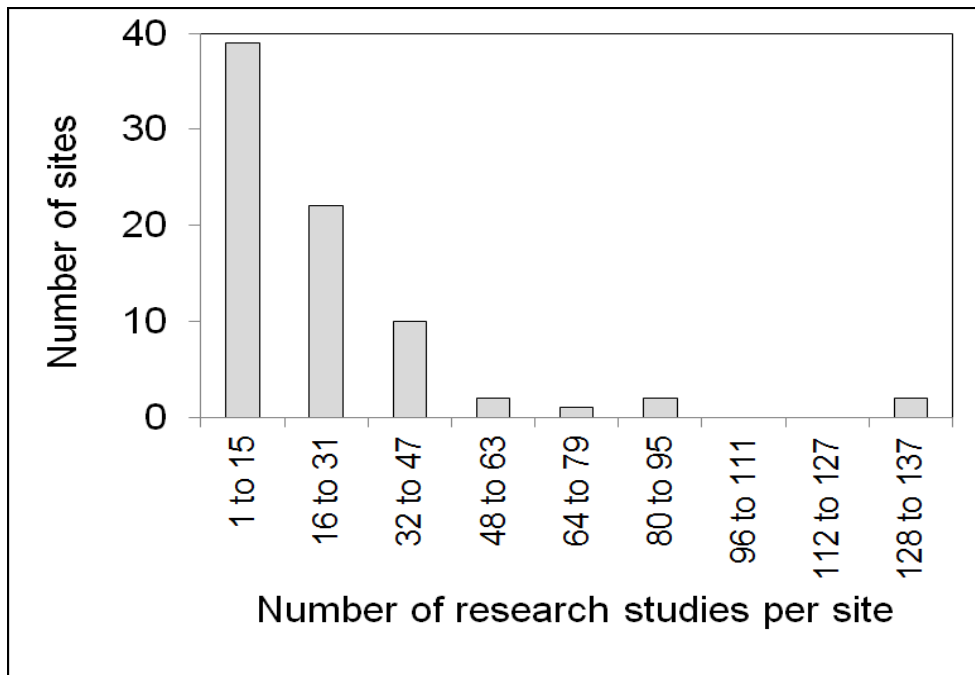

From 1857 until 1966, the number of published studies per year was very moderate. For this period, the lineal model received the best support from the data (AIC=98.28 for lineal vs. 100.26 for the quadratic model) with a very subtle increase (regression coefficient=0.03, $P < 0.001$), and the fit of this model was good (GOF, $X^2 = 62.06$, $df = 108$, $P = 0.99$). For the period starting in 1967, the quadratic model received the best support from the data (AIC=285.48 for quadratic vs. 315.99 for exponential and lineal models). This model indicated that publication rate increased significantly within this period (regression coefficients, lineal=6.27, quadratic=-0.002, $P < 0.001$) and the fit of this model was low due to the presence of several fads (GOF, $X^2 = 79.7$, $df = 43$, $P < 0.01$, Fig. 2.7.). Proportion of sites having been the subject of scientific studies varied among research categories (proportion

test, $X^2=31.29$, $df=2$, $P<0.01$). Whereas descriptive studies have been conducted in all sites, investigations pertaining to the conservation and impacts categories within individual sites are less frequent (61 % and 51 % of all sites, respectively).

Figure 2.7. Number of published studies per year combining all sites, poisson regression trends are shown for the 1857-1966 (black dots, white line), and 1967-2013 (grey triangles, grey line).

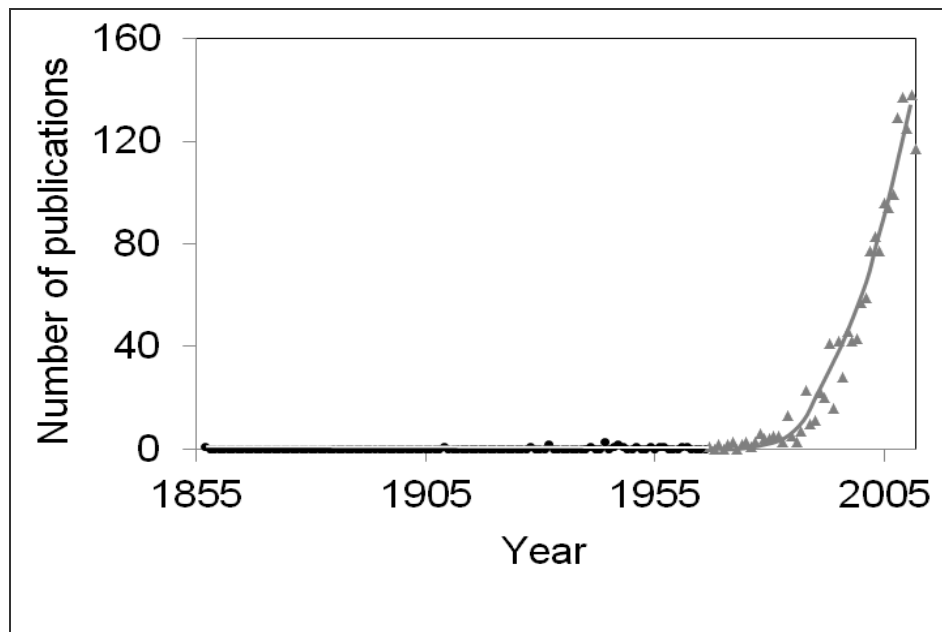

Environmental studies, ethnobiology and ecotourism should also be implemented because traditional management practices promote self-sufficient communities at local scales and simultaneously maintain healthy ecosystems (Browner 1985; Berkes et al. 2000). The number of research actions did not vary significantly with number of threats per site (regression coefficient=0.07, $P=0.143$), and the model did not fit the data (GOF, $X^2=1466.7$, $df=76$, $P<0.001$). Finally, number of conservation actions increased with number of research actions per site, but only the rate of this increase was negligible (regression coefficient=0.005, $P=0.03$), and

this model did not fit the data well (GOF, $\chi^2=175.9$, $df=76$, $P<0.001$). These results are consistent with our predictions. As far as we are aware, no previous studies have correlated research with management and/or threats. However, from the conservation standpoint it is important to determine to what extent research is influencing conservation management actions and if it is contributing to decrease threats elsewhere. It is evident that conservation actions and research within most reserves analysed in the current study are insufficient because management actions and research are unrelated to the needs that specific threats require.

Conclusions and conservation implications

We found that scientists and managers in Mexico have failed at addressing some important threats such as agriculture and aquaculture, biological resource use, transportation and service corridors, and human intrusions and disturbance. This is unfortunate, especially considering that the Mexican Government has signed international biodiversity conservation agreements and has taken specific steps, such as the establishment of ecological reserves and management plans, for promoting natural resources conservation. In Mexican non-coastal wetlands, however, monitoring is generally infrequent and not comprehensive, and so is management. Therefore, the establishment of reserves and the creation of management plans do not necessarily promote implementation of sound management actions. For the particular case of Mexico, the failure to implement successful conservation actions may be directly linked to an apparent lack of communication between scientists and managers, and it is still to be seen if this trend holds for other regions of the world. Scientists and managers need to understand each other. Therefore, a new generation of professionals able to understand both the language and rigor of scientists, and the needs of managers may be required. Given that impacts in non-coastal aquatic reserves of Mexico are quite common, it is surprising that research attempting to understand these impacts is the least frequent. Because individual sites differ in biotic and abiotic factors, as well as disturbance and its effects on biota, individual studies in each site are needed. Local threats differ among sites in scope, severity, duration,

frequency, irreversibility, etc. These qualities can be quantified and summarised through risk analysis methodologies, and the resulting information can be used by managers in collaboration with scientists to develop conceptual frameworks to facilitate standardisation of assessments of the relative magnitude of different threats on a site-by site basis (e.g. Kiringe et al. 2007; Battisti et al. 2008, 2009). This type of methodology is useful for defining conservation priorities, and to guide future conservation efforts and their application in Mexico and it would likely promote wetland conservation, especially if managers and scientists strengthen their collaboration.

Acknowledgements

Two anonymous reviewers provided valuable recommendations to improve the overall quality of an earlier version of the manuscript.

References

- Abraham, D., & Hines, A. (2006). The 'trend' before the storm: How to use trend analysis and foresight to improve New Product Development success rates. *Visions*, 30(4), 19–21.
- Antos, M.J., Ecmhke, G.C., Tzaros, C.L., & Weston, M. (2007). Unauthorized human use of an urban coastal wetland sanctuary: Current and future patterns. *Landscape and Urban Planning*, 80, 173-183.
- Appendini, K. (1994). Agricultural policy, climate change and food security in Mexico. *Food Policy*, 19(2), 149-164.
- Arizmendi, M.C., & Márquez-Valdelamar, L. (Eds.). (2000). *Áreas de Importancia para la Conservación de las Aves en México*. México DF: CONABIO & CIPAMEX.
- Arriaga-Cabrera, L., Díaz, S., Domínguez, R., & León, J.L. (1997). Composición florística y vegetación. In L. Arriaga, & R. Rodríguez Estrella (Eds.), *Los oasis de la península de Baja California* (pp. 69-106). La Paz Baja California Sur, México: SIMAC & CIBNOR.
- Battisti, C., Luiselli, L., Pantano, D., & Teofili, C. (2008). On threats analysis approach applied to a Mediterranean remnant wetland: is the assessment of human-induced threats related to different level of expertise of respondents? *Biodiversity Conservation*, 17, 1529-1542.

- Battisti, C., Luiselli, L., & Teofili, C. (2009). Quantifying threats in a Mediterranean wetland: are there any changes in their evaluation during a training course? *Biodiversity Conservation*, 18, 3053-3060.
- Berkes, F., Colding, J., & Folke, C. (2000). Rediscovery of Traditional Ecological Knowledge as Adaptive Management. *Ecological applications*, 10(5), 1251-1262.
- Betancourt-Yáñez, P., & Pulido, P. (2006). Actitud de los agricultores hacia el manejo y conservación del suelo y agua en dos comunidades rurales del Estado Lara, Venezuela. *Bioagro*, 18(3), 155-161.
- Brandon, K.E., & Wells, M. (1992). Planning for people and parks: Design dilemmas. *World Development*, 20(4), 557-570.
- Brinson, M.M., & Malvárez, A.I. (2002). Temperate freshwater wetlands: types, status, and threats. *Environmental Conservation*, 29(2), 115-133.
- Browner, C.H. (1985). Plants used for reproductive health in Oaxaca, Mexico. *Economic Botany*, 39 (4), 482-504.
- Burnham, K.P., & Anderson, D.R. (2002). *Model selection and multimodel inference: a practical information theoretic approach*. (2th ed.). New York: Springer, (Chapter 2).
- Cardona, A., Carrillo, J.J., & Armienta, M. (1993). Elemento traza: contaminación y valores de fondo en aguas subterráneas de San Luis Potosí, SLP, México. *Geofísica Internacional*, 32(2), 277-286.
- Chapa-Vargas, L., & Monzalvo-Santos, K. (2012). Natural protected areas of San Luis Potosí, Mexico: ecological representativeness, risks, and conservation

- implications across scales. *International Journal of Geographical Information Science*, 26(9), 1625-1641.
- CMP (Conservation Measures Partnership). (2005). *Taxonomies of direct threats and conservation actions*. Washington, DC: CMP.
- Comisión Nacional para el Conocimiento y Uso de la Biodiversidad (CONABIO). (1995). In Instituto Nacional de Ecología & SEMARNAP (Eds.), *Atlas de Reservas de la biosfera y otras áreas naturales protegidas*. México.
- Comisión Nacional para el Conocimiento y Uso de la Biodiversidad (CONABIO). (2002). Acceso a la información de cada AICA por lista. Comisión Nacional para el Conocimiento y Uso de la Biodiversidad. Available from: <http://conabioweb.conabio.gob.mx/aicas/doctos/aicaslista.html> (accessed November 2013).
- CONABIO-CONANP-TNC-PRONATURA-FC & UANL. (2007). *Análisis de vacíos y omisiones en conservación de la biodiversidad terrestre de México: espacios y especies*. México: Comisión Nacional para el Conocimiento y Uso de la Biodiversidad, Comisión Nacional de Áreas Naturales Protegidas/México, The Nature Conservancy-Program México, Pronatura, A.C., & Facultad de Ciencias Forestales, Universidad Autónoma de Nuevo León, (Chapter 4).
- Conference of the Parties. (COP 1994). Available at <https://www.cbd.int/cop/> (accessed 8.03.14).
- Cortina-Villar, S., Mendoza, P., & Himmelberger, M. (1999). Cambios en el uso del suelo y deforestación en el sur de los estados de Campeche y Quintana Roo, México. *Investigaciones geográficas*, 38, 41-56.

- Cramer, J.C. (1998). Population growth and air quality in California. *Demography*, 35(1), 45-56.
- Crawley M. (2005). *Statistics, an introduction using R*. West Sussex, England: Willey & Sons, (Chapter 13).
- Custodio, E. (2002). Aquifer overexploitation: what does it mean? *Hydrogeology Journal*, 10(2), 254-277.
- De Bauer, L.I., & Krupa, S.V. (1990). The Valley of Mexico: summary of observational studies on its air quality and effects on vegetation. *Environmental Pollution*, 65(2), 109-118.
- Espinosa-Reyes, G., González-Mille, D.J., Ilizaliturri-Hernández, C.A., Mejía-Saavedra, J., Cilia-López, V.G., Costilla-Salazar, R., & Díaz-Barriga, F. (2014). Effect of Mining Activities in Biotic Communities of Villa de la Paz, San Luis Potosi, Mexico. *BioMed Research International*, 1-13.
- Esteller, M.V., & Andreu, J.M. (2005). Anthropic effects on hydrochemical characteristics of the Valle de Toluca aquifer (central Mexico). *Hydrogeology Journal*, 13(2), 378-390.
- Figueroa, F., & Sánchez-Cordero, V. (2008). Effectiveness of natural protected areas to prevent land use and land cover change in Mexico. *Biodiversity Conservation*, 17, 3223–3240.
- Fuller, T., Sánchez-Cordero, V., Iloldi-Rangel, P., Linaje, M., & Sarkar, S. (2007). The cost of postponing biodiversity conservation in Mexico. *Biological Conservation*, 134, 593-600.
- García-Barrios, L., Galván-Miyoshi, Y.M., Valdivieso-Pérez, I.A., Masera, O.R., Bocco, G., & Vandermeer, J. (2009). Neotropical forest conservation,

- agricultural intensification, and rural out-migration: the Mexican experience. *BioScience*, 59 (10), 863–873.
- Guevara, S., & Laborde, J. (2009). El enfoque Paisajístico en la Conservación: Rediseñando las reservas para la Protección de la Diversidad Biológica y Cultural en América Latina. *Environmental Ethics*, 30, 33-44.
- Hardoy, J.E., Mitlin, D., & Satterhwaite, D. (1992). *Environmental problems in Third World cities*. London: Earthscan, (Chapter 4).
- Hartig, E.K., Grozev, O., & Rosenzweig, C. (1997). Climate change, agriculture and wetlands in Eastern Europe: Vulnerability, adaptation and policy. *Climatic Change*, 46, 101-121.
- Instituto Nacional de Estadística, Geografía e Informática (INEGI), Comisión Nacional para el Conocimiento y Uso de la Biodiversidad (CONABIO), Instituto Nacional de Ecología (INE) (2008). Available from: <http://www.conabio.gob.mx/informacion/gis/> (accessed November 2013).
- Iñigo, E.E., & Enkerlin, E.C. (2003). Conservación de Aves: experiencias en México. In H. Gómez de Silva, & A. Oliveras de Ita (Eds.), *Amenazas, estrategias e instrumentos para la conservación de las aves* (pp. 86-132). México: National Fish and Wildlife Foundation, CIPAMEX, & CONABIO.
- IUCN (World Conservation Union). (2005a). Threats authority file. Version 2.1. IUCN Species Survival Commission, Cambridge, United Kingdom. Available from: <http://iucn.org/webfiles/doc/SSC/RedList/AuthorityF/threats.rtf> (accessed March 2014).
- IUCN (World Conservation Union). (2005b). Conservation actions authority file. Version 1.0. IUCN Species Survival Commission, Cambridge, United

Kingdom. Available from:

<http://iucn.org/webfiles/doc/SSC/RedList/AuthorityF/consactions.rtf>

(accessed March 2014).

Kiringe, J.W., Okello, M.M., & Ekajul, S.W. (2007). Managers perceptions of threats to the protected areas of Kenya. *Applied Ecology Environment*, 5, 49-62.

Koleff, P., Tambutti, M., March, I., Esquivel, R., Cantú, C., Lira-Noriega, A., & Moreno, N. (2007). Análisis de vacíos y omisiones en conservación en México. In R. Dirzo, R. González, & I. March (Eds.), *Capital natural y bienestar social: Segundo Estudio de Países*. México: CONABIO.

Margules, C., & Pressey, R.L. (2000). Systematic conservation planning. *Nature*, 405, 243–253.

McLeod, E.M., Guay, P.J., Taysom, A.J., Robinson, R.W., & Weston, M.A. (2013). Buses, Cars, Bicycles and Walkers: The Influence of the Type of Human Transport on the Flight Responses of Waterbirds. *PLOS One*, 8(12), 1-10.

Medici, E.P., & Desbiez, A.L.J. (2012). Population viability analysis: using a modeling tool to assess the viability of tapir populations in fragmented landscapes. *Integrative Zoology*, 7(4), 356-372.

Montero-Contreras, D. (2009). La disponibilidad de agua en México y la participación de los grandes conglomerados internacionales. *Denarius*, 103-126.

Programs subject to operating rules with fisheries and aquaculture components. (2013). Support Program for Investment in Equipment and Infrastructure,

SAGARPA. Available from:

http://www.conapesca.sagarpa.gob.mx/wb/cona/programas_sujetos_a_reglas_de_operacion (accessed April 2014).

Primack, R.B. (1993). *Essentials of conservation biology*. Sunderland, MA: Sinauer Associates.

R Development Core Team. (2010). R: a Language and Environment for Statistical Computing. Vienna: R Foundation for Statistical Computing. Available from: <http://www.r-project.org/> (accessed March 2014).

Ramírez-Albores, J.E. (2007). Bird diversity and conservation of Alto Balsas (Southwestern Puebla), Mexico. *Revista de Biología Tropical*, 55(1), 287-300.

Repetto, R. (1989). Renewable resources and population growth: Past experiences and future prospects. *Population and Environment*, 10(4), 221-236.

Ribeiro-Palacios, M., Huber-Sannwald, E., García-Barrios, L., Peña de Paz, F., Carrera-Hernández, J., & Galindo-Mendoza, M.G. (2013). Landscape diversity in a rural territory: Emerging land use mosaics coupled to livelihood diversification. *Land Use Policy*, 30, 814-824.

Rivera-Rodríguez, L.B., Rodríguez-Estrella, R., Ellington, J.J., & Evans, J.J. (2007). Quantification of low levels of organochlorine pesticides using small volumes (<100 mL) of plasma of wild birds through gas chromatography negative chemical ionization mass spectrometry. *Environmental Pollution*, 148, 654-662.

Rojas-Soto, O., & Navarro-Sigüenza, A.G. (1999). Nueva información sobre la avifauna del Estado de Puebla, México. *Anales del Instituto de Biología, Serie Zoología* 70, 205-213.

- Rojas-Soto, O., Sánchez-González, L.A., & López de Aquino, S. (2002). New information on birds from northern Hidalgo. *The Southwestern Naturalist*, 47, 471-475.
- Salafsky, N., Salzer, N., Stattersfield, A.J., Hilton-Taylor, C., Neugarten, R., Butchart, S.H.M., Collen, B., Cox, N., Master, L.L., O'Connor, S., & Wilkie, D. (2008). A standard lexicon for biodiversity conservation: unified classifications of threats and actions. *Conservation Biology*, 22, 897-911.
- Scott, J.M., Abbit, R., & Groves, C. (2001). What are we protecting? *Conservation Biology in Practice*, 2 (1), 18–19.
- Schwartzman, S., Moreira, A., & Nepstad, D. (2000). Rethinking Tropical Forest Conservation: Perils in Parks. *Conservation Biology*, 14(5), 1351-1357.
- Sepúlveda, C., Moreira, A., & Villarroel, P. (1997). Conservación biológica fuera de las áreas silvestres protegidas. *Ambiente & Desarrollo*, 13(2), 48-58.
- Support Programs SAGARPA 2014 (Procampo). Available from: <http://www.sagarpa.gob.mx/ProgramasSAGARPA/Paginas/default.aspx> (accessed April 2014).
- The Ramsar Convention on Wetlands (Ramsar), Comisión Nacional de Áreas Nacionales Protegidas (CONANP), & Secretaría de Medio Ambiente y Recursos Naturales (SEMARNAT). (2013). Humedales de México, Humedales Mexicanos de Importancia Internacional (Sitios Ramsar). Available from: <http://ramsar.conanp.gob.mx/sitios.php> (accessed October 2013).

- Toledo, V.M., Carabias, J., Toledo, C., & González-Pacheco, C. (1989). La producción rural en México: alternativas ecológicas. México: Fundación Universo Veintiuno.
- Toledo, V.M. (2005). Repensar la conservación: ¿áreas naturales protegidas o estrategia bioregional? *Gaceta ecológica*, 77, 67-83.
- Torres-Torres, F., & Gasca-Zamora, J. (2001). *Ingreso y alimentación de la población en el siglo XX*. México: Universidad Nacional Autónoma de México, Instituto de Investigaciones Económicas & Miguel Ángel Porrúa.
- United Nations, (1992). *Convention on Biological Diversity*. Available from: <http://www.cbd.int/convention/> (accessed April 2014).
- Weston, M., Tzaros, C.L., & Antons, M. J. (2006). Awareness of wetlands and their conservation value among students at a primary school in Victoria, Australia. *Ecological Management and Restoration*, 7(3), 223-225.
- Yarwood, M.R., Weston, M.A., & Garnett, S.T. (2014). From little things, big things grow; trends and fads in 110 years of Australian ornithology. *Scientometrics*, 98, 2235-2254.
- Zedler, J.B. (2003). Wetlands at your service: reducing impacts of agriculture at the watershed scale. *Frontiers in Ecology & the environment*, 1, 65-72.

CHAPTER 3

HABITAT OCCUPATION BY WATERBIRDS AT A NON-COASTAL
WETLAND SYSTEM MODIFIED BY CHANNELIZATION AND LARGE-
SCALE AGRICULTURE: HABITAT TYPE VS. LANDSCAPE
COMPOSITION

Abstract

Habitat occupancy by three waterbird species including the Marsh Wren (*Cistothorus palustris*), the American Coot (*Fulica americana*), and the Killdeer (*Charadrius vociferus*) was studied in a highly disturbed wetland system at the high plateau of San Luis Potosí State, Mexico. The main goal of the study was to compare effects on habitat occupancy patterns by these species of 1) habitat type (agriculture vs. remnant aquatic habitat) at the local scale, 2) landscape composition (percent agriculture within 10 km of sampling sites) at the regional scale, and 3) a combination of both these factors. The study species were sampled during two periods; first from June to September 2012, and then from January to February 2013. Habitat occupancy models were developed to estimate the magnitude of effects influencing occupancy patterns. The results revealed variation in habitat occupancy among the three species studied. For the Marsh Wren, occupancy increased in the aquatic habitat, but not in agriculture, with percent agriculture in both seasons (rainy and dry). Occupancy by the American Coot at the rainy season increased with increasing percent agriculture both in agriculture and aquatic habitats. During the dry season, however, occupancy by this species only increased with increasing agriculture in the aquatic habitat. Finally, habitat occupancy by the Killdeer at the rainy season responded to the interaction of habitat type with landscape composition, and during the dry season occupancy by this species increased with percent agriculture but only in the aquatic habitat.

KEYWORDS habitat occupancy, landscape composition, detectability, Marsh Wren, American Coot, Killdeer, wetland degradation.

Resumen

Se estudió la ocupación del hábitat para tres especies de aves acuáticas, incluyendo el Cucarachero pantanero (*Cistothorus palustris*), la Gallareta americana (*Fulica americana*), y el Chorlo tildío (*Charadrius vociferus*), las cuales habitan un sistema de humedales altamente perturbado que se ubica en la meseta del estado mexicano de San Luis Potosí. El principal objetivo de este estudio fue evaluar los efectos sobre los patrones de ocupación de hábitat para estas especies a dos escalas espaciales, 1) a escala local en respuesta al tipo de hábitat (agricultura vs hábitat de agua remanente), 2) a escala regional en función de la composición del paisaje (porcentaje de agricultura dentro de 10 kilómetros en los sitios muestreados) y 3) evaluar posibles interacciones en la respuesta a ambos factores. Los muestreos se realizaron en dos periodos; el primero durante Junio-Septiembre de 2012 y, a continuación, durante Enero-Febrero de 2013. Posteriormente, se utilizaron modelos de ocupación de hábitat para estimar la magnitud de los efectos que influyen en la ocupación. La respuesta a los patrones de cambio de uso del suelo en ocupación del hábitat varió entre las tres especies estudiadas. Para el Cucarachero pantanero la ocupación incrementó en el hábitat acuático con el porcentaje de agricultura en ambas temporadas (lluvias y secas), pero no en el hábitat agrícola. Para la Gallareta americana en la temporada de lluvias, su ocupación aumentó con el porcentaje de agricultura en ambos hábitats, mientras que en la estación seca, sólo aumentó la ocupación en el hábitat acuático. En la temporada de lluvias, para el Chorlo tildío los efectos del cambio de hábitat en ocupación del hábitat mostraron interacciones entre la escala local y la de paisaje, con aumentos y disminuciones en la ocupación de hábitat en función del aumento de agricultura en los hábitats acuático y agrícola, respectivamente. Finalmente, en la estación seca, el porcentaje agrícola tuvo un efecto positivo únicamente en la ocupación del hábitat acuático, pero no en la agricultura.

PALABRAS CLAVE. ocupación de hábitat, composición del paisaje, detectabilidad, Cucarachero pantanero, Gallareta americana, Chorlo tildío, degradación de humedales.

Background of the Rioverde Valley

Wetland habitat modification through channelization and establishment of large intensive agricultural complexes may have profound effects on biota as a whole. The Everglades wetland system is a good example of these processes. This system is a tropical wetland extending from Lake Okeechobee southward to Florida Bay and the Gulf of Mexico. In this wetland, human modification of the natural flow began early in the 20th century, and involved levees, channels, pumping stations and water-control structures to drain large areas. These hydrological modifications had negative consequences for the biota; it has been estimated that reduction in total wading bird nesting population in the southern Everglades surpasses 90%. Other species including the Seaside Sparrow (*Ammodramus maritimus*), the Florida Grasshopper Sparrow (*Ammodramus savannarum floridanus*), the Kirtland's Warbler (*Setophaga kirtlandii*), the Wood Stork (*Mycteria americana*), the Red-cockaded Woodpecker (*Picoides borealis*), and the American alligator (*Alligator mississippiensis*) have also suffered similar declines (Ogden 1994; DeAngelis et al. 1998; Brown et al. 2006).

Severe modifications have also occurred in wetland systems located in semi-arid regions. The Rioverde Valley and the associated wetlands, located in Central San Luis Potosí State, Mexico is an example of this and the subject of the current study. In comparison to the Everglades, the Rioverde Valley is located at a region having dry semi desertic climate, and thus, consequences of habitat degradation could be more severe. Before agricultural modifications took place

beginning in the XVI century, a broad area of the Rioverde Valley was inundated by a large wetland that had originated during the quaternary period (Rzedowski 1965). Back then, a continuous spectrum of hydro periods which had important ecological implications, characterized this region. However its flow has declined over the centuries as a consequence of the development of irrigated agriculture. Changes in land and water use in this region initiated with the Conquest and Colonization by the guachiles indigenous in the Rioverde Valley in 1543, and continued with the establishment of the Franciscan mission in 1617. This mission promoted digging of the "Rioverde Ditch". As a result of channelization, orchards and fields (e.g. citrus crops) of the "Rioverde" village were extensively irrigated (Velázquez 1987). In 1731 another ditch, the "Villain Ditch" was constructed for irrigation of the lands around Ciudad Fernández (Verástegui 1979). In addition, the establishment of the Mexican estates originated the construction of new ditches and intensified the use of water and land. The "Estate of Jabalí", for instance opened 2 new ditches ("El Capulín" and "Potrero de Palos") to irrigate crops for the cultivation of sugarcane, corn, chili, beans, and chickpeas. In the decade of the 40's, the ejidos located south and southeast of the Rioverde Valley obtained rights to build a fifth ditch known as "San José Ditch". Finally, in 1980 the Irrigation District 049 was established; the ditches "Rioverde and Villain" gathered in a single channel, known as the main channel and a network of secondary channels was built, and agricultural and urban land uses quickly substituted wetlands. At present, the municipalities of Rioverde and Ciudad Fernández are part of the agricultural region of Rioverde, which is one of the most important for the State of San Luis

Potosí. Nowadays land tenure in the valley of Rioverde consists mostly of ejidos and smallholders (Charcas et al. 2000).

Various species of animals from different taxa (e.g. crustaceans, plankton, and small endemic fish) have historically inhabited this wetland system. Their distribution and abundance, however, has been reduced as a consequence of modifications of the natural hydrology, and disruption of trophic dynamics through establishment of an agriculture-dominated landscape (Palacio-Núñez et al. 2007). The same likely happened to aquatic birds: their populations likely decreased due to the reduction and deterioration of their natural habitats. In human dominated landscapes, species with restricted distribution, and those having specificity in their habitat requirements may become highly vulnerable.

Introduction

Worldwide, land cover is being lost to productive human activities such as agriculture, rising of livestock, forest harvesting, settlements, industrial park construction, and mining, among others (Meyer 1995; Dale et al. 2000). In recent centuries, two trends have been evident; the total area for human uses has grown rapidly, and the demand for goods and services has increased both use and control of the land (Richards 1990). Land cover alteration, is faster at regions with rapid population growth. Land-use activities rapidly change landscape structure by altering the relative cover of natural habitats and introducing new land-cover types. Often, this process modifies the configuration of the natural landscape and alters the functioning of ecosystems, thus simplifying the landscapes in terms of the biodiversity that they contain (DeFries et al. 2004). Many landscapes that originally were diverse and highly structured in terms of biodiversity have been converted into much more uniform areas consisting of productive units (Stoate et al. 1991; Robinson & Sutherland 2002). The introduction of new cover types can also modify biodiversity attributes by providing unique habitats for some opportunistic species. Through this process, however, natural habitats are often reduced, leaving less area of available habitat for native flora and fauna. The changes in land uses associated with productive human activities have promoted the creation of homogeneous landscapes consisting of a mosaic of environments or "patches" with different covers and land uses where human-originated environments are the dominant land use types. The resulting landscapes are characterized by remnant

vegetation fragments embedded in a matrix of secondary vegetation, open areas for agricultural uses and human settlement areas (Rivera-Rivera et al. 2012). These landscapes vary in composition (variety, number, and amount of environments) and configuration (spatial arrangement) (Farina 2000). Therefore, the patterns of occupancy (proportion of sites occupied), abundance, and distribution of wildlife (Mackenzie & Royle 2005) is quite different in comparison to original landscapes. Consequently, the importance and magnitude of these changes needs to be evaluated.

Aquatic ecosystems are usually sites of intensive human activity and have been much transformed and degraded. The prevailing trend is the replacement of natural wetland landscapes by agricultural fields, livestock land, and urban areas. The Mexican territory contains numerous non-coastal wetlands which provide habitat for a highly diverse associated biota. Compromising the environmental services that these systems provide (Antrop 2005) may have serious environmental consequences. Human activities alter landscape patterning and often have substantial effects on flora and fauna at different levels of organization such as populations and communities. Non-coastal wetlands are very important for aquatic bird species that perform their vital activities as searching for shelter, nesting, feeding, resting, and/or roosting (Mafabi 2000). During the development of agriculture and livestock activities, a small set of species may adapt to these widespread forms of land use changes that surround the Mexican non-coastal wetlands; these are the cases of some generalist waterfowl species. Other aquatic bird species, however, are likely to be harmed by such disturbances. Such is the case of sensitive species, which have specific habitat requirements and limited

adaptive capacity. Therefore, management of wetland systems in the 21st century is likely to play a critical role in determining the fate of many aquatic systems and the associated biota (Tockner & Stanford 2002).

Justification

Wildlife populations must contend with increasingly human-modified landscapes. Patterns of composition and structure of these landscapes determine the connectivity and suitability of native habitats that in turn, influences patch occupancy, abundance and persistence of species in these habitats (Gibbons et al. 2000; Fahrig 2007). Environmental characteristics of both the local habitat patch and the surrounding landscape context can be important determinants in the habitat occupancy and abundance patterns of species (Pearson 1993; Wiens 1997; Thomas et al. 2001). The relative response in habitat occupancy and abundance patterns to patch versus landscape characteristics varies among taxa (Collinge 2009). It is, therefore, necessary to conduct studies to identify the local and landscape factors that influence occurrence and abundance of individual species, as well as the effects of anthropogenic land use on these processes.

Aquatic birds are indicators of overall biodiversity and biotic integrity. They are susceptible to a variety of natural and anthropogenic perturbations (Welsh & Droege 2001). Bird surveys have been conducted for several purposes, including 1) to establish baseline data and techniques for long-term monitoring programs (Gibbons et al. 1997; Corn 2000; Dodd et al. 2000; Hyde & Simons 2001), 2) to compare historical to current species distributions (Fisher & Shaffer 1996; Shaffer et al. 1998; Corser 2001), and 3) to identify priority issues of bird diversity and

abundance. State variables such as detection probability and habitat occupancy can be compared over time or space to make inferences about temporal changes in population status, or the effects of environmental or anthropogenic factors (Petranka et al. 1993; Skelly et al. 1999; Pilliod & Peterson 2001). Through the study of these variables, inferences can be made about site-specific habitat characteristics that influence the size of the available population (Bailey 2003), and management strategies can be designed.

The aim of the current study was estimating occupancy and species detection probabilities for three aquatic bird species that occur in a wetland system located at the high plateau of the State of San Luis Potosí. This system has been severely modified by channelization and by establishment of large-scale agricultural complexes. Some large areas within the region, however, have received relatively moderate disturbance. Therefore, this system is ideal for simultaneously investigating the effects of large-scale habitat transformation and habitat type on aquatic bird populations, and the results should be applicable to similar wetland systems in semi-arid regions. This study is the result of the analysis of habitat occupancy patterns and detection probabilities of three aquatic species at two landscape scales: at the *local scale* the effect of natural (aquatic) vs. anthropogenic (agricultural) habitat was investigated, and at *regional scale* the effect of landscape composition in terms of proportion of anthropogenic and natural habitat within the landscape was studied. Habitat alteration at these two scales may influence the main parameter of interest, occupancy (Ψ) (Hyde & Simons 2001; Bailey 2003).

The main objective was to evaluate the effect of habitat transformation by channelization and the establishment of large-scale agriculture on habitat occupancy patterns by three species of birds associated to aquatic environments. Specific objectives included simultaneously assessing the effect of habitat type (water vs. agriculture) at the local scale, and landscape composition (% of agriculture within 10 km) at the landscape scale, and also to identify possible interactions of the effects operating at these two scales.

For the current study, three different aquatic bird species with increasing degrees of sensibility were chosen, this allowed generating conclusions that may be applicable to a wide range of aquatic bird species depending on their sensibility to habitat modification.

Marsh Wren (*Cistothorus palustris*), the first study species is the most sensitive to habitat degradation. It is sensitive to human disturbance and feeds exclusively from water-dwelling insects (Kroodsma & Verner 1997). Therefore, it was hypothesized that occupancy by this species would be higher in well-preserved aquatic habitats in comparison with agricultural habitats. In fact, it was expected that this species would be absent from agricultural habitats.

The American Coot (*Fulica americana*) is intermediate in terms of vulnerability to aquatic habitat degradation. This species inhabits a wide variety of freshwater wetlands including swamps, marshes, suburban parks and sewage ponds. It feeds from a wide variety of sources including aquatic plants, crustaceans, snails, and small vertebrates, but it is also a granivore that feeds from grains of oaks, elms, and cypress trees, and an insectivore that may consume beetles and dragonflies (Brisbin et al 2002). Though this species shows higher

tolerance to habitat degradation, it is still a wetland habitat obligate. Therefore for this species it was hypothesized that its occupancy would be large in both, water and agricultural areas when these would be flooded, but absent from dry agricultural fields, and that increasing proportion of agriculture within the landscape would have neutral effects on the dynamics of occupancy by this species, especially because it is sensitive to some extent, but it may benefit from agriculture as this habitat may provide some food resources.

Finally, for the Killdeer, it was hypothesized that its occupancy would be similar in both habitats (water and agricultural), because this species usually is present in open areas, as grazed fields, and also because it is an opportunistic forager whose diet is based on invertebrates and seeds left in agricultural lands (Howell & Webb 1995; Jackson & Jackson 2000).

Methods

Study region

The current study was conducted at several wetlands including three springs; Media Luna, Los Peroles, and Charco Azul located at the Rioverde Plain geomorphological region, and two lagoons; San Ciro de las Albercas at the Southern highlands region, and Los Coyotes at the Rioverde Plain geomorphological region. All the wetlands included in this study belong to the Panuco basin. The weather in the region is semiarid-semicalid (BS1hw(w) (e) gw") (García 1988) with an average annual temperature of 21°C, and annual rainfall fluctuating between 497 mm and 789 mm. Average altitude in the region is 990 m.a.s.l. The springs included in the study are part of a larger regional system of karstic springs (vertical wells). Media Luna is the most abundant and bigger spring in the region (Charcas et al. 2002) and has an annual water flux of 4.7 L/s. Los Peroles has a water flux of 500-800 L/s, Charco Azul has a flow rate of 0.189 L/s, and San Ciro de las Albercas and Los Coyotes are lagoons that receive most of their water input from intermittent streams (Aguilar 2010). According to SEGAM (2004) the main plant association in the hills of this region is microphilous scrubland that sometimes associates with *Opuntia* scrublands. In the plains, microphilous scrublands, halophyte vegetation, herbazal, and pastures are present, as well as mezquite scrublands in undisturbed areas. There are also communities whose distribution is conditioned by the presence of water, such as riparian vegetation with sables (*Taxodium* spp.), willow (*Salix* sp.), reeds

(*Phragmites* sp.) and tule (*Typha* sp.). These associations are located in the shores of the lagoons and in the margins of some channels. Due to the isolation of these springs, they present several fish endemisms and provide refuge for the migratory and resident fauna, including birds (Palacio-Núñez, et al. 2010). The main productive activity is agriculture, and the most common crops are corn, tomatoes, sorghum, alfalfa, orange, beans and pumpkins (Mendoza 1944; Alemán 1966), and agrochemicals are extensively used. Livestock is also present to a lesser extent. Some springs in the region are used for recreational purposes. These activities, especially agriculture have been so extensive that the landscape has been transformed profoundly over the years (SEGAM 2004; CONABIO 2009). The effects of these changes on associated fauna, however, have not been assessed for all taxonomic groups.

Fieldwork

Six bird surveys were conducted in the study region, the Rioverde valley. Within this region, five wetlands (La Media Luna, Los Coyotes, Los Peroles, Charco azul, and San Ciro de las Albercas) were surveyed from August 2011 to January 2013. For the entire study 120 permanent census points were established for bird surveys using variable radius point counts. For this chapter, the data from two field seasons corresponding to June-September 2012 and January-February 2013 were analyzed. Each field season had an approximate duration of 24 days. Bird surveys were conducted from 6:30 until 11:00 in the morning. During surveys each count point was sampled for a period of 10 minutes. During this time, all observations of the focal species were recorded. All surveys were performed by two observers. In

order to guarantee independence, point counts were located at a minimum distance of 300 m from each other. Surveys were conducted under appropriate weather conditions defined as days with moderate cloud cover, without rain and without strong winds. For this study, two habitat types were surveyed; 1) aquatic which included bodies of water (springs and lagoons), and their associated floodplains, and 2) agricultural fields.

In order to estimate detection probabilities (P_i), individual count points were grouped in six independent points that acted as replicates of each count in each surveying occasion. These replicates were count points located at a large enough distance to guarantee independence (see above), but close enough to count as a replicates for the same site (Mackenzie et al. 2002).

Although a large number of species were recorded, the current study focused on three species, two of which are obligate to aquatic habitats (*Cistothorus palustris* and *Fulica americana*), and one that also associates to aquatic habitats but is not an obligate (*Charadrius vociferus*).

Landscape composition

For each count point, habitat type (aquatic vs. agriculture, see above) at the local scale (i.e., within a 300-m radius) was recorded. In order to quantify landscape composition at the landscape scale (i.e. within 10 km of each point), a digital land use land cover map from the study area (Chapa-Vargas & Monzalvo-Santos 2012) was used to identify habitat type. Using a Geographic information system (ArcView 3.3, Environmental Systems Research Institute 2002) a point located at the center of all six replicate count points for estimation of detectability (see above) was

digitized. Around each of these points, a buffer with a radius of 10 km was built, and within each of these buffers percent agriculture cover was measured.

Statistical analysis

Proportion of area occupied (PAO) estimation:

Following the Mackenzie et al. (2002) likelihood-based method, the proportion of area (or sites) occupied when species detection probabilities are less than 1 was estimated. This method uses replicate surveys (the six replicate count points for the current study, see above) to estimate detection probabilities, and represents an extension of traditional closed-population capture-recapture theory in which all estimation models assume that 1) the population of the focal species is closed to occupancy during the study, 2) species are correctly identified, and 3) the probability of detecting a species at one site is independent of probability of detecting the species at all other sites (MacKenzie et al. 2002). The dependent variable assumes a value of "0" if the species was not detected on a visit to the sampling station, and "1" every time it was detected on a single visit (Robbins et al. 1989). Single-species, single-season occupancy models with site covariates (MacKenzie et al. 2002) were used for each species-season combination to assess occupancy trends of the three bird species analyzed in response to habitat type and landscape composition. Species were analyzed separately, thus specific detection probabilities could be estimated.

Statistical modelling

Data from the study sites were used to estimate two parameters of interest; occupancy, $\Psi(\cdot)$ and detection probability $P_i(\cdot)$ of the three aquatic bird species under study. The software *PRESENCE* Ver.4.5 (Hines 2006) was used to estimate $\Psi(\cdot)$ and five candidate models explaining variation in the parameters of interest were compared using the *Akaike information criterion* (AIC, Burnham & Anderson 2002). This method allowed analyzing ecological data using a set of *a priori* models and selecting the model that was most efficient in terms of parsimony and explanatory power. The most parsimonious model is the one with the lowest value and that best fits the data using as few parameters as possible (Burnham & Anderson 2002). For the three species, the small samples size version of the Akaike Information Criterion (AIC_c) (Burnham & Anderson 2002) was used to select among models explaining variation in habitat occupancy. Thus, a set of five different *a priori* hypotheses was established. These hypotheses were models of variation in habitat occupancy as a function of different combinations of explanatory variables including effects of *habitat type*, *landscape composition*, *a combination of habitat type plus landscape composition*, and *the interaction between landscape composition and habitat type*. Therefore, the models were as follows: 1) the *null model* $\Psi(\cdot)$, $P_i(\cdot)$ which considers no explanatory variables, 2) effects of *habitat type* $\Psi(\text{Hab})$, $P_i(\cdot)$, this model included agriculture and aquatic as the habitat types, 3) *composition of landscape* $\Psi(\%Ag)$, $P_i(\cdot)$ which included percentage of agriculture within 10 km of count points, 4) a model including additive effects of *habitat type and landscape composition* $\Psi(\text{Hab}+\%Agr)$, $P_i(\cdot)$,

and 5) the *Global model* Ψ (Hab+%Ag+(Hab*%Ag)), $\Pi(\cdot)$ which considered additive and interaction terms between landscape composition and habitat type. This last model was used to evaluate model fit using the Mackenzie and Bailey (2004) goodness-of-fit test. The Akaike's information criterion (Burnham & Anderson 2002) was used to rank models from most to least supported given the data on the basis of Akaike differences (ΔAIC_c = the difference in AIC_c between the model with the smallest AIC_c value and the current model) and Akaike weights (w_i). Each w_i is a measure of support for each model based on ΔAIC that adds to 1 across all models. These values provide direct interpretation of the relative likelihood of a model given the data and the set of candidate models; a given w_i is considered as the weight of evidence in favor of its corresponding model. Because all censuses were conducted under similar environmental conditions, detection probabilities were assumed as constant among surveys; therefore, the Π parameter was kept constant for all models. Finally, in order to account for model uncertainty, weighted parameter estimates were averaged across all models using Akaike weights (w_i) as weights (e.g., Burnham and Anderson 2002), and these parameters were used to depict estimated occupancy against the independent variables. Because this is the first study evaluating habitat occupancy patterns by aquatic birds in the high plateau of Mexico, multi-model inference was conducted for both independent variables even in cases when either or both of these variables were absent from the models receiving equivalent support in comparison with the best-supported model.

Results

In all, 4099 records from 158 species were obtained. For both the 2012 rainy season and the 2013 dry season, the global model for the Marsh Wren (*Cistothorus palustris*) fit the data well (MacKenzie and Bailey goodness-of-fit test, $X^2=39.24$ and 97.62 , $P=0.386$, and 0.436 respectively). Detection probability estimates were 0.082 and 0.398 for the 2012 and 2013 seasons respectively. For both the 2012 rainy season and 2013 dry season the best model explaining variation in habitat occupancy for this species included habitat type as the only explanatory variable, $\Psi(\text{Hab})$, $\text{Pi}(\cdot)$. In addition, for both seasons the model including additive effects of habitat type and landscape composition effects received support from the data equivalent to the best supported model ($\Delta\text{AIC}<2.0$, Tables 3.1 and 3.2). Based on model-averaged parameter estimates, in both seasons occupancy by this species was greater in water habitats in comparison with the agricultural habitat. Within water habitats, occupancy increased, but only very slightly, with increasing percentages of agriculture within 10 km (Figs. 3.1 and 3.2).

Figure 3.1. Estimated habitat occupancy by *Cistothorus palustris* during the 2012 rainy season.

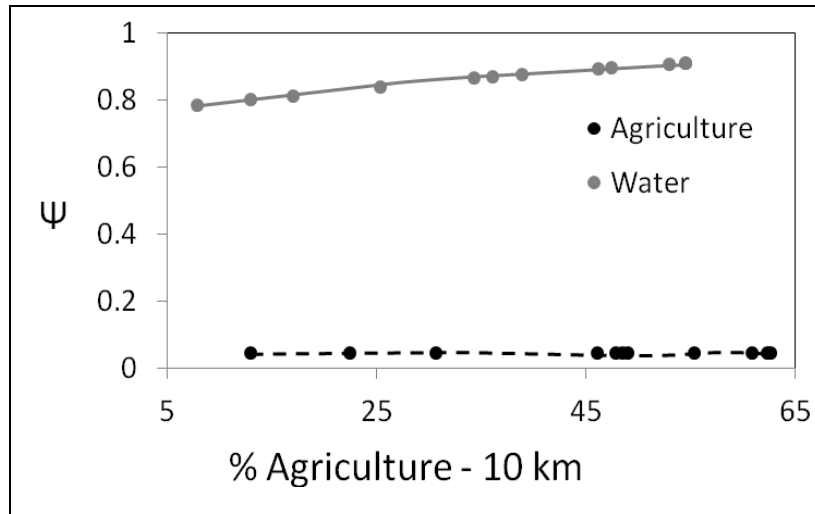

Table 3.1. Model selection criteria for five models explaining habitat occupancy (Ψ) by *C. palustris* during the rainy season in response to habitat type (Hab), percentage of agriculture within 10,000 m (%Agri), and interactions of these two variables. AIC= Akaike information criterion, Δ AIC = scaled value of AIC, AIC w_i = Akaike weights, and P_i = detectability.

Model	AIC	Δ AIC	AIC w_i
$\Psi(\text{Hab}), P_i(.)$	40.59	0	0.5764
$\Psi(\text{Hab}+\% \text{Agri}), P_i(.)$	42.3	1.71	0.2451
$\Psi(\text{Hab}+\% \text{Agri}+\text{Hab}*\% \text{Agri}), P_i(.)$	44.3	3.71	0.0902
$\Psi(.), P_i(.)$	44.97	4.38	0.0645
$\Psi(\% \text{Agri}), P_i(.)$	46.97	6.38	0.0237

Figure 3.2. Estimated habitat occupancy by *Cistothorus palustris* during the 2013 dry season.

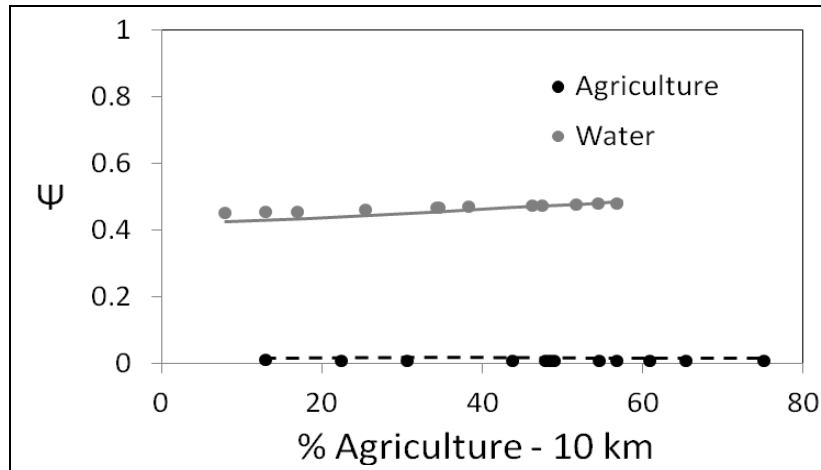

Table 3.2. Model selection criteria for five models explaining habitat occupancy (Ψ) by *C. palustris* during the dry season in response to habitat type (Hab), percentage of agriculture within 10,000 m (%Agri), and interactions of these two variables. AIC= Akaike information criterion, Δ AIC= scaled value of AIC, AIC wi= Akaike weights, and Pi= detectability.

Model	AIC	Δ AIC	AIC wi
$\Psi(\text{Hab}), \text{Pi}(\cdot)$	62.15	0	0.6345
$\Psi(\text{Hab}+\% \text{Agric}), \text{Pi}(\cdot)$	64.1	1.95	0.2393
$\Psi(\text{Hab}+\% \text{Agric} + \text{Hab} * \% \text{Agric}), \text{Pi}(\cdot)$	66.1	3.95	0.088
$\Psi(\cdot), \text{Pi}(\cdot)$	68.54	6.39	0.026
$\Psi(\% \text{Agric}), \text{Pi}(\cdot)$	70.06	7.91	0.0122

For the 2012 rainy season, the global model for the American Coot (*Fulica americana*) fit the data well (MacKenzie and Bailey goodness-of-fit test, $X^2=33.05$

and $P=0.722$). Detection probability was estimated at 0.0746. The best model explaining variation in habitat occupancy for this species in this season included composition of the landscape as the explanatory variable, $\Psi(\%Agriculture)$, $Pi(.)$. No additional models received support from the data equivalent to the best supported model (Table 3.3). Based on model-averaged parameter estimates, during this season, occupancy by this species increased asymptotically with increasing percentage of agriculture within 10 km independently of habitat type (Fig. 3.3).

Figure 3.3. Estimated habitat occupancy by *Fulica americana* during the 2012 rainy season.

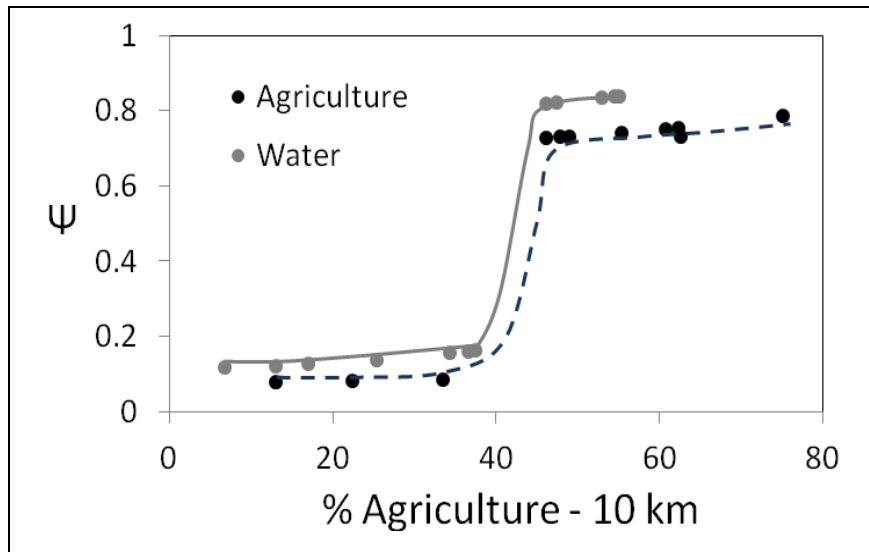

Table 3.3. Model selection criteria for five models explaining habitat occupancy (Ψ) by *F. americana* during the rainy season in response to habitat type (Hab), percentage of agriculture within 10,000 m (%Agri), and interactions of these two variables. AIC= Akaike information criterion, Δ AIC= scaled value of AIC, AIC w_i = Akaike weights, and P_i = detectability.

Model	AIC	ΔAIC	AIC w_i
$\Psi(\%Agric), P_i(.)$	41.57	0	0.6338
$\Psi(.), P_i(.)$	44.49	2.92	0.1472
$\Psi(Hab+\%Agric), P_i(.)$	45.37	3.8	0.0948
$\Psi(Hab), P_i(.)$	45.49	3.92	0.0893
$\Psi(Hab+\%Agric+Hab*\%Agric),$	47.37	5.8	0.0349

For the 2013 dry season, the global model for the American Coot fit the data well (MacKenzie and Bailey goodness-of-fit test, $X^2= 64.7796$ and $P=0.356$), and detection probability was estimated at 0.2890. The best model explaining variation in habitat occupancy for this species in this season included composition of landscape as the explanatory variable, $\Psi(Hab+\%Agric), P_i(.)$. In addition, for this season the model including additive effects and the interaction of habitat type and landscape composition received support from the data equivalent to the best supported model (Δ AIC<2.0, Table 3.4). Based on model-averaged parameter estimates, in this season, occupancy of this species was greater in water habitats in comparison with the agricultural habitat, and within water habitats, occupancy increased exponentially, with increasing percentages of agriculture within 10 km (Fig. 3.4.).

Figure 3.4. Estimated habitat occupancy by *Fulica americana* during the 2013 dry season.

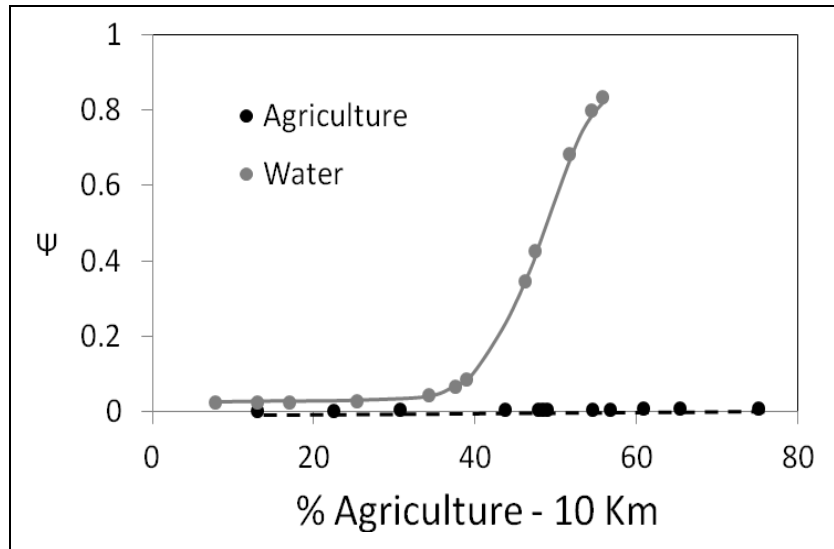

Table 3.4. Model selection criteria for five models explaining habitat occupancy (Ψ) by *F. americana* during the dry season in response to habitat type (Hab), percentage of agriculture within 10,000 m (%Agri), and interactions of these two variables. AIC= Akaike information criterion, Δ AIC= scaled value of AIC, AIC w_i = Akaike weights, and P_i = detectability.

Model	AIC	Δ AIC	AIC w_i
$\Psi(\text{Hab}+\%\text{Agric}), P_i(.)$	32.94	0	0.655
$\Psi(\text{Hab}+\%\text{Agric}+\text{Hab}*\%\text{Agric}), P_i(.)$	34.94	2	0.241
$\Psi(\text{Hab}), P_i(.)$	37.43	4.49	0.0694
$\Psi(.), P_i(.)$	39.91	6.97	0.0201
$\Psi(\%\text{Agric}), P_i(.)$	40.56	7.62	0.0145

For the 2012 rainy season, the global model for the Killdeer (*Charadrius vociferous*) fit the data well (MacKenzie and Bailey goodness-of-fit test, $X^2=37.20$, $P= 0.802$). The detection probability estimate was 0.1429. For this season the null model, $\Psi(\cdot),\Pi(\cdot)$, was the one that best explained variation in habitat occupancy for this species, and no additional models received support from the data equivalent to the best supported model (Table 3.5). Based on model-averaged parameter estimates, in this season estimated occupancy by this species increased exponentially with increasing percentage of agriculture within the 10 km radius for water habitats, and decreased exponentially with increasing agriculture within the same distance for the agriculture habitat (Fig. 3.5).

Figure 3.5. Estimated habitat occupancy by *Charadrius vociferus* during the 2012 rainy season.

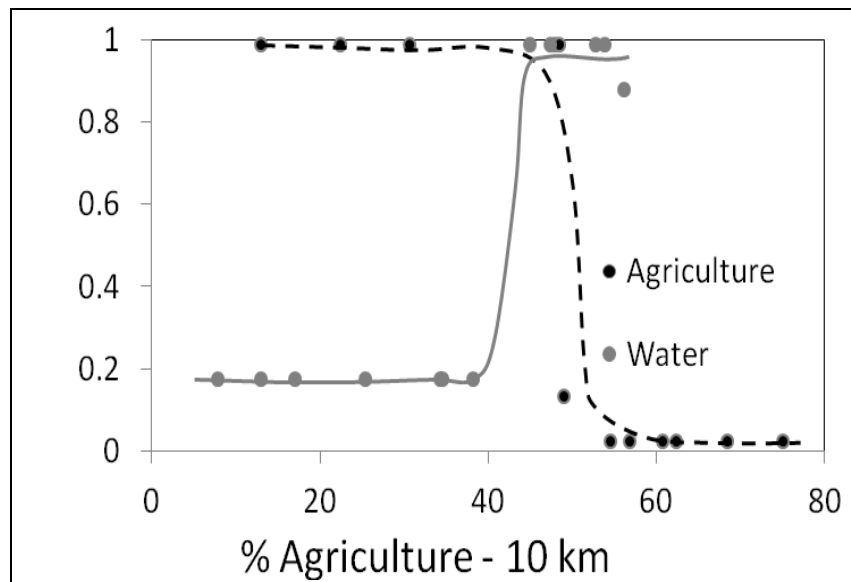

Table 3.5. Model selection criteria for five models explaining habitat occupancy (Ψ) by *Ch. vociferus* during the rainy season in response to habitat type (Hab), percentage of agriculture within 10,000 m (%Agri), and interactions of these two variables. AIC= Akaike information criterion, Δ AIC= scaled value of AIC, AIC w_i = Akaike weights, and P_i = detectability.

Model	AIC	ΔAIC	AIC w_i
$\Psi(\cdot), P_i(\cdot)$	50.19	0	0.8134
$\Psi(\%Agri), P_i(\cdot)$	54.19	4	0.1101
$\Psi(Hab+\%Agri), P_i(\cdot)$	56.19	6	0.0405
$\Psi(\cdot), P_i(\cdot)$	57.05	6.86	0.0263
$\Psi(Hab), P_i(\cdot)$	59.05	8.86	0.0097

Finally, for the same species at the 2013 dry season, the global model fit the data well (MacKenzie and Bailey goodness-of-fit test, $X^2= 70.54$ and $P=0.73$). Detection probability estimate was 0.3330. For this season the best model explaining variation in habitat occupancy for this species included habitat type as the explanatory variable, $\Psi(Hab), P_i(\cdot)$. In addition, the model including additive effects of habitat type and landscape composition effects received support from the data equivalent to the best supported model (Δ AIC<2.0, Table 3.6). Based on model-averaged parameter estimates, in this season, occupancy by this species was greater in water habitats in comparison with the agricultural habitat. In addition, within the water habitat, occupancy increased with increasing percentages of agriculture within 10 km (Figure. 3.6).

Figure 3.6. Estimated habitat occupancy by *Charadrius vociferus* during the 2013 dry season.

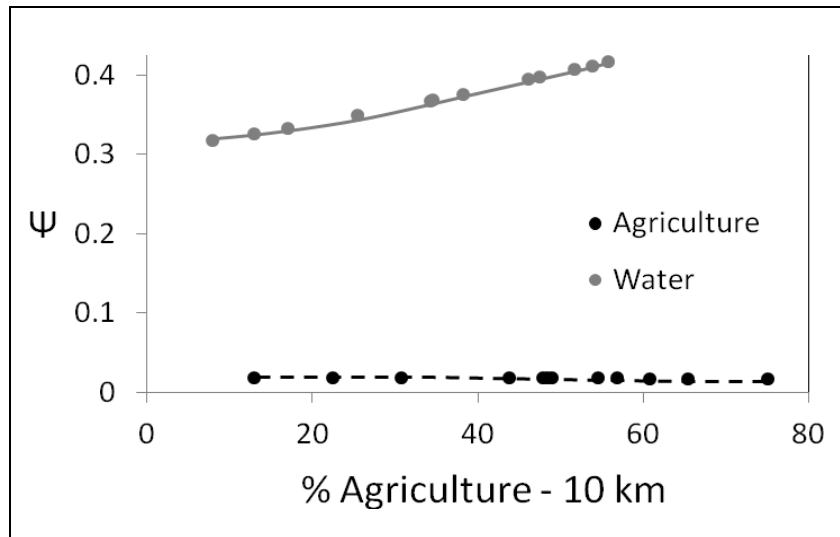

Table.3.6. Model selection criteria for five models explaining habitat occupancy (Ψ) by *Ch. vociferus* during the dry season in response to habitat type (Hab), percentage of agriculture within 10,000 m (%Agri), and interactions of these two variables. AIC= Akaike information criterion, Δ AIC= scaled value of AIC, AIC w_i = Akaike weights, and P_i = detectability.

Model	AIC	Δ AIC	AIC w_i
$\Psi(\text{Hab}), P_i(.)$	48.11	0	0.5604
$\Psi(\text{Hab}+\% \text{Ag}), P_i(.)$	49.69	1.58	0.2543
$\Psi(\text{Hab}+\% \text{Ag}+(\text{Hab} * \% \text{Ag}), P_i(.)$	51.69	3.58	0.0936
$\Psi(.), P_i(.)$	52.37	4.26	0.0666
$\Psi(\% \text{Ag}), P_i(.)$	54.32	6.21	0.0251

Discussion

Of the species studied, *Cistothorus palustris* is the most vulnerable. According to the results, it showed similar trends in both seasons studied. For this species the presence of aquatic and semi-aquatic habitats is essential. Thus, the local scale is very important. The regional context may be of moderate influence as indicated by the increase in occupancy with increasing proportion of agriculture at the landscape scale. This increase was at the most slight. Within crops, there are different kinds of invertebrates (Swift & Anderson 1994; Wilson et al. 1999), and this species may benefit to some extent from surrounding agricultural areas. This species feeds from insects and spiders, and from gleaning insects from plants and from just below the water surface (Kroodsma & Verner 1997). Therefore, both scales are relevant for the species, although in this case, the influence of the local scale is stronger. The local level directly affects the occupational dynamics of the species, while landscape composition may indirectly influence this species by affecting food resources. In fact, it has been previously suggested that insect abundance may be greater in local aquatic habitats surrounded by an agricultural matrix (Fisher & Lindenmayer 2007). Unfortunately insect abundance was not measured in this study.

In the case of *Fulica americana*, this species inhabits a wide variety of freshwater wetlands (Ehrlich et al. 1988; Brisbin et al. 2002; Dunne 2006), and has the most diversified diet of the three species analyzed. This species not only feeds from plants (e.g. algae, duckweed, cattails, water lilies, etc.), but also consumes

grains or leaves from oak and cypress trees, small invertebrates (insects, snails and crustaceans), and small vertebrates (toads and salamanders). Having a wider diet could guarantee its long-term viability and thus occupancy for populations of this species. This means that the American Coot is easily adaptable to seasonal changes in food resources. In the rainy season, the occupancy by this species increased rapidly after the percentage of agriculture surpassed 35% in both aquatic and agricultural habitats. Therefore, the local and landscape scales are important during this season for this species. It is important, however, to stress that there must be water, because this species is obligate to this type of environment. In spite of the presence of permanent springs in the study area, rain is a critical process for this species as it originates temporary ponds that can hold small groups of coots, and also the rains flood many agricultural fields in the study area at "Los Coyotes", and "San Ciro de las Albercas", where this species was recorded, thus increasing the amount of available habitat. For this species, agriculture at the landscape level has a positive influence as it may increase food abundance (Benton et al. 2003; Tozer et al. 2010). During the dry season, however, occupancy by this species increased after the percentage of agriculture at the landscape scale surpassed 35%, but only in the aquatic habitat. Contrastingly, the agricultural habitat in this season, which was dry, was unoccupied independently of the percentage of agriculture within the landscape. Therefore, in this season, the agricultural habitat is not a suitable habitat, since there must be at least some small water bodies to ensure occupancy. Then, it can be concluded that large-scale substitution of wetlands by agriculture decreases the amount of available habitat for this species for the dry season. In summary, agriculture in this season provides food, but water

secures occupation. Because this species nests in aquatic vegetation, the aquatic habitat also is mandatory for the reproduction of this species.

Among the study species, the Killdeer, *Charadrius vociferus*, is the only non-obligate aquatic species. Despite being associated to coastal areas, it also uses both near water and dry areas. In the rainy season, increase in occupancy of the aquatic habitat by this species occurred after percent agricultural cover surpassed 40%. Contrastingly, in agricultural habitats, occupancy by this species decreased after agricultural cover at the landscape scale surpassed 40%. Agriculture is beneficial for this species to some extent, presumably due to its opportunistic nature and generalized diet based on insects, insect larvae, grains, worms, frogs and small fish (Ehrlich et al. 1988; Jackson & Jackson 2000). On the other hand, this species actually needs the presence of dry areas, as the nesting placement is on the ground (Dunne 2006). During the dry season, the Killdeer responds to patterns at both the local and the landscape scales. This is because local and landscape patterns are important for the provisioning of food, and shelter. In summary, the Killdeer is the species that most benefits from agriculture, but even this species may be negatively influenced by too much agriculture at the landscape scale.

Simultaneous management for species with different requirements in man-dominated landscapes must carefully consider all aspects of their biology. Therefore, habitats, behavior, nesting sites, feeding habits, and vulnerability should be provided in order to guarantee long-term viability. For the species included in the current study, their simultaneous needs translate into landscapes containing both water bodies which provide habitat, and food for *Fulica americana*, and

Charadrius vociferus, as well as dry areas for *Charadrius vociferus*. These landscapes could also include some agricultural crops that may promote food availability and nesting sites. However, large-scale agriculture exceeding 40% cover at the landscape scale may harm even some species that adapt well to this habitat at the local scale. Aside from these results, it is still to be seen to what extent agriculture influences some species that do not seem to adapt well to human-dominated environments such as some rallids including *Gallinago gallinago*, *Rallus limicola*, *R. elegans*. Also *Aythya collaris*, *A. affinis*, *Grus americana*, and *Larus delawarensis*. In fact, for these species, a very limited number of records were obtained during the course of the current study (6, 8, 4, and 3 respectively, and only one record for each of the last three species). These records were gathered only in aquatic habitats surrounded by landscapes with very low proportions of agriculture.

In the country, there aren't research studies related to the biology of the species studied. *Fulica americana* has been the subject of two studies, one in 1825, and one in 1992, but these investigations did not address ecological or population aspects (Rodríguez-Yáñez et al. 1994). In the cases of the other two species, the available information consists of reports of censuses in different regions of the country, or estimates of population and community parameters. Besides occupancy, future studies should investigate how habitat alteration at different scales may influence demographic aspects of the populations, as well as patterns of competition and predation, and community structure.

Conclusions

Certain human activities oriented to specific habitats can affect the distribution, and occupancy patterns of certain species. In places that serve as refuges that also provide food for abundant populations, proper management should consider the conservation of pristine areas for the persistence of the most vulnerable species. In the case of opportunistic species having greater plasticity in their use of resources, habitat alteration may also have negative effects, but the degree of harm for these species depends on the extent of habitat alteration. The results of the current study indicate that during the dry season, factors limiting aquatic bird populations may be more pronounced, some of these factors could possibly include competition, niche and food availability, depredation, mortality, etc., but to be more conclusive, studies specifically focusing on these aspects are needed. This result also implies that during drought years populations may be subject to greater ecological stress.

The results of this study demonstrate that ecological processes acting at spatial scales larger than the local environment have stronger impact in comparison with processes acting at local scales, at least for the species that were studied, and most likely for most other aquatic species. Moreover, interactions among processes operating at different spatial scales may be important determinants of some aspects of populations, as demonstrated in this study, and analyses that only consider one scale of analysis may fail at completely

understanding ecological processes. In addition, the temporal dimension may be important.

The species included in this study have different responses to local and regional scales. Season of the year (rainy vs. dry) and the biology of each species are both important. *Cistothorus palustris* is the most sensitive species studied. The local scale has the greatest influence for this species. For *Fulica americana*, which has a wide diet and that is capable of inhabiting different kinds of wetlands, local and landscape scale patterns are also of significance; the presence of water at local scale, and the landscape composition, in which the agricultural crops may provide different types of food resources are both important, but at the temporal scale, the dry season is the most limiting. And finally, for *Charadrius vociferus* which is the only non-obligate aquatic species, and opportunistic in nature, and a species of a generalized diet, agriculture has a positive effect, but only to some extent.

The vast majority of decisions on the use of resources have been directed toward the effects at local scales. However, this is inappropriate for the conservation of waterbirds. Also there must be management plans focusing at large scales. In addition, it must be taken into account that changes in total abundance of waterbirds result from changes in the frequency and/or extent of flooding which influences breeding opportunities and other aspects of organismal biology. The effects of water extraction, water storage, sedimentation, and/or climate change on the distribution of refuges during dry seasons may be severe, and thus, management should be planned carefully.

References

- Aguilar, F. (2010). Modelación prospectiva de la demanda de agua para uso agrícola y urbano en los municipios de Rioverde y Ciudad Fernández, San Luis Potosí, México. Posgrado multidisciplinario para ciencias ambientales (PMPCA, UASLP).
- Alemán, E. (1966). *Investigación socioeconómica directa de los ejidos de San Luis Potosí*. México: Instituto Mexicano de Investigaciones Económicas, 192 pp.
- Antrop, M. (2005). Why landscapes of the past are important for the future. *Landscape Urban Plan*, 70, 21–34.
- Bailey, L. L. (2003). Estimating detection probabilities for terrestrials salamanders in Great Smoky Mountains National Park. Dissertation. North Carolina State University. Raleigh, North Carolina, USA.
- Benton, T. G., Vickery, J. A., & Wilson, J. D. (2003). Farmland biodiversity: is habitat heterogeneity the key?. *Trends in Ecology & Evolution*, 18(4), 182-188.
- Bergman, K. O., Askling, J., Ekberg, O., Ignell, H., Wahlman, H. & Milberg, P. (2004). Landscape effects on butterfly assemblages in an agricultural region. *Ecography*, 27, 619–628.
- Berlanga, H. (1991). Las aves frugívoras de Chamela: su recurso vegetal y su papel en la dispersión de semillas. Tesis, Facultad de Ciencias, Universidad Nacional Autónoma de México, México, D.F.
- Brisbin, I. L., Pratt, H. D., & Mobray, T. B. (2002). American Coot (*Fulica americana*). In A. Poole, & F. Gill (Eds.), *The Birds of North America*, No. 697a. Ithaca, New York: The Birds of North America Online.

- Brown, M. T., Cohen, M. J., Bardi, E., & Ingwersen, W. W. (2006). Species diversity in the Florida Everglades, USA: *A systems approach to calculating biodiversity. Aquatic Sciences, 68*, 254-277.
- Burnham, K. P., & Anderson, D. R. (2002). Model selection and multimodel inference: a practical information-theoretic approach. 2^{da} Edition. New York, USA: Springer-Verlag.
- Chapa-Vargas, L., & Monzalvo-Santos, K. (2012). Natural protected areas of San Luis Potosí, Mexico: ecological representativeness, risks, and conservation implications across scales. *International Journal of Geographical Information Science, 26*(9), 1625-1641.
- Charcas-Salazar, H., Aguirre-Rivera, R., & Olivares-Sáenz, E. (2000). Proceso de conformación agrícola de la región de Río Verde, San Luis Potosí, México. *Revista Geográfica, 128*, 105-117.
- Charcas-Salazar, H., & Olivares-Sáenz, E. (2002). Agua de riego en la región de Rioverde, San Luis Potosí, México. *Ingeniería Hidráulica en México, 17*(4), 37-56.
- Clough, Y., Kruess, A., Kleijn, D. & Tscharntke, T. (2005). Spider diversity in cereal fields: comparing factors at local, landscape and regional scales. *Journal of Biogeography, 32*, 2007–2014.
- Collinge, S. K. (2009). Ecology of fragmented landscapes. Baltimore: The Johns Hopkins University Press.
- Comisión Nacional para el Uso y Conocimiento de la Biodiversidad (CONABIO). (2009), Los Peroles.
- Corn, P. S. (2000). Amphibian research and monitoring initiative. *FrogLog, 2000*, 1-2.

- Corser, J. D. (2001). Decline of disjunct green salamander (*Aneides aeneus*) populations in the southern Appalachians. *Biological Conservation*, 97,119-126.
- Dale, V. H., Brown, S., Hobbs, N. T., Huntly, N., Naiman, R. J., Riebsame, W. E., Turner, M. G. & Valone, T .J. (2000). Ecological Principles and Guidelines for Managing the Use of Land. *Ecological Applications*, 10(3), 639-67.
- DeAngelis, D. L., Gross, L. J., Huston, M. A., Wolff, W. F., Fleming, D. M., Comiskey, E. J., & Sylvester, S. M. (1998). Landscape Modeling for Everglades Ecosystem Restoration. *Ecosystems*, 1, 64-75.
- DeFries, R., Jonathan, F., & Asner, G. (2004). Land-use choices: Balancing human needs and ecosystem functions. *Frontiers in Ecology and the Environment*, 2(5), 249-257.
- Dodd, C. K., Corser, J. D., & Griffey, M. L. (2000). Inventory and monitoring the amphibians of Great Smoky Mountains National Park: 1999 progress report. Gainesville, Florida, USA: United States Geo-logical Service, Florida Caribbean Science Center.
- Dunne, P. (2006). Pete Dunne's Essential Field Guide Companion. New York: Houghton Mifflin.
- Ehrlich, P. R., Dobkin, D. S., & Wheye, D. (1988). The Birder's Handbook. New York: Simon & Schuster.
- Environmental Systems Research Institute (ESRI). (2002). ArcView v. 3.3. Redlands, California: Environmental Systems Research Institute.
- Fahrig, L. (2007). Non-optimal animal movement in human-altered landscapes. *Functional Ecology*, 21,1003–1015.
- Farina, A. (2000). Landscape Ecology in Action. Kluwer Academic, London. 169 p.

- Fisher, R. N., & Shaffer, H. B. (1996). The Decline of Amphibians in California's Great Central Valley. *Conservation Biology*, 10(5), 1387-1397.
- Fisher, J.; & Lindenmayer, D. B. (2007). Landscape modification and habitat fragmentation: a synthesis. *Global Ecology and Biogeography*, 16, 265-280.
- García, E. (1988). Modificaciones al sistema de Clasificación Climática de Köppen. México.
- Gibbons, W. J., Burke, V. J., Lovich, J. E., Semlitsh, R. D., Tuberville, T. D., Bodie, J. R., Greene, J. L. et al. (1997). Perceptions of species abundance, distribution, and diversity: lessons from four decades of sampling on a government-managed reserve. *Environmental Management*, 21, 259-268.
- Gibbons, J. W., Scott, D. E., Ryan, T. J., Buhlmann, K. A., Tuberville, T. D., Metts, B. S., Greene, J. L., Mills, T., Leiden, Y., Poppy, S., & Winne, C. T. (2000). The global decline of reptiles, déjà vu amphibians. *Bioscience*, 50,653–666.
- Hecnar, S. J., & M'Closkey, R. T. (1997). The effects of predatory fish on amphibian species richness and distribution. *Biological Conservation*, 79, 123-131.
- Hines, J. E. (2006). PRESENCE2: Software to estimate patch occupancy and related parameters. USGS-PWRC. Available from: <http://www.mbrpwr.usgs.gov/software.html> (accessed May 2014).
- Howell, S. N. G., & Webb, S. (1995). Guide to the Birds of Mexico and Northern Central America. USA: Oxford University Press.
- Hyde, E. J., & Simons, T. R. (2001). Sampling plethodontid salamanders: sources of variability. *The Journal of wildlife management*, 65 (4), 624-632.

- Jackson, B. J., & Jackson, J. A. (2000). Killdeer (*Charadrius vociferus*). In A. Poole (Ed.), *The Birds of North America* (No. 517). Ithaca, New York: The Birds of North America Online.
- Kroodsma, D. E., & Verner, J. (1997). Marsh Wren (*Cistothorus palustris*). In A. Poole, & F. Gill (Eds.). *The Birds of North America*, No. 308. Washington, D.C: The Academy of Natural Sciences, Philadelphia, PA, and The American Ornithologists' Union.
- Mackenzie, D. I., Nichols, J. D., Lachman, G. B., Droege, S., Royle, J. A., & Langtimm, C. A. (2002). Estimating site occupancy rates when detection probabilities are less than one. *Ecology*, 83(8), 2248-2255.
- Mackenzie, D. I., & Bailey, L. L. (2004). Assessing the Fit of Site-Occupancy Models. *American Statistical Association and the International Biometric Society*, 9(3), 300-318.
- Mackenzie, D. I., & Royle, J. A. (2005). Designing occupancy studies: general advice and allocating survey effort. *Journal of Applied Ecology*, 42,1105-1114.
- Mafabi, P. (2000). The role of wetland policies in the conservation of waterbirds: the case of Uganda. *Ostrich*, 71(1-2), 96-98.
- Mendoza, T. O. (1944). *El cultivo del naranjo en Río Verde, S.L.P.* Tesis profesional, Escuela Particular de Agricultura de Ciudad Juárez, Ciudad Juárez, Chihuahua, México, 50 pp.
- Meyer, W. B. (1995). Past and Present Land Use and Land Cover in the USA. *Consequences*, 1(1), 25-33.
- Ogden, J. C. (1994). A comparison of wading birds nesting colony dynamics (1931-1846 and 1974-1989) as an indication of ecosystem conditions in the southern

- Everglades. In S.M. Davis, & J. C. Ogden. (Eds.), *Everglades: the ecosystem and its restoration* (pp. 693-708). Delray Beach, Florida: St Lucie.
- Palacio-Núñez, J., Verdú, J. R., Galante, E., Jiménez-García, D., & Olmos-Oropeza, G. (2007). Birds and fish as bioindicators of tourist disturbance in springs in semiarid regions in Mexico: a basis for management. *Animal Biodiversity and Conservation*, 30 (1), 29–41.
- Palacio-Núñez, J., Olmos-Oropeza, G., Verdú, J. R., Galante, E., Rosas-Rosas, O. C., Martínez-Montoya, J. F., & Enríquez, J. (2010). Traslape espacial de la comunidad de peces dulceacuícolas diurnos en el sistema de humedal Media Luna, Rioverde, SLP, México. *Hidrobiológica*, 20 (1), 21-30.
- Pearson, S. M. (1993). The spatial extent and relative influence of landscape-level factors on wintering bird populations. *Landscape Ecology*, 8, 3–18.
- Pérez-Arteaga, A., & Gaston, K. J. (2004). Status of the american coot *Fulica americana* (Gruiformes: Rallidae) wintering in Mexico. *Acta Zoológica Mexicana*, 20(1), 253-263.
- Petranka, J.W., Eldridge, M.E., & Haley, K.E. (1993). Effects of timber harvesting on southern Appalachian salamanders. *Conservation Biology*, 7, 363–377.
- Pilliod, D. S., & Peterson, C. R. (2001). Local and landscape effects of introduced trout on amphibians in historically fishless watersheds. *Ecosystems*, 4 (4), 322-333.
- Ramsar Bureau. (1999). People and Wetlands: the Vital Link. 7th Meeting of the Conference of the Contracting parties to the Convention on Wetlands (Ramsar, Iran, 1971), San Jose, Costa Rica, 10-18 May, 1999. Gland, Switzerland: Ramsar Bureau.
- Richards, J. F. (1990). Land transformation. In *The Earth as transformed by human*

action (pp. 163–178). New York: Cambridge University Press.

Rivera-Rivera, E., Enríquez, P. L., Flamenco-Sandoval, A., & Rangel-Salazar, J. L. (2012). Occupancy and abundance of nocturnal raptors (*Strigidae*) in the Selva El Ocote Biosphere Reserve, Chiapas, Mexico. *Revista mexicana de biodiversidad*, 83 (3):742-752.

Robinson, R. A. & Sutherland, W. J. (2002). Post-war changes in arable farming and biodiversity in Great Britain. *Journal of Applied Ecology*, 39, 157–176.

Rodenhouse, N. L., Best, L. B., O'Conner, R. J., & Bollinger, E. K. (1995). Effects of agricultural practices and farm- land structures. In T. E. Martin, & D. M. Finch, (Eds.), *Population ecology and conservation of neotropical migrant birds* (pp 269-293). New York, USA: Oxford University Press.

Rodewald, A. D., & Yahner, R. H. (2001). Influence of landscape composition on avian community structure and associated mechanisms. *Ecology*, 82(12), 3493-3504.

Rodríguez-Yáñez, C., Villalón-Calderón, R., & Navarro, A. G. (1994). Bibliografía de las aves de México (1825-1992). *Publnes. Esp. Mus. Zool. (Fac. Cienc. Univ. Nac. Autónoma México)*, 8, 1-146.

Roshier, D. A., Robertson, A. I., & Kingsford, R. T. (2002). Responses of waterbirds to flooding in an arid region of Australia and implications for conservation. *Biological Conservation*, 106, 399-411.

Rzedowski, J. (1965). Vegetación del Estado de San Luis Potosí. *Acta científica potosina*, 5(1-2), 5-249.

SEGAM. (2004). Plan de Manejo del área natural protegida Parque estatal "Manantial de La Media Luna", Secretaria de Ecología y Gestión Ambiental, San Luis Potosí, México, 75 pp.

- Schmidt, M. H., Roschewitz, I., Thies, C. & Tschardtke, T. (2005). Differential effects of landscape and management on diversity and density of ground-dwelling farmland spiders. *Journal of Applied Ecology*, 42, 281–287.
- Shaffer, H. B., Fisher, R. N., & Davidson, C. (1998). The role of natural history collections in documenting species declines. *Trends in Ecology and Evolution*, 13, 27-30.
- Skelly, D. K., Werner, E. E. & Cortwright, S. A. (1999). Long-term distributional dynamics of a Michigan amphibian assemblage. *Ecology*, 80, 2326-2337.
- Stoate, C., Boatman, N. D., Borralho, R. J., Carvalho, C. R., de Snoo, G. R. & Eden, P. (1991) Ecological impacts of arable intensification in Europe. *Journal of Environmental Management*, 63, 337–365.
- Swift, M. J., & Anderson, J. M. (1994). Biodiversity and ecosystem function in agricultural systems. In *Biodiversity and ecosystem function* (pp. 15-41). Berlin Heidelberg: Springer.
- Tews, J., Brose, U., Grimm, V., Tielbörger, K., Wichmann, M. C., Schwager, M. & Jeltsch, F. (2004). Animal species diversity driven by habitat heterogeneity/diversity: the importance of keystone structures. *Journal of Biogeography*, 31, 79–92.
- Thomas, J. A., Bourn, N. A. D., Clarke, R. T., Stewart, K. E., Simcox, D. J., Pearman, G. S., Curtis, R., & Goodger, B. (2001). The quality and isolation of habitat patches both determine where butterflies persist in fragmented landscapes. *Proceedings of the Royal Society of London, Series B*, 268, 1791–1796.
- Tockner, K., & Stanford, J. A. (2002). Riverine flood plains: present state and future trends. *Environmental conservation*, 29, 308-330.

- Tozer, D. C., Nol, E., & Abraham, K. F. (2010). Effects of local and landscape-scale habitat variables on abundance and reproductive success of wetland birds. *Wetlands ecology and management*, 18(6), 679-693.
- Tscharntke, T., Klein, A. M., Kruess, A., Steffan-Dewenter, I. & Thies, C. (2005). Landscape perspectives on agricultural intensification and biodiversity–ecosystem management. *Ecology Letters*, 8, 857–874.
- Velázquez, P. F. (1987). Colección de documentos para la historia de San Luis Potosí, tomo 3, Archivo Histórico del Estado, San Luis Potos. 561 p.
- Verástegui, E. (1979). Rioverde, S. L. P. V. Dominio español y la independencia, Cuadernos, núm. 74, Biblioteca de Historia Potosina, San Luis Potosí. 42 p.
- Weibull, A.C., Östman, Ö. & Granqvist, A. (2003) Species richness in agroecosystems: the effect of landscape, habitat and farm management. *Biodiversity and Conservation*, 12, 1335–1355.
- Welsh, H. H., & Droege, S. (2001). A Case for Using Plethodontid Salamanders for Monitoring Biodiversity and Ecosystem Integrity of North American Forests. *Conservation Biology*, 15 (3), 558–569.
- Wiens, J. A. (1997). Metapopulation dynamics and landscape ecology. In I.A. Hanski, & M.E. Gilpin (Eds.), *Metapopulation biology: ecology, genetics, and evolution* (pp 43–62). San Diego: Academic Press.
- Wilson, J. D., Morris, A. J., Arroyo, B. E., Clark, S. C., & Bradbury, R. B. (1999). A review of the abundance and diversity of invertebrate and plant foods of granivorous birds in northern Europe in relation to agricultural change. *Agriculture, Ecosystems & Environment*, 75(1), 13-30.

Yoccoz, N. G., Nichols, J. D., & Boulinier, T. (2001). Monitoring of biological diversity in space and time. *Trends in Ecology & Evolution*, 16(8), 446-453.

General conclusions

The current study yielded results pertaining to conservation of Mexican waterfowl at several scales ranging from the local to the country-wide extents. At the country-wide scale, Mexican waterfowl species are vulnerable because their distribution ranges are not adequately represented within protected sites, and because many species have restricted distribution ranges. This result partially reflects a lack of planning which is also consistent with the finding that level 1 and 2 Ecoregions represent a small number of Mexican protected non-coastal wetlands (MPNCW). Based on these results, and those from previous studies it can be concluded that it is necessary to promote sites that are similar in species composition, as well as systems of sites with high complementary. Such strategy would likely guarantee diversity for the long-term at the community, population, and the genetic levels of organization. Selecting systems of natural reserves at the extent of an entire country, likely requires not only understanding species distribution patterns, but also how different environmental factors influence biodiversity values. According to the results, the variables that most influence the number of aquatic bird species at the country-wide scale are number of aquatic habitat types, and altitude. Based on this information and that from future studies that would likely focus on fine spatial scales, conservation strategies and management plans could be formulated in order to enhance representation of regional biodiversity, and simultaneously promote economic development for local populations.

At finer scales, in addition to representation, management strategies should consider direct threats within individual sites. These threats are caused by many drivers, and have compromised many ecosystem functions and ecological services of Mexican protected non-coastal wetlands (MPNCW). Though conservation and research actions have contributed to mitigate some effects of direct threats, this benefit has only been partial and/or local. However, at the country level, correlation between types of direct threats, conservation actions, and research conducted so far is at most partial. This result shows that conservation implementation has failed at most local sites presumably due to lack of communication between scientists, managers, and decision makers. Therefore, a new generation of professionals focusing on enhancing communication between different actors would be desirable.

Among the many threats affecting MPNCW, land use change to agriculture is the most common. The results of the current study led to the conclusion that land use changes to agriculture influence occupancy patterns by aquatic bird species of different degrees of vulnerability at least at two spatial scales, local and landscape. *Cistothorus palustris* is the most vulnerable of the three species studied. For this species, local scale effects are more important than landscape scale effects independently of season because it is an obligate to aquatic habitats having well-developed aquatic vegetation. For less vulnerable species, however, the two spatial scales are important, as well as the temporal scale. For this species, occupancy may increase, decrease, or remain stable with increasing percentage of agriculture depending on degree of vulnerability and season. In any case, it appears that for species that are not highly vulnerable, there will always be some

occupied habitat as long as there are some aquatic and terrestrial environments available simultaneously. Therefore, management should focus on the most vulnerable species. Providing aquatic habitat with well-developed aquatic vegetation these species should necessarily be a priority. In spite of the threat that agriculture poses to aquatic systems throughout the country, the results of this study suggested that habitat occupancy may be feasible even for the most vulnerable species as some of the rallids that were registered, even in the presence of some agriculture within the landscape. However, for these highly vulnerable species, large portions of the landscape should be isolated from the agriculture complexes. Finally, it should be stressed that occupancy is not the only diagnostic attribute for healthy populations; land use changes may influence other parameters including density, survival, reproduction, population health, etc. These are topics that deserve further study.

Appendix 1. 78 MPNCW and their physical and biological characteristics

Site name	Area (ha)	Number vegetation types	Level I Ecoregion
(El Jagüey), Buenavista de Peñuelas	35	1	Elevations Southern Semiarid
Laguna Hanson, Parque Nacional Constitución de 1857	510	1	Deserts of North America
Oasis Sierra de La Giganta	155046	2	Warm Humid Forests
Oasis de la Sierra El Pilar	180803	2	Deserts of North America
Humedal Los Comondú	46095	3	Deserts of North America
Baño de San Ignacio	4225	2	Great Plains
Oasis San Ignacio	46.3993	1	Deserts of North America
Lagunas de Montebello	112660	3	Elevations Southern Semiarid
Nahá	3847	1	Warm Humid Forests
Cañón del Sumidero	21789	1	Warm Dry Forests
Humedales de Montaña La Kisst	36	2	Temperate Sierras
Cabildo-Amatal	2832	1	Warm Humid Forests
Humedales La Libertad	5432	2	Warm Humid Forests
Laguna de Babícora	13869.8	3	Elevations Southern Semiarid
Cuatrociénegas	83607.2	3	Temperate Sierras
Nacimiento Río Sabinas y sureste Sierra Santa Rosa	32305.9	1	Deserts of North America
S. Lacustre Ejidos de Xochimilco y S. Gregorio Atlapulco	2657	3	Temperate Sierras
Cañon Fernández	17002	3	Deserts of North America
Laguna de Santiaguillo	380700	1	Deserts of North America
Ciénega de Lerma	7445.69	3	Temperate Sierras
Laguna de Yuriria	14740.1	4	Temperate Sierras
Presa de Silva	3934	2	Elevations Southern Semiarid
Laguna de Tecocomulco	1769	2	Temperate Sierras
Laguna de Metztlán	2937	1	Temperate Sierras
Laguna de Sayula	16800	2	Temperate Sierras
Laguna de Zapotlán	1496	5	Temperate Sierras
Laguna de Atotonilco	2850	5	Elevations Southern Semiarid
Presa La Vega	1950	3	Temperate Sierras
Lago de Chapala	112722	2	Elevations Southern Semiarid

Humedales del Lago de Pátzcuaro	707	1	Temperate Sierras
Laguna de Zacapu	40	4	Temperate Sierras
Alberca de los Espinos	33	2	Temperate Sierras
Lago de Camécuaro	10	3	Elevations Southern Semiarid
Laguna de Hueyapan (El Texcal)	276	1	Warm Dry Forests
Presa Manuel Ávila Camacho (Presa Vaselquillo)	23612	1	Elevations Southern Semiarid
S. Represas y C. biológicos C. hidrográfica del Río Necaxa	1541	2	Temperate Sierras
Presa de Jalpan	68	1	Temperate Sierras
Bala'an K'aax	131610	1	Warm Humid Forests
Laguna de Chichankanab	1999	3	Warm Dry Forests
Arroyos y manantiales de Tanchachín	1174	4	Warm Humid Forests
Ciénega de Tamasopo	1364	1	Warm Humid Forests
Agua dulce (El Pinacate)	39	3	Deserts of North America
Ecosistema Arroyo Verde (Sierra de Álamos)	174	1	Temperate Sierras
Pantanos de Centla	302706	1	Warm Humid Forests
Presa de Atlagantepec	1200	2	Temperate Sierras
Cascadas de Texolo y su entorno	500	3	Temperate Sierras
Lagunas de Zempoala	4790	1	Temperate Sierras
Lagunas de Yalahau	5683	3	Warm Humid Forests
Lago de San Juan de los Ahorcados	1099	1	Deserts of North America
Mapimí	342388	2	Deserts of North America
Janos Nuevo Casas Grandes	99087.5	2	Temperate Sierras
Calakmul	712500	2	Temperate Sierras
Cascada de Agua Azul	2580	1	Warm Humid Forests
Cuenca Baja del Balsas	191649	1	Warm Dry Forests
Cañón del Zopilote	92364.6	1	Temperate Sierras
Cañon de Santa Elena	277210	1	Deserts of North America
Laguna de Jaco	6699.5	1	Warm Dry Forests
El Sabinal	8	1	Temperate Sierras
Sierra Gorda	383567	2	Great Plains
La Michilía	26164.9	2	Temperate Sierras
Montes azules	1085140	4	Temperate Sierras
Presa Vicente Guerrero	90501.3	1	Temperate Sierras
Presa Temascal	48086.8	2	Great Plains
Presa Cajón de Peñas	2647.48	1	Warm Humid Forests

Laguna del Castillo	306.484	2	Warm Dry Forests
Presa el Tulillo	569.125	2	Temperate Sierras
La Mintzita	57	2	Temperate Sierras
Sistema Lagunar Catazajá	41059	3	Warm Humid Forests
Oasis San Pedro de la Presa	83.4747	1	Deserts of North America
Ciénega de Tláhuac	2860.32	3	Temperate Sierras
Oasis La Purisima y San Isidro	866.416	1	Deserts of North America
Presa Venustiano Carranza	19997.9	1	Temperate Sierras
Lago de Texcoco	15106.3	1	Great Plains
Lago de Mexicanos	4728.78	2	Warm Dry Forests
Lago de Bustillos	9593.12	2	Temperate Sierras
Lago de Cuitzeo	145829	4	Temperate Sierras
Los Novillos	42	1	Great Plains
Cuenca del Río Yaqui	671652	3	Warm Dry Forests

Appendix 2. 78 MPNCW and their administrative and management features

Site name	State	Decree	Year of decree	Year of management plan
(El Jagüey), Buenavista de Peñuelas	Ags	R	2011	na
Laguna Hanson, Parque Nacional Constitución de 1857	BC	R	1962	2011
Oasis Sierra de La Giganta	BCS	R	1996	2003
Oasis de la Sierra El Pilar	BCS	R	2008	na
Humedal Los Comondú	BCS	R	2008	na
Baño de San Ignacio	NL	R	2009	2001
Oasis San Ignacio	BCS	IBA 92	1999	na
Lagunas de Montebello	Chis	R IBA 165 NPA 364	1959	2007
Nahá	Chis	R NPA 377	1998	2009
Cañón del Sumidero	Chis	R NPA 349	1980	2009
Humedales de Montaña La Kisst	Chis	R	2008	na
Cabildo-Amatal	Chis	R	2008	na
Humedales La Libertad	Chis	R	2008	na
Laguna de Babícora	Chih	R IBA 60	2008	1995
Cuatrociénegas	Coah	R IBA 72 NPA 351	1994	1999
Nacimiento Río Sabinas y sureste Sierra Santa Rosa	Coah	IBA 65 R	1999	2002
S. Lacustre Ejidos de Xochimilco y S. Gregorio Atlapulco	DF	R	2004	2008
Cañon Fernández	Dgo	R	2008	2003
Laguna de Santiaguillo	Dgo	IBA 75	1999	na
Ciénega de Lerma	Méx	R IBA 9 NPA 265	1999	na
Laguna de Yuriria	Gto	R IBA 56	2004	na
Presa de Silva	Gto	R	2011	1998
Laguna de Tecocomulco	Hgo	R IBA 224	2003	na
Laguna de Metztlán	Hgo	R NPA 250	2000	2003
Laguna de Sayula	Jal	R	2004	na
Laguna de Zapotlán	Jal	R	2005	na
Laguna de Atotonilco	Jal	R	2006	na
Presa La Vega	Jal	R	2010	2008
Lago de Chapala	Jal	R IBA 58	2009	na
Humedales del Lago de Pátzcuaro	Mich	R IBA 3	1995	na
Laguna de Zacapu	Mich	R	2005	na
Alberca de los Espinos	Mich	R	2009	na

Lago de Camécuaro	Mich	NPA 297	1941	na
Laguna de Hueyapan (El Texcal)	Mor	R	2010	2005
Presa Manuel Ávila Camacho (Presa Vaselquillo)	Pue	R	2012	na
S. Represas y C. biológicos C. hidrográfica del Río Necaxa	Hgo-Pue	R	1938	na
Presa de Jalpan	Qto	R	2004	1999
Bala'an K'aax	QR	R NPA 248	2004	2007
Laguna de Chichankanab	QR	R	2004	na
Arroyos y manantiales de Tanchachín	SLP	R	2008	na
Ciénega de Tamasopo	SLP	R NPA 265	2008	na
Agua dulce (El Pinacate)	Son	R	1993	1996
Ecosistema Arroyo Verde (Sierra de Álamos)	Son	R NPA 330	2007	na
Pantanos de Centla	Tab	R IBA 156 NPA 376	1995	2000
Presa de Atlagantepec	Tlax	R	2009	na
Cascadas de Texolo y su entorno	Ver	R	2006	na
Lagunas de Zempoala	Méx	NPA 299	1936	2011
Lagunas de Yalahau	Yuc	R	1999	2004
Lago de San Juan de los Ahorcados	Zac	R	2009	na
Mapimí	Chih	IBA 135 NPA 385	1999	2006
Janos Nuevo Casas Grandes	Chih	IBA 133	1999	2012
Calakmul	Camp	IBA 171 NPA 345	1989	2000
Cascada de Agua Azul	Chis	NPA 258	1980	na
Cuenca Baja del Balsas	Mich	IBA 23	1999	na
Cañón del Zopilote	Gro	IBA 18	1999	na
Cañón de Santa Elena	Chih	NPA 254	1994	2012
Laguna de Jaco	Chih	IBA 136	1999	na
El Sabinal	NL	NPA 278	1938	na
Sierra Gorda	Qto	IBA 6 NPA 370	1997	2000
La Michilía	Dgo	IBA 79 NPA 363	1979	na
Montes azules	Chis	IBA 163 NPA 374	1978	2000
Presa Vicente Guerrero	Tamps	IBA 83	1999	na
Presa Temascal	Oax	IBA 202	1999	na
Presa Cajón de Peñas	Jal	IBA 59	1999	na
Laguna del Castillo	Ver	IBA 198	1999	na

Presa el Tulillo	Coah	IBA 71	1999	na
La Mintzita	Mich	R	2009	na
Sistema Lagunar Catazajá	Chis	R	2008	2006
Oasis San Pedro de la Presa	BCS	IBA 143	1999	na
Ciénega de Tláhuac	DF	R IBA 37	1999	na
Oasis La Purisima y San Isidro	BCS	IBA 142	1999	na
Presa Venustiano Carranza	Coah	IBA 66	1999	na
Lago de Texcoco	DF	IBA 1	1999	na
Lago de Mexicanos	Chih	IBA 61	1999	na
Lago de Bustillos	Chih	IBA 62	1999	na
Lago de Cuitzeo	Mich	IBA 2	1999	na
Los Novillos	Coah	NPA 303	1940	na
Cuenca del Río Yaqui	Son	IBA 127	1999	na

Ags=Aguascalientes, BC=Baja California, BCS=Baja California Sur, Camp=Campeche, Chis=Chiapas, Chih=Chihuahua, Coah=Coahuila, DF=Distrito Federal, Gto=Guanajuato, Gro=Guerrero, Hgo=Hidalgo, Jal=Jalisco, Méx=México, Mich=Michoacán, Mor=Morelos, NL=Nuevo León, Oax=Oaxaca, Pue=Puebla, Qto=Querétaro, QR=Quintana Roo, SLP=San Luis Potosí, Son=Sonora, Tab=Tabasco, Tamps=Tamaulipas, Tlax=Tlaxcala, Ver=Veracruz, Yuc=Yucatán, Zac=Zacatecas, R=Wetlands of International Importance, NPA=Natural Protected Area, IBA=Areas of Importance for the Conservation of Birds of Mexico, and na=non applicable.