

© 2018 IEEE. Personal use of this material is permitted. Permission from IEEE must be obtained for all other uses, in any current or future media, including reprinting/republishing this material for advertising or promotional purposes, creating new collective works, for resale or redistribution to servers or lists, or reuse of any copyrighted component of this work in other works.

This is the Author's Pre-print version of the following article: *I. A. Diaz-Diaz and E. Campos-Canton, "Design of an Electrowetting Biosensor Prototype Controlling Microfluidic Droplet Movement for Isothermal Nucleic Acid Amplification Assays," 2018 IEEE International Autumn Meeting on Power, Electronics and Computing (ROPEC), Ixtapa, Mexico, 2018, pp. 1-4.* To access the final edited and published work is available online at: <https://doi.org/10.1109/ROPEC.2018.8661451>

Design of an Electrowetting Biosensor Prototype Controlling Microfluidic Droplet Movement for Isothermal Nucleic Acid Amplification Assays

Irwin A. Diaz-Diaz, Eric Campos-Canton

Nonlinear Dynamics and Chaos Laboratory, Applied Mathematics Division
Institute for Scientific and Technological Research of San Luis Potosi (IPICYT)

Camino a la Presa San Jose 2055, Col. Lomas 4ta Seccion

C.P. 78216, San Luis Potosi, SLP, Mexico

Email: {irwin.diaz,eric.campos}@ipicyt.edu.mx, http://www.ipicyt.edu.mx

Abstract—In this paper, the functioning and the operation of an electrowetting device to manipulate droplets is described. The prototype is built on a printed circuit board (PCB) and consists of an electrode array selected and energized by a microcontroller or switches. Each electrode can be manipulated to perform the sequence of steps required to carry out isothermal amplification. Laboratory tests have shown that droplets of 15 μL can be moved on the PCB surface. The system efficiency depends on the hydrophobic surface and the voltage applied to the electrodes as well as the switching frequency of the electrodes. This device is the first prototype of the desired biosensor under development.

Keywords—*microfluidic, Lab-on-chip, electric field, electrowetting.*

I. INTRODUCTION

Cancer is one of the leading causes of death in Mexico and the world. In 2015, cancer deaths were ranked third in Mexico and those caused by cervical cancer by certain types of human papillomavirus (HPV) called high-risk were the second cause of cancer death among women [1]. Infection by high-risk HPV types is usually diagnosed through the amplification of some of the viral genes from the DNA of the cervix of patients through the polymerase chain reaction (PCR). The PCR assays are carried out through 30 to 40 programmed incubation cycles, each of which involves temperature changes of 95°C, \sim 65°C and 52°C of controlled duration. These tests also require well-equipped laboratories, specialized personnel and programmable thermocyclers that perform the amplification cycles automatically.

In the last decades, nucleic acid amplification systems alternative to PCR have been being developed under isothermal conditions (i.e., at a single temperature close to room temperature) without thermocyclers. Among these systems stand out the SP-RCA tests with padlock probes (SP) [2] amplified isothermally by the rolling circle mechanism (RCA) [3], which have been developed within this project for the detection of the four most prevalent types of high-risk HPV.

However, PCR assays cannot be performed at the point of care (POC) because they require well-equipped laboratories, thermocyclers, and specialized personnel. This project aims to develop a low-cost, portable biosensor that may be used by inexperienced personnel at the POC to perform isothermal

amplification assays based on padlock probes for the detection of high-risk HPV types.

In recent years, the idea of developing integrated miniaturized systems to perform chemical and/or biological analysis has emerged. The technology of these systems is based on the automatic manipulation of a liquid electrolyte microsamples. Moreover, the purpose of these systems is to reproduce the most common procedures and laboratory equipment for microanalysis formats [4], [9]. The technology of the proposed systems is based on the automatic manipulation of electrolyte liquid microsamples. To have a prototype which accelerates the process of mixtures and compounds as well as cheapening the use of laboratory materials can directly impact society. The application of this laboratory prototype is the first stage to develop a biosensor that facilitates the detection of HPV economically and reliably. The system is intended to mix and to separate the chemicals needed to reveal the presence of HPV in cells. To develop such a sensing system, we are currently working in the design of a microfluidic prototype capable of moving, mixing, and splitting microdroplets using controlled electrowetting [4].

This paper is organized as follows, the electrowetting principle, the proposed system, as well as the implemented prototype are described in Section II. Laboratory tests and some issues regarding the implementation of the prototype are described in Section III. Finally, Section IV presents some conclusions and future work.

II. MATERIALS AND METHODS

Droplet spreading and oscillation on a solid substrate have attracted considerable research interest due to its importance in different engineering applications, such as droplet-based microfluidics [5], optofluidic optical attenuators [6], [7] and reflective displays [8], among many others. Between distinct approaches to control the droplet motion, electrowetting (EW) is particularly appropriate and functional for its ability to tune the surface wetting property with an external electric field.

A. Electrowetting technology

Electrowetting (EW) is the phenomenon whereby an electric field changes the wetting behavior, i.e., contact angle, of

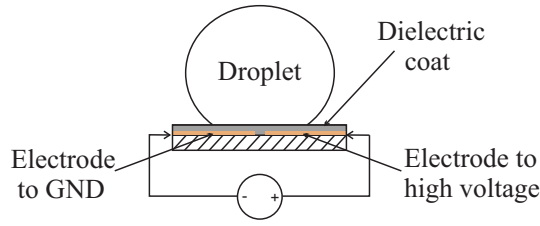

Figure 1. Open configuration device.

a conductive or polarizable liquid droplet in contact with a hydrophobic, insulated electrode. In other words, EW is the electrostatic modulation of the surface tension between the solid (electrode) and the liquid interface (drop), providing a high level of control on the surface of the substrate. EW originates from the electrical force concentrated at the three-phase contact line, which causes the apparent contact angle, θ_{app} , to deviate from the inherent equilibrium value, θ_e . The Young-Lippmann equation can describe the EW-induced contact angle variation.

$$\cos \theta_e + \frac{\epsilon_0 \epsilon_r}{2d\sigma_{lv}} V^2, \quad (1)$$

where ϵ_0 is the vacuum permittivity constant, ϵ_r the relative permittivity of the insulating dielectric layer, d the thickness of the dielectric layer, σ_{lv} the surface tension of the liquid-vapor interface, and V the applied voltage.

Electrowetting on dielectric (EWD) is used for microfluidic devices that operate using the EW principle for droplet movement on a coated electrode. The main limitation of the EWD devices is the droplet volume and the movement, both depend on the electrode side and shape. Also, the handling of the drops is restricted to the regions where the electrodes are coated.

Depending on the number of substrates used and the application of the electric field, EWD devices can be classified into two configurations, open or closed. In Fig. 1 the open configuration is shown. The open configuration has only one substrate, and the external voltage is applied to the sides. The closed configuration device has a pair of substrates separated by a spacer, and the drops are interspersed between the substrates. The external voltage is applied to the lower substrate; the upper substrate is grounded. The open configuration has the advantage of facilitating the interconnection of the ED device with other microfluidic structures, as in the chip deposits, increasing its versatility for biochemical analysis [10]. Moreover, the open configuration can manipulate droplets of greater volume with small electrodes, e.g., droplets of 1.5 – 3 μL can be manipulated with electrodes of 1x1 mm. On the other hand, it has been reported that mixing is more efficient in open configuration devices than in close configuration devices [11].

Generally, ED devices are manufactured using metal layers and photolithographic procedures. The metal layer is engraved to form individually addressable positions called electrodes. The size of an electrode defines the size or volume of the droplet that is used. The electrode layer is coated with an insulating dielectric layer and a hydrophobic layer. The droplet

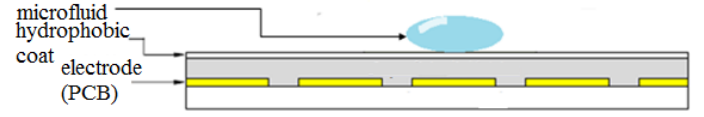

Figure 2. Single plate electrowetting scheme.

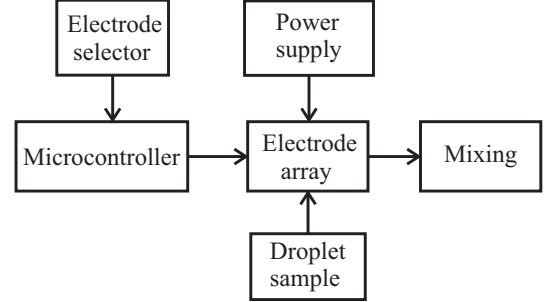

Figure 3. Block diagram of the proposed system.

to be manipulated is placed on the isolated dielectric layer of the electrode. The EW is influenced by the droplet only when it is superimposed on the adjacent electrodes. In Fig. 2 is shown the EW scheme on a simple plate.

The movement of the droplet comprises several factors such as *i*) the contact angle of the drop with the surface of the electrode, *ii*) the activation voltage, *iii*) the speed of movement, among others [12].

A fast prototyping technique to fabricate an EW device is to use a printed circuit board (PCB) commercially available. This method is fast, economical and easy compared with the traditional methods of microfabrication such as lithography, micromachinery, among others.

B. Proposed system

The implemented system is conformed by an electrodes activation stage, the activation of each electrode can be manual or preprogrammed in a microcontroller, and a power supply responsible for supplying the required voltage to each electrode to create an electric field. The block diagram of the proposed system for the current application is shown in Fig 3.

DC/DC converter

Each of the electrodes can be activated independently by a selector connected to a microcontroller. The operation of the circuit and the pulse generator that active the switches (MOSFET) are performed in the microcontroller. The output voltage of the microcontroller is 5 V; however, this voltage level is not sufficient to manipulate the droplets. As a way to overcome the aforementioned problem, a DC/DC converter capable of supplying a voltage of direct current (DC) from 0 to 500 V can be used. This voltage level is required to generate the electric field necessary to move the droplet from one electrode to another. A square signal is generated with the microcontroller to energize the electrodes. Droplet motion can be preprogrammed or controlled in real-time by push-buttons. It is worth noting that the prototype does not require a considerable amount of current to generate the electric field in

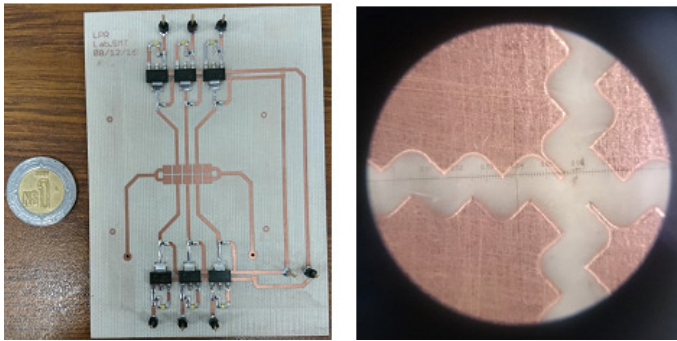

Figure 4. Prototype (left) and electrodes shape (right).

the electrodes, taking into account this a DC/DC converter is selected. The model of the chosen DC/DC converter is EMCO F05, which is an isolated and proportional DC to high voltage DC converter. The output voltage is proportional to input voltage allowing to explore the droplets movement behavior under different voltage levels.

MOSFETs

A P-channel MOSFET activates each electrode. The model of the selected MOSFET is TP2540 which has a low input capacitance and is compatible with logic level interfaces, TTL or CMOS; any driver is not needed to activate the MOSFET simplifying the circuit design and reducing the cost. The drain to source current of the MOSFET is limited connecting a ten $k\Omega$ resistor between the DC/DC converter and the MOSFET drain terminal, in that way any damage in the converter or the MOSFET due to a high current is avoided.

PCB

The prototype has been made off in a standard, FR-4, single-sided PCB taking into account the following, *i*) components are placed as close as possible to the microcontroller connections, *ii*) right angles are avoided to avoid noise pick up and *iii*) a bulk capacitor is placed between the power supply and the PCB connection. The PCB was made using an LPKF machine, model Protomat M60. The prototype is energized by an external power supply of 12 V; it has six MOSFETs connected to six electrodes for droplet manipulation. Furthermore, the prototype has six LEDs that turn on when an electrode is energized. The finished prototype is shown in Fig. 4. The architecture of the device comprises an array of electrodes covered by a dielectric and a hydrophobic layer. The electrodes allow the creation of an electric field using electric potential differences. The movement of the droplets is given by energizing the electrodes by switching the MOSFETs with frequency variations ranging from 10 Hz to 1 kHz. The switch activation signal is generated in the microcontroller.

III. LABORATORY TESTS

The experimental set up for testing the movement of the droplet on the PCB surface is shown in Fig. 5. As we can see, the experimental set up has a DC/DC converter, labeled as power supply, the selectors to energize each electrode in manual operation are mounted on a PCB, an Arduino Uno microcontroller is used for programmed movement, and six

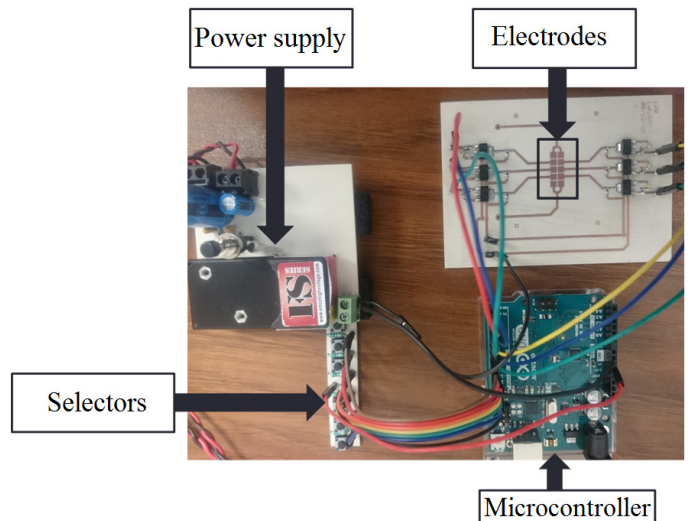

Figure 5. Experimental set up.

copper electrodes with their respective LEDs are in another PCB. Copper electrodes are covered with plastic adherent to wrap food, with a thickness of $\sim 15 \mu\text{m}$, cut in a suitable size and coating the top of the electrodes. Plastic is preferred instead of different materials such as parafilm because of its thickness and greater increase of effective capacity across the dielectric layer; also, it is cheap and easy to obtain. A thin layer of peanut oil is spread on the electrodes to prevent the formation of air bubbles between the electrodes and the plastic. Once the plastic is placed over the electrodes, a thin layer of oil is spread on top of the plastic. In this way, a hydrophobic surface is obtained.

A $15 \mu\text{L}$ droplet is placed on the PCB surface with a variable volumetric pipette (micropipette). In Fig. 6 is shown how the droplet is placed on the surface of the PCB. In order to obtain movement, the droplet must bridge two adjacent electrodes and, the liquid of the droplet must be polarizable and conductible. The movement of the droplet is done by applying a voltage of approximately 120 V at the electrode, while the adjacent ones remain at 0 V, GND. In this way, the droplet moves towards the activated electrode (energized). Ideally, when the electrode is not energized, the contact angle between the droplet and the electrode is large, this angle decreases when an electric field is applied. When this happens, the droplet can be moved quickly from one position (electrode) to another adjacent one.

The movement of a $15 \mu\text{L}$ droplet moving through three electrodes is shown in Fig. 7. Initially, the droplet is placed in the central upper electrode (Fig. 7a), then it moves to the electrode on the right (Fig. 7b). As we can see, the droplet is deformed, in the shape of an oval, when making the movement to the next electrode that want to carry. Finally, Fig. 7c shows the droplet in its path towards the below electrode.

IV. CONCLUSIONS

The movement of a droplet can be controlled with the developed prototype. The developed prototype can manipulate the movement of droplets of $10 \mu\text{L}$. The effectiveness of

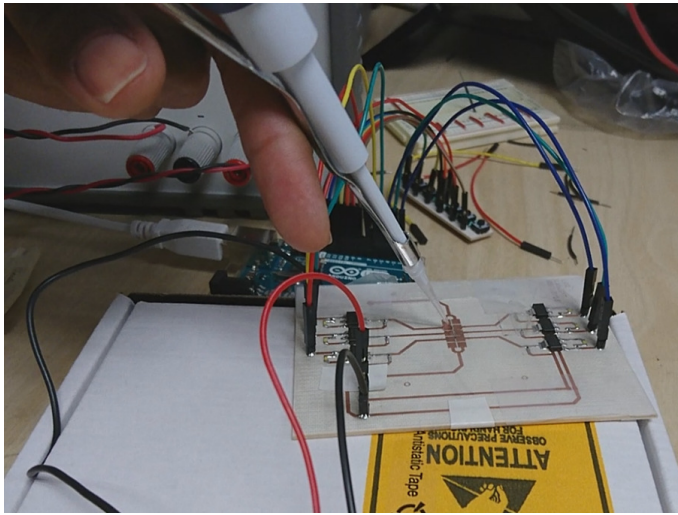

Figure 6. Droplet placement on the PCB surface.

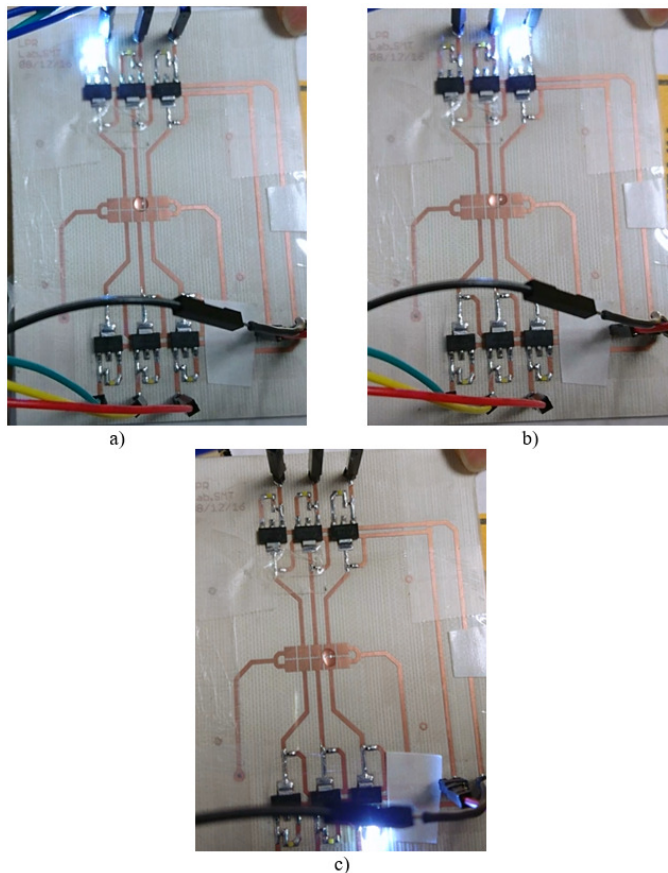

Figure 7. Droplet movement on the PCB surface.

the system depends on the voltage at the electrodes and the switching frequency of the MOSFETs. This device is the beginning of a biosensor under development. In addition to the movement of the droplets, it is necessary to mix them with other chemical components, subject them to different temperatures and, finally separate them, in order to finish the process of HPV detection.

The threshold voltage can be further reduced by increasing the dielectric constant of the hydrophobic layer. Voltage sources, such as AA lithium batteries, can be used if the required threshold voltage is less than 10 V. Miniaturization of the voltage source (6 V, AA lithium battery) is essential to achieve device portability. The significant reduction in droplet acting voltage together with the improved capability of multi-axial low voltage manipulation is a step towards obtaining a digital microfluidic device. Nowadays, we are investigating how the electrode geometry (shape) and the change of gap between the electrodes affects the droplet movement.

ACKNOWLEDGMENT

Authors would like to acknowledge CONACYT for the financial support grant 216315 and Mireya Sanchez for her technical support during the tests.

REFERENCES

- [1] OMS (2016) Human papillomavirus (HPV) and cervical cancer. Organización Mundial de la Salud.
- [2] Nilsson M, Malmgren H, Samiotaki M, Kwiatkowski M, Chowdhary B, Landegren U (1994) Padlock probes: circularizing oligonucleotides for localized DNA detection. *Science* 265:2085.
- [3] Banér J, Nilsson M, Mendel-Hartvig M, Landegren U (1998) Signal amplification of padlock probes by rolling circle replication. *Nucleic Acids Research* 26:5073.
- [4] Pollack M; Fair R; Shenderov A; (2002). Electrowetting-based actuation of liquid droplets for microfluidic applications. *Appl. Phys. Lett.*, vol. 77, no. 11, pp. 1725-1726, Jul 2000.
- [5] F. Mugele, J.C. Baret, Electrowetting: from basics to applications, *J. Phys. Condens. Matter* 17 (28) (2005) R705–R774.
- [6] S. Kuiper, B.H.W. Hendriks, Variable-focus liquid lens for miniature cameras, *Appl. Phys. Lett.* 85 (7) (2004) 1128–1130.
- [7] T. Roques-Carmes, R.A. Hayes, L.J.M. Schlangen, A physical model describing the electro-optic behavior of switchable optical elements based on electrowetting, *J. Appl. Phys.* 96 (11) (2004) 6267–6271.
- [8] R.A. Hayes, B.J. Feenstra, Video-speed electronic paper based on electrowetting, *Nature* 425 (6956) (2003) 383–385.
- [9] Mastrangelo C.H; Burns M.A; Burke D.T. Microfabricated devices for genetic diagnostics. *Proc. of IEEE*, 86(8):1769–1787, 1998.
- [10] S.-Y. Park, S. Kalim, C. Callahan, M. A. Teitell, and E. P. Y. Chiou, "A light-induced dielectrophoretic droplet manipulation platform," *Lab Chip*, vol. 9, no. 22, pp. 3228–3235, 2009.
- [11] C. Cooney, C.-Y. Chen, M. Emerling, A. Nadim, J. Sterling, *Microfluid. Nanofluid.* 2006, 2, 435.
- [12] Li Y; Chen R; Baker R; (2014). A Fast Fabricating Electrowetting Platform to Implement Large Droplet Manipulation. In Proceedings of the 57th Midwest Symposium on Circuits and Systems. IEEE: College Station, 2014.